

Feedforward Control under the Presence of Uncertainty*

Audun Faanes^{1,2} and Sigurd Skogestad¹

¹Department of Chemical Engineering, Norwegian University of Science and Technology, N-7491 Trondheim, Norway;
²Statoil ASA, TEK, Process Control, N-7005 Trondheim, Norway

In this paper, we study the effect of model errors on the performance of feedforward controllers. In accordance with the sensitivity function for feedback control, we define the feedforward sensitivities, S_{ff} (feedforward from disturbance) and $S_{ff,r}$ (feedforward from setpoint), as measures for the reduction in the output error obtained by the feedforward control. For "ideal" feedforward controllers based on the inverted nominal model, the feedforward sensitivities equal the relative model errors, which must thus remain less than 1 for feedforward control to have a positive (dampening) effect. For some common model error classes we provide rules for when the feedforward controller is effective, and we also design μ -optimal feedforward controllers.

Keywords: Feedforward Control; Linear Systems; Process Control; Uncertainty

1. Introduction

There is a fundamental difference between feedforward and feedback controllers with respect to their sensitivity to uncertainty. Feedforward control is sensitive to uncertainty in general (including steady

state), whereas feedback control is insensitive to uncertainty at frequencies within the system bandwidth. With no model error, a feedforward controller may remove the effect of disturbances, but due to its dependence of the process model, it may actually amplify the effect of a disturbance if the model is faulty.

Textbooks on control and process control focus mainly on feedback controllers. This reflects the difference in importance and popularity of the two controllers, but also that feedback theory is more complicated. Most of the articles on feedforward control refer to industrial applications. However, some control textbooks, for example, Buckley (1964), Stephanopoulos (1984), Doebelin (1985), Seborg et al. (1989), Middleton and Goodwin (1990), Coughanowr (1991), Marlin (1995), Ogata (1996), and Shinskey (1996), describe feedforward controllers and their design, and the advantages and disadvantages compared to feedback is discussed. It is concluded that a feedforward controller may improve the performance, and is valuable when feedback control is not sufficient, but that in practice it must be combined with a feedback controller. It is agreed that the feedforward controller is most efficient if good disturbance measurements and accurate models are available, but no quantitative analysis is given (with some exceptions as given in the following). Harriott (1964) claims that in a "typical system" the disturbance effect is reduced to 20%. Middleton and Goodwin (1990) demonstrate that the variation in the gain from the inputs to the

*Also presented at *European Control Conference, ECC'03, 1-4 September 2003, Cambridge, UK*
Correspondence and offprint requests to: S. Skogestad, Department of Chemical Engineering, Norwegian University of Science and Technology, N-7491 Trondheim, Norway. E-mail: skoge@chemeng.ntnu.no

Received 13 December 2002; Accepted 8 October 2003.
Recommended by M. Steinbuch and G. Dumont.

outputs (the process uncertainty) is amplified with feedforward control. Shinskey (1996) states that the integrated error of the output signal can be reduced by a factor of 10 even if the feedforward calculation has 10% error, and that mass- and energy balance based feedforward controllers typically has less than 2% error, leading to a reduction in integrated output error with a factor of 50. Shinskey also provides an interesting figure showing nine different responses to disturbance steps for a process with a pure gain (static) feedforward controller. The nine cases are the combinations of neglected time constants and delays in the transfer functions from the disturbance and the manipulated variable to the output (Shinskey, 1996, Figure 7.12). The figure may also be used for dynamic feedforward controllers as a qualitative illustration of the effect of errors in delays or time constants on disturbance step responses. (Note that Shinskey assumes that the disturbance has a negative effect on the output, in contrast to what we assume in the present paper.)

In the context of internal model control (IMC), Morari and Zafiriou (1989) recommend a structure for the combined feedback-feedforward scheme that decouples the two functions such that the feedforward controller handles disturbance dampening and the feedback controller handles reference tracking. This is exploited in the controller tuning (assuming perfect models) since the two controllers can be tuned independently. The traditional controllers can then be derived from these controllers and the process models. It is shown that assuming perfect models, optimal feedforward can only be better than optimal feedback if there are non-minimum phase components (such as delays and inverse responses) in the process.

Scali and co-workers (Lewin and Scali 1988, Scali et al. 1989) also work in the IMC context and compare the control error of \mathcal{H}_2 optimal feedback controllers with an \mathcal{H}_2 optimal combination of feedback and feedforward controllers under the presence of uncertainty. The motive is to make a fair comparison, and to give methods for identifying when feedforward is worth the effort, and to quantify the benefits from accurate models. Uncertainty representations, similar to the ones we will discuss, are used. Numerical results for parametric uncertainty in first-order processes with delay are presented for different nominal values and uncertainties. Even for this simple case the picture gets rather complicated, as there are many parameters that must be varied to cover all cases, both nominal parameters as well as the parameters representing the uncertainty, so it is difficult to present the results and give general quantitative answers. The overall conclusion is that feedforward may make the

performance poorer if the response to the manipulated input is considerably faster than the disturbance response and the uncertainty is large for the model of the disturbance effect.

Marlin (1995) studies the effect of model errors (one at a time) by comparing combined feedforward and feedback control with the response when pure feedback is applied. The response to a disturbance step for a first-order process with delay is the criterion for the comparison. From his example the feedforward reduces the control error with more than 50% for parametric errors up to $\pm 50\%$.

A general quantitative frequency domain analysis of feedforward control under model uncertainty is proposed by Balchen (1968) (and referred in Balchen and Mummé 1988).

The aim of this paper is to study feedforward control under the presence of uncertainty and answer the following basic questions:

1. How much does the feedforward controller reduce the control error?
2. When is the feedforward controller amplifying the effect of disturbances on the outputs?
3. If combined with feedback control, when is feedforward control necessary (and useful)?
4. How can uncertainty be taken into account when the feedforward controller is designed?

The outline of the paper is as follows. We first recapitulate the characteristics of feedforward control (Section 2), and then define feedforward sensitivities (Section 3). We then discuss the effect of model errors under feedback and feedforward control, that is, answer questions 1 and 2 (Section 4) and study some classes of model uncertainty in Section 5. We illustrate some of the ideas with an example (Section 6). Question 3 is discussed in Section 7. Proposals to answers of Question 4 are given in Section 8. The paper is concluded in Section 9.

2. The Characteristics of Feedforward Control

A block diagram where feedforward from a disturbance and the reference is combined with feedback, is shown in Fig. 1. To analyze the effect of a given feedforward controller, we denote the feedback controller K and the feedforward action from the disturbance K_{ff} and the reference $K_{ff,r}$. With perfect measurements we then have (see Fig. 1),

$$u = \underbrace{K(y_r - y)}_{\text{Feedback}} + \underbrace{K_{ff,r}y_r - K_{ff}d}_{\text{Feedforward}}. \quad (1)$$

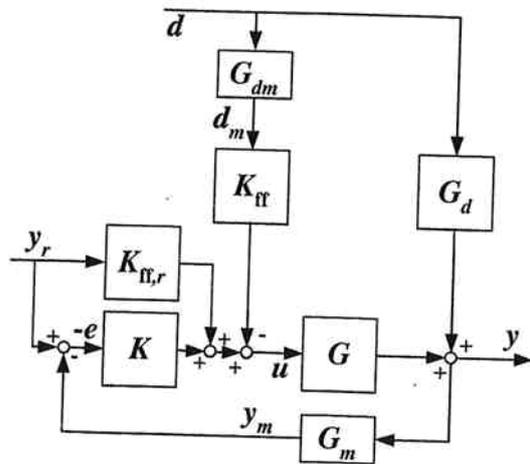

Fig. 1. Block scheme for feedforward control combined with a feedback controller. We assume ideal measurements: $G_{dm} = 1$ and $G_m = 1$.

Some important characteristics of the "traditional" feedforward controller are:

1. The basic task of a feedforward controller (K_{ff} and $K_{ff,r}$) is to use the process input, u , to reduce the effect of measured disturbances and improve set-point tracking.
2. Feedforward control is "open loop" since the disturbance measurement, d_m , and the reference y_r (which are used by the feedforward controller) are independent of u .
3. For linear systems, the feedforward controller does not influence the stability of the system.
4. The feedforward controller uses a model of the process (G and G_d). If the model is faulty, then the controller based on this faulty model will not yield the desired performance, and the controller may even amplify the effect of the disturbance.
5. Normally the effect of the disturbance is observed earlier in the disturbance measurement than in the other process measurements.
6. Referring to Fig. 1, the closed loop response for the combination of feedforward and feedback control is

$$\begin{aligned} e(s) &= y(s) - y_r(s) \\ &= S(s)(G_d(s) - G(s)K_{ff}(s))d(s) \\ &\quad - S(s)(I - G(s)K_{ff,r}(s))y_r(s) \end{aligned} \quad (2)$$

where $S(s) = (I + G(s)K(s))^{-1}$ is the feedback sensitivity function.

2.1. Ideal Feedforward Control

An "ideal" feedforward controller, which is based on inverting the nominal model (e.g. Balchen 1968, Balchen and Mummé 1988, Morari and Zafiriou 1989), removes completely the effect of the disturbance and reference changes such that $e(s) \equiv 0$. We denote the "ideal" controller with an asterisk, and get from (2)

$$K_{ff}^* = G^{-1}G_d; \quad K_{ff,r}^* = G^{-1}. \quad (3)$$

Designs of robustly optimized (μ -optimal) feedforward controllers presented later in this paper confirm that this is a good controller as to use in some practical cases. However, there are three reasons why ideal feedforward control ($e=0$) may not be achieved in many cases:

- (a) The ideal feedforward controller in (3) may not be realizable. First, if G is non-minimum phase, it cannot be inverted. Second, if G has more poles than zeros, for example, $G = 1/(\tau s + 1)$, the inverse is improper and requires differentiation. Because of measurement noise, higher-order derivatives are normally avoided (Harriott 1964). Thus, we divide G into a (practically) invertible part, G_- , and a not invertible allpass part, G_+ , such that $G = G_-G_+$ (Holt and Morari 1985a,b). Morari and Zafiriou (1989) derive the \mathcal{H}_2 -optimal feedforward controller (in the context of IMC). A simpler alternative that we will use here is

$$K_{ff}^+ = G_-^{-1}G_d; \quad K_{ff,r} = G_-^{-1}. \quad (4)$$
 (4) has an optimal \mathcal{H}_2 -norm (\mathcal{H}_2 -optimal for impulse disturbances on the output, $G_d = I$, and impulses in the reference).
- (b) The ideal feedforward controller in (3) is also not realizable if the number of outputs exceeds the number of manipulated inputs (the length of y exceeds the length of u). One must then control the (most) important outputs (reducing the length of y till it equals the length of u), or find some compromise between the outputs, for example, use the pseudo-inverse of G .
- (c) The model used in the design of the feedforward controller differs from the actual plant. This is the main topic of this paper.

3. Feedforward Sensitivity Functions

The closed loop response for combined feedforward and feedback control in (2) may be

rewritten as follows

$$e = S(S_{ff}G_d d - S'_{ff,r}y_r), \quad (5)$$

where we define the *feedforward sensitivities* as

$$S_{ff} = (I - GK_{ff}G_d^\dagger), \quad (6)$$

$$S'_{ff,r} = I - GK_{ff,r}. \quad (7)$$

These express the effect of feedforward action on the control error. G_d^\dagger denotes the generalized inverse of G_d (e.g. Zhou et al. 1996, p. 67). Feedback control is effective and improves performance as long as the gain of the sensitivity function $\|S\| < 1$. Similarly, feedforward control improves the performance if

$$\|S_{ff}\| < 1 \quad \text{and} \quad \|S'_{ff,r}\| < 1. \quad (8)$$

Here, an appropriate norm dependent on the definition of performance is used. With no feedforward control $S_{ff} = I$, and with "ideal" feedforward control $S_{ff} = 0$.

In the literature, S and S_{ff} are also denoted control ratio and feedforward control ratio, respectively (Balchen and Mummé 1988). More precisely, in Balchen and Mummé (1988), the *feedforward control ratio* is defined for single-input/single-output (SISO) controllers as

$$S_{ff} = 1 - \frac{K_{ff}}{K_{ff}^*}, \quad (9)$$

where K_{ff} is the actual feedforward controller and K_{ff}^* is the "ideal" controller for the actual process. For SISO controllers this is identical to the definition in Eq. (6). For multivariable controllers, Eq. (6) differs from the definition by Balchen and Mummé (1988, Eq. (2.10.3)), and in Eq. (7) we have introduced the sensitivity function for feedforward from the reference.

Balchen uses a Nichols chart to determine requirements on the gain and phase error in K_{ff} relative to K_{ff}^* for a given disturbance dampening (e.g. 0.1) in S_{ff} . The Nichols chart used to be convenient for the study of $h(j\omega) + 1$ given a transfer function $h(j\omega)$. With tools like Matlab, it is now easy to study any transfer function by defining a finite number of frequencies and calculate the gain or phase shift over this set of frequencies. We follow this direct approach.

4. The Effect of Model Error with Feedforward Control

In this section, we restrict ourselves to SISO processes, that is, with one control input, u , one disturbance, d ,

and one output y . With a nominal process model, $y = Gu + G_d d$, and an actual plant model $y' = G'u + G'_d d$, the actual control error is

$$e' = y' - y_r = S'(S'_{ff}G'_d d - S'_{ff,r}y_r), \quad (10)$$

where

$$S' \stackrel{\text{def}}{=} \frac{1}{1 + G'K}, \quad (11)$$

$$S'_{ff} \stackrel{\text{def}}{=} 1 - \frac{G'K_{ff}}{G'_d}, \quad (12)$$

$$S'_{ff,r} \stackrel{\text{def}}{=} 1 - G'K_{ff,r}, \quad (13)$$

S expresses the ratio between the output when a feedback controller is applied and when it is not (open loop). Similarly, S'_{ff} and $S'_{ff,r}$ express the ratio of the output when feedforward is applied and the output when it is not. This follows by comparing the output error using control in (10) with the output error when no control is applied ($u = 0$):

$$e' = y' - y_r = G'_d d - y_r. \quad (14)$$

Note that for the case with no control ($K = 0$, $K_{ff} = 0$, $K_{ff,r} = 0$), we have $S' = 1$, $S'_{ff} = 1$, $S'_{ff,r} = 1$.

The actual sensitivity can be expressed in terms of the nominal sensitivity and the relative error as following:

$$S' = S \frac{1}{1 + ET}, \quad (15)$$

where $S = 1/(1 + GK)$ and $T = 1 - S$ are the nominal sensitivity and complementary sensitivity functions, respectively, and E the relative error in G , that is, $E = G'/G - 1$ (see also Skogestad and Postlethwaite 1996, Section 5.13).

The "ideal" feedforward controller (3) gives with no model error

$$S'^*_{ff} = 0, \quad S'^*_{ff,r} = 0. \quad (16)$$

With model error we get the result

$$S'^*_{ff} = 1 - \frac{G'/G_d}{G/G_d} = -E_d, \quad (17)$$

$$S'^*_{ff,r} = 1 - \frac{G'}{G} = -E, \quad (18)$$

where E_d is the relative error in G/G_d and E the relative error in G . Thus for "ideal" controllers, S'^*_{ff} and $S'^*_{ff,r}$ are equal to (except for the sign) the relative model

errors in G/G_d and G , respectively, and we have that the "ideal" feedforward action reduces the control error for a frequency ω , as long as the relative modelling errors are less than one, that is,

$$|S_{ff}^*(j\omega)| = |E_d(j\omega)| = \left| 1 - \frac{G'(j\omega)/G'_d(j\omega)}{G(j\omega)/G_d(j\omega)} \right| < 1, \quad (19)$$

$$|S_{ff,r}^*(j\omega)| = |E(j\omega)| = \left| 1 - \frac{G'(j\omega)}{G(j\omega)} \right| < 1. \quad (20)$$

In Section 8, we discuss how to modify the ideal feedforward controller such that $|S_{ff}^*(j\omega)| < 1; \forall \omega$. However, the nominal performance becomes worse. If G is not invertible, we obtain for the feedforward controller, K_{ff}^+ in (4)

$$S'_{ff} = 1 - \frac{G'/G'_d}{G_-/G_d}, \quad (21)$$

$$S'_{ff,r} = 1 - \frac{G'}{G_-}. \quad (22)$$

For a given process and the knowledge of its uncertainty we can use (19) and (20) to see whether an "ideal" feedforward controller will be effective. This can be used to consider whether the extra controller shall be implemented, and if other control configurations or even process modifications are necessary to obtain the desired response (e.g. introduction of buffer tanks, see Fausnes and Skogestad 2003).

If the model error (uncertainty) is sufficiently large, such that the relative error in G/G_d is larger than 1, then we see from (17) that $|S_{ff}^*|$ is larger than 1 and feedforward control makes control worse. This may quite easily happen in practice. For example, if the gain in G is increased by 33% and the gain in G_d is reduced by 33%, then $S_{ff}^* = 1 - ((G'/G)/(G'_d/G_d)) = 1 - (1.33/0.67) = 1 - 2 = -1$. In words, the feedforward controller overcompensates for the disturbances, such that its negative counteractive effect is twice that of the original effect.

Another important insight from (10) and (17) is the following: To achieve $|e'| < 1$ for $|d| = 1$ with feedforward control only ($S' = 1$) we must require that the relative model error in G/G_d is less than $1/|G'_d|$. This requirement is unlikely to be satisfied at frequencies where $|G'_d|$ is much larger than 1 (see Example 1) and motivates the need for feedback control in such cases.

Example 1. Consider a plant with

$$G = \frac{300}{10s+1}; \quad G_d = \frac{100}{10s+1}. \quad (23)$$

The objective is to keep $|y| < 1$ for $d = 1$, but note that the disturbance gain at steady state is 100. Nominally, the feedforward controller $K_{ff} = G^{-1}G_d$ gives perfect control, $y = 0$. Now we apply this controller to the actual process where the gains have changed by 10%

$$G' = \frac{330}{10s+1}; \quad G'_d = \frac{90}{10s+1}. \quad (24)$$

From (10) the disturbance response in this case is

$$\begin{aligned} y' &= \left(1 - \frac{G'/G'_d}{G/G_d} \right) G'_d d \\ &= -0.22 G'_d d = -\frac{20}{10s+1} d. \end{aligned} \quad (25)$$

Thus, for a step disturbance d of magnitude 1, the output will approach -20 (much larger than 1). This means that we need to use feedback control, which is hardly affected by the above model error. There is some benefit in using feedforward control, though. The feedback control is required to be effective at all frequencies where the gain from the disturbance to the output is larger than 1. Without feedforward control the feedback loop must be effective up to $\omega_d \approx |k_d|/\tau = 100/10 = 10$. The feedforward controller brings this limit down to about $20/10 = 2$. In other words, the feedforward controller reduces the bandwidth requirement for the feedback controller from 10 to 2.

5. Some Classes of Model Uncertainty

In the following, we will consider some examples of model uncertainties for ideal feedforward controllers, and use (19) and (20) to analyse when feedforward control should be used. To simplify notation we write: $S_{ff} = S_{ff}^*$ and $S_{ff,r} = S_{ff,r}^*$.

Static gain uncertainty. Let $G' = \alpha G$ and $G'_d = \alpha_d G_d$ where α and α_d are constants. (Nominally, $\alpha = 1$ and $\alpha_d = 1$ and a +100% gain error corresponds to $\alpha = 2$ and $\alpha_d = 2$.) In this case we have from (19) that ideal feedforward control reduces the error from the disturbance, d , as long as

$$|S_{ff}| = \left| 1 - \frac{\alpha}{\alpha_d} \right| < 1 \Leftrightarrow 0 < \alpha/\alpha_d < 2 \quad (26)$$

and from (20) for the reference y_r as long as

$$|S_{ff,r}| = |1 - \alpha| < 1 \Leftrightarrow 0 < \alpha < 2. \quad (27)$$

See Fig. 2(a). In other words, if the effect of the input changes sign (which is not very common), or is

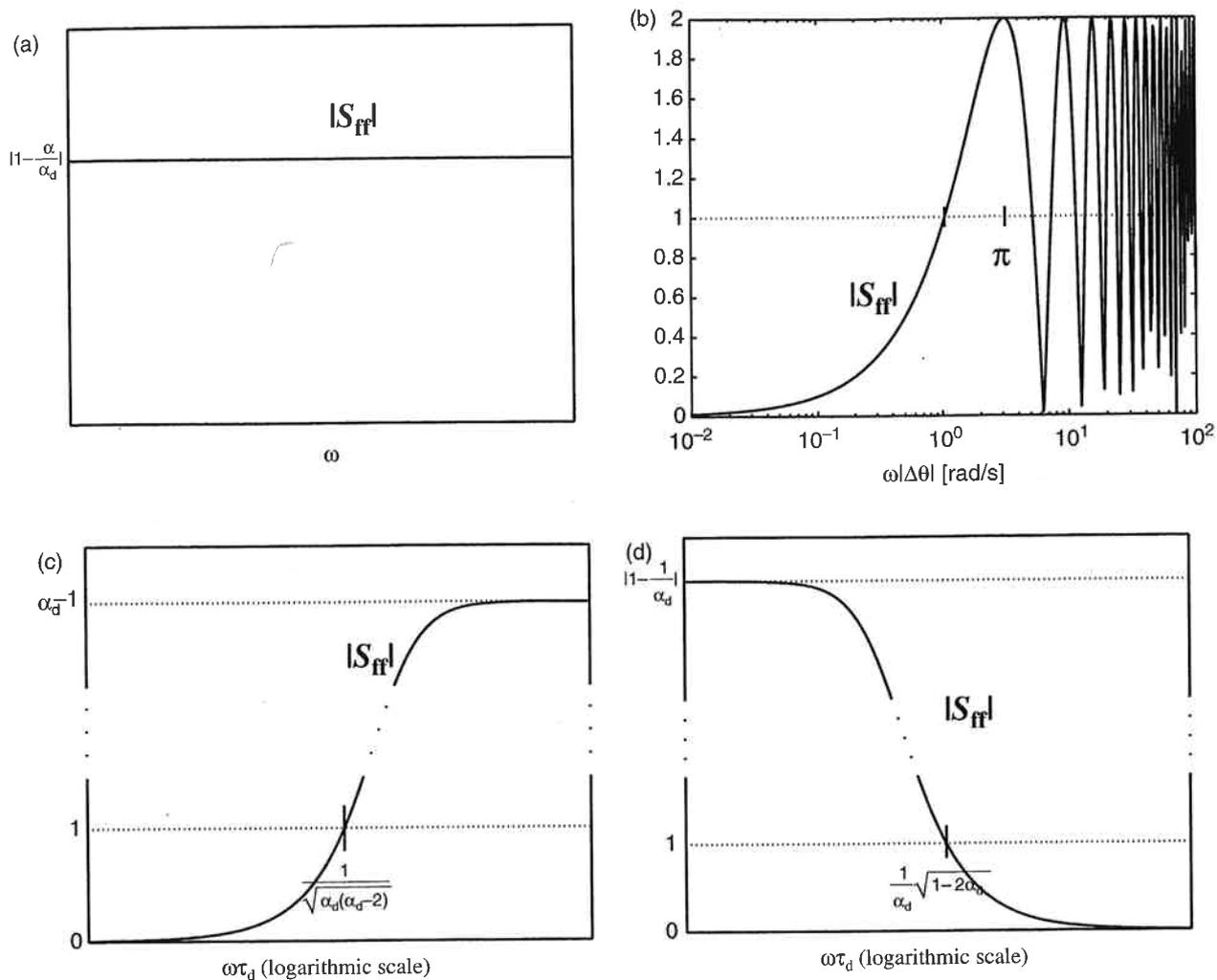

Fig. 2. Effect of uncertainty on S_{ff} for SISO feedforward control. (a) Effect of gain uncertainty $|S_{ff}| = |1 - (\alpha/\alpha_d)|$ corresponding to $G' = \alpha G$ and $G'_d = \alpha_d G_d$. (b) Effect of time delay uncertainty $|S_{ff}| = |1 - e^{\Delta\theta j\omega}|$ where $\Delta\theta = (\theta'_d - \theta') - (\theta_d - \theta)$, and $\theta'_d, \theta', \theta_d$ and θ are the delays in G'_d, G', G_d and G , respectively. At low frequencies the effect is zero, but for high frequencies, it doubles the worst-case error. (c) Effect of time constant uncertainty $|S_{ff}| = |1 - ((\alpha_d \tau_d s + 1)/(\tau_d s + 1))|$ corresponding to $G' = G$, $G_d = G_{d0}/(\tau_d s + 1)$, $G'_d = G_{d0}/(\alpha_d \tau_d s + 1)$. (d) Effect of combined uncertainty in gain and time constant $|S_{ff}| = |(1 - (1/\alpha_d))(1/(\tau_d s + 1))|$ corresponding to $G' = G$, $G_d = G_{d0}/(\tau_d s + 1)$, $G'_d = \alpha_d G_{d0}/(\alpha_d \tau_d s + 1)$.

increased by more than 100% (which may easily happen), feedforward actually makes the response worse. This will also happen, as we saw above, if the gain in G is increased by more than 33% and the gain in G_d at the same time is reduced with more than 33%, since $\alpha/\alpha_d = 1.33/0.67 = 2.0$.

In the following we will only consider feedforward from the disturbance, d .

Delay uncertainty. We let $\theta, \theta', \theta_d$ and θ'_d denote the delays for G, G', G_d and G'_d , respectively. We assume $\theta_d > \theta$, so that ideal feedforward control is feasible, and perfect models except for the delay. Now the

feedforward sensitivity becomes

$$|S_{ff}(s)| = |E_d(s)| = \left| 1 - \frac{e^{-\theta's}/e^{-\theta'_d s}}{e^{-\theta s}/e^{-\theta_d s}} \right| = |1 - e^{\Delta\theta j\omega}|, \quad (28)$$

where $\Delta\theta \stackrel{\text{def}}{=} (\theta'_d - \theta') - (\theta_d - \theta)$ is the error in the difference between the delays in G_d and G . The ideal feedforward control reduces the error at a frequency ω as long as

$$|S_{ff}(j\omega)| = |E_d(j\omega)| = |1 - e^{\Delta\theta j\omega}| = \sqrt{2 - 2 \cos(\Delta\theta\omega)} < 1. \quad (29)$$

We note that since $\cos(\Delta\theta\omega) = \cos(-\Delta\theta\omega)$, the relative delay uncertainty is independent of the sign of $\Delta\theta$. In Fig. 2(b), we plot $|S_{ff}|$ in (29) as a function of normalized frequency. At low frequencies feedforward control is perfect, but for frequencies above $\omega_1 = 1.05/|\Delta\theta|$ rad/s, feedforward has a negative effect, and in the worst-case (at frequency $\omega_{max} = \pi/|\Delta\theta|$) the feedforward effect doubles the error. To avoid that the feedforward controller amplifies the control error, the feedforward control signal may be low-pass filtered with a break frequency at about $1/|\Delta\theta|$ or less.

We may find the frequency, ω_1 , where $|S_{ff}| = 1$ analytically:

$$\omega_1 = \frac{\cos^{-1}(1/2)}{|\Delta\theta|} = \frac{1.05}{|\Delta\theta|} \approx \frac{1}{|\Delta\theta|}. \quad (30)$$

To find the frequency ω_{max} for the first maximum value of 2, we differentiate the expression for $|S_{ff}(j\omega)|$ with respect to the frequency

$$\begin{aligned} \frac{d}{d\omega}|S_{ff}| &= \frac{d}{d\omega} \sqrt{2 - 2\cos(\Delta\theta\omega)} \\ &= \frac{\Delta\theta \sin(\Delta\theta\omega)}{\sqrt{2 - 2\cos(\Delta\theta\omega)}} \end{aligned} \quad (31)$$

to obtain

$$\omega_{max} = \frac{\pi}{|\Delta\theta|}. \quad (32)$$

Uncertainty in time constants. In the general case this is more complicated to analyze than the gain and delay errors. We consider the situation where the error is in G_d only and is restricted to one time constant: $G_d = G_{d0}/(\tau_d s + 1)$ and $G'_d = \alpha_d G_{d0}/(\alpha_d \tau_d s + 1)$ where α_d is the relative error in the time constant. We then obtain the following limit for effective feedforward

$$|S_{ff}(s)| = |E_d(s)| = \left| 1 - \frac{\alpha_d \tau_d s + 1}{\tau_d s + 1} \right| < 1. \quad (33)$$

If $0 \leq \alpha_d \leq 2$, then $|1 - (\alpha_d \tau_d s + 1)/(\tau_d s + 1)|$ is always less than or equal to one. For $\alpha_d > 2$ the feedforward is effective as long as

$$\omega \tau_d < \frac{1}{\sqrt{\alpha_d(\alpha_d - 2)}}. \quad (34)$$

The maximum value of $|S_{ff}|$ is $\alpha_d - 1$, see Fig. 2(c). Again this can be used to find the frequency for which the feedforward controller shall be active.

The situation if there is an error in only G is similar to the case with error in only G_d .

Combined uncertainty in both gain and time constant ("pole uncertainty"). Some physical parameter

changes affect both the gain k_d and the time constant τ_d , such that their ratio k_d/τ_d remains constant. As an example, consider the following physical state-space model with a single state

$$\frac{dx}{dt} = Ax + Dd, \quad (35)$$

$$y = x + u, \quad (36)$$

where x is the state, u is the control input (manipulated variable), y is the output, and A and D are constants. Laplace transform yields

$$G_d(s) = \frac{D}{s - A} = \frac{-D/A}{(-1/A)s + 1}; \quad (37)$$

$$G(s) = 1.$$

An error in A will then influence both the gain ($k_d = -D/A$) and the time constant ($\tau_d = -1/A$), whereas $k_d/\tau_d = D$ remains unchanged.

The model in (37) can be written on the form $G_d = G_{d0}/(\tau_d s + 1)$ and $G'_d = \alpha_d G_{d0}/(\alpha_d \tau_d s + 1)$, where α_d is the relative error in the gain and the time constant (which is equal to the relative error in $1/A$). G contains no errors ($G' = G$). We then obtain the following requirement for effective feedforward control

$$|S_{ff}(s)| = |E_d(s)| = \left| \left(1 - \frac{1}{\alpha_d} \right) \frac{1}{\tau_d s + 1} \right| < 1. \quad (38)$$

The effect of model error is largest at low frequencies (below $1/\tau_d$ [rad/s]) where $|S'_{ff}(j\omega)| \approx |1 - 1/\alpha_d|$. Feedforward has a positive effect at all frequencies when $\alpha_d > 1/2$. For $\alpha_d < 1/2$, feedforward is effective at high frequencies

$$\omega \tau_d > \omega \tau_{d|S_{ff}|=1} = \frac{1}{\alpha_d} \sqrt{1 - 2\alpha_d} \quad (39)$$

as shown in Figure 2(d).

In other cases $G(s)$ and $G_d(s)$ share the same dynamics. For example, consider the physical model

$$\frac{dx}{dt} = Ax + Bu + Dd; \quad y = x \quad (40)$$

and we get

$$G_d(s) = \frac{D}{s - A}; \quad G(s) = \frac{B}{s - A}. \quad (41)$$

In this case $G/G_d = B/D$ and an error in A does not affect feedforward control and gives $S'_{ff} = 0$.

Frequency domain representation of uncertainties. In Levin and Scali (1988) and Scali et al. (1989) combinations of the above uncertainties were examined. The analytical method we have used above is not suitable for this case, and another approach is proposed. We want to find $|S_{ff}(j\omega)|_{\max}$, that is, the worst-case feedforward sensitivity for each frequency given the parametric uncertainty. Since it is impractical to find an analytical expression for $|S_{ff}(j\omega)|_{\max}$, we calculate its value for some $\omega_i \in \Omega$ where Ω is a set of frequencies in the relevant range:

$$|S_{ff}(j\omega_i)|_{\max} = \max_{r, r_d} \left| 1 - \frac{G_p(j\omega_i, r)/G_{d,p}(j\omega_i, r_d)}{G(j\omega_i)/G_d(j\omega_i)} \right|; \quad (42)$$

$$\omega_i \in \Omega,$$

where r and r_d are vectors of the parameters in G and G_d , respectively. For each parameter we have $r_{i_{\min}} \leq r_i \leq r_{i_{\max}}$. The optimization is in general non-convex, so that precautions must be taken to find the global optimum at each frequency.

Example 2. We consider the following process (Skogestad and Postlethwaite 1996, Example 7.3):

$$G'(s) = \frac{k}{\tau s + 1} e^{-\theta s}, \quad 2 \leq k, \theta, \tau \leq 3, \quad (43)$$

$$G'_d(s) = \frac{k_d}{\tau_d s + 1} e^{-\theta_d s}, \quad 2 \leq k_d, \theta_d, \tau_d \leq 3, \quad (44)$$

that is, nominally G and G_d are equal, but their parameters may vary independently between 2 and 3. Nominally

$$G'(s) = G'_d(s) = \frac{2.5}{2.5s + 1}. \quad (45)$$

We find that the ideal feedforward controller from the disturbance measurement is $K_{ff} = 1$. Solving the optimization problem (42)¹ gives $|S_{ff}(j\omega)|_{\max}$ as shown in Fig. 3. We can see that the ideal feedforward controller dampens the disturbance for frequencies below 0.3 rad/s for all combinations of the parameters.

¹The optimization problem is non-convex so we first make a uniform grid in the space spanned by the parameters and take the maximum value of $|S_{ff}(j\omega_i, r, r_d)|$ for all points. The result of this is used as initial value for the routine `fmincon` in Matlab. A Monte Carlo simulation results in lower values of $|S_{ff}(j\omega_i)|$ up to a frequency higher than 1 rad/s.

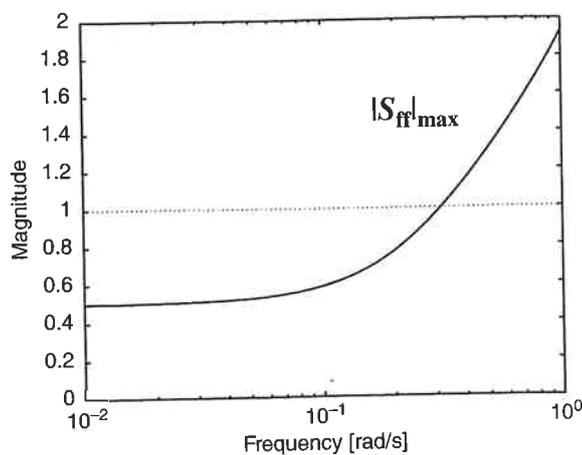

Fig. 3. $|S_{ff}(j\omega)|_{\max}$ when frequency domain uncertainty is used to represent the gain, delay and time constant uncertainties, see (43) and (44).

6. Example: Two-Tank Process

Example 3. In this example we consider feedforward control of the process illustrated in Fig. 4(a). A hot flow with flow rate q_{in} and temperature T_{in} passes through tank 1 and into tank 2 where it is cooled by mixing with a cold flow with flow rate q_c and temperature T_c . T_{in} is measured before the first tank. The outlet temperature, T_2 , shall be kept constant despite temperature variations in the hot flow. To obtain this, the measurement of T_{in} is used by a feedforward controller to adjust q_c to compensate for the variations.

In Appendix A we derive the model on transfer function form

$$y(s) = G(s)u(s) + G_d(s)d(s), \quad (46)$$

$$G(s) = \frac{k}{\tau_2 s + 1}; \quad G_d(s) = \frac{k_d}{(\tau_1 s + 1)(\tau_2 s + 1)} e^{-\theta s}, \quad (47)$$

where $d = T_{in}$ is the disturbance, $u = q_c$ is the control input and $y = T_2$ is the output that shall be kept constant. The parameters are defined by $\tau_1 = V_1^0/q_{in}^0$, $\tau_2 = V_2^0/q^0$, $k = (T_c^0 - T_2^0)/q^0$ and $k_d = q_1^0/q^0$, where $q^0 = q_1^0 + q_c^0$.

6.1. Feedforward Controller Design

The "ideal" feedforward controller is given by (3):

$$K_{ff} = G^{-1}G_d = \frac{k_d/k}{\tau_1 s + 1} e^{-\theta s}. \quad (48)$$

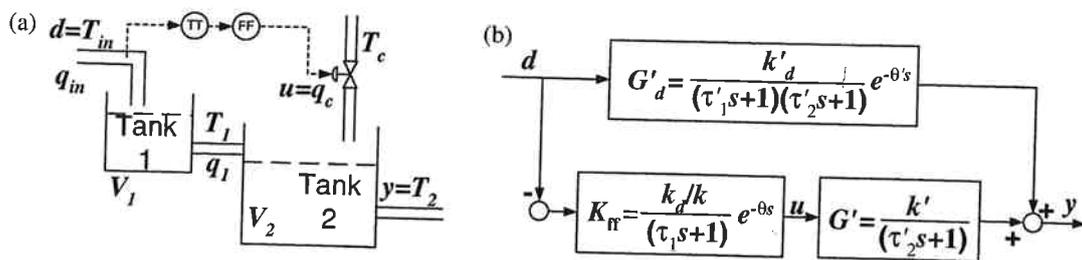

Fig. 4. The process in Example 3. (a) Illustration of the process. Nominal data: $V_1^0 = 1001$, $V_2^0 = 701$, $q_{in}^0 = q_1^0 = 161/s$, $q_c^0 = 41/s$, $T_c^0 - T_2^0 = -40^\circ C$. (b) Block diagram. Parameters derived from the nominal data: $k' = -2$, $k'_d = 0.8$, $\tau'_1 = 6.25$, $\tau'_2 = 3.5$. In addition there is a delay, $\theta' = 10s$.²

In Fig. 4(b) we have illustrated the process and the feedforward controller in a block diagram. The variables of the actual plant are marked with a prime.

6.2. Sinusoidal Disturbances

We will now see how a feedforward controller dampens the effect of sinusoidal disturbances. The disturbance has amplitude 1 and three frequencies are considered: 0.1, 1 and 2 rad/s. (These three frequencies have been chosen to illustrate $|S_{ff}(j\omega)| < 1$, $|S_{ff}(j\omega)| \approx 1$, and $|S_{ff}(j\omega)| > 1$.) We will study six cases (the results are summarized in Fig. 5):

- No control.* See Figure 5(a).
In the remaining cases we use the feedforward control in (48).
- Nominal case (perfect model).* As seen in Fig. 5(b), the disturbance is perfectly cancelled by the feedforward controller.
- Gain error* $k'_d = 0.5k_d$, and no error in G . Figure 5(c) illustrates that the feedforward controller does not help, that is, the feedforward controller overcompensates such that the variation in y has the same amplitude as without control, as expected from (26). This applies to all frequencies. If the gain error is reduced, the feedforward controller has a positive effect on the dampening compared to no control, whereas if the gain error increases further above 2, the feedforward controller has a negative effect.
- Delay error* $\theta'_d = \theta_d - 1$; $\theta' = \theta \Rightarrow |\Delta\theta| = 1$, which is 10% of the delay (see Fig. 5(d)). From (30) the feedforward controller has a dampening effect up to the frequency $1/|\Delta\theta| = 1$ rad/s, as confirmed by the simulation results. Even this relative small

error gives a low frequency limit for where the feedforward controller is effective.

- Error in time constant* $\tau'_1 = 3\tau_1$. This may be the result of operating tank 1 with a higher level than expected in the model. In Section 4, we found that for all frequencies, the feedforward controller has a positive effect on the dampening as long as $\tau'_1 < 2\tau_1$. When the error is larger than this than this, as it is here, feedforward control is effective (by (34)) for frequencies $\omega < 1/((6.25/3)\sqrt{3(3-2)}) = 0.277$. As illustrated in Fig. 5(e) at 0.1 rad/s, the controller has some dampening effect, while above this frequency the controller makes the situation worse.
- Error in gain and time constant* $k'_d = 0.5k_d$ and $\tau'_1 = 0.5\tau_1$, see Fig. 5(f). At low frequencies the response is similar to a pure gain error, but this error gives no problems for high frequency disturbances.

6.3. Step Disturbances

Using the same controller, the output response (y) to a unit step in the disturbance (d) is shown in Fig. 6.

- Gain errors* give problems at low frequencies, and therefore we get an offset from set-point after a step disturbance (see Fig. 6(a)). With pure feedforward this is clearly the worst error for "step like" disturbances.
- Delay errors* give problems only at high frequencies (Fig. 6(b)), so that the deviation from set-point has a limited duration. The performance is improved compared to no control.
- Time constant errors* give only transient deviations from the set-point (see Fig. 6(c)).
- Combined gain and time constant errors* (Fig. 6(d)) give the same steady-state response as the gain error. But the error is smaller in the beginning, which makes it easier for feedback control.

²Actually in Example 3 we consider errors in the nominal model (G, G_d), and thereby in the controller K_{ff} , while the actual plant (G', G'_d) is kept constant. This has the advantage that the response without control remains constant, so that it is easier to identify the effect on performance of using an incorrect model in the controller.

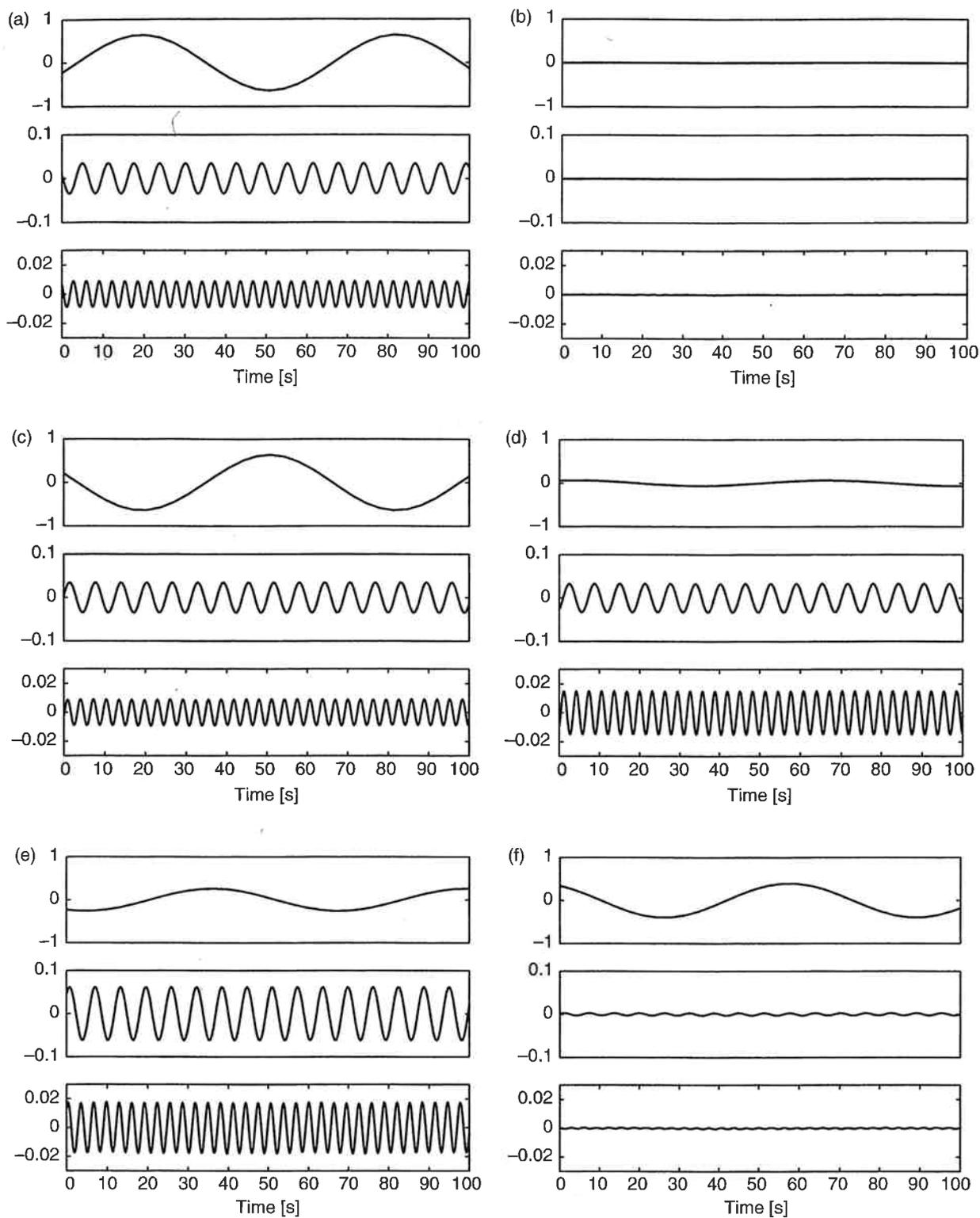

Fig. 5. Feedforward control of two-tank process: Response ($y = T_2$) to sinusoidal disturbances ($d = T_{in} = \sin \omega t$ with frequencies 0.1, 1 and 2 rad/s (upper, middle and lower plot, respectively)). (a) No control. (b) Nominal case: Perfect control. (c) Gain error ($k'_d = 0.5k_d$): Same amplitude as with no control (for all frequencies). (d) Delay error ($|\Delta\theta| = 1$): Improved performance for 0.1 rad/s, no effect for 1 rad/s, and larger amplitude for 2 rad/s. (e) Error in time constant ($\tau'_1 = 3\tau_1$): Improved performance only for the lowest frequency. (f) Error in gain and time constant ($k'_d = 0.5k_d$ and $\tau'_1 = 0.5\tau_1$): Improved performance for the two highest frequencies.

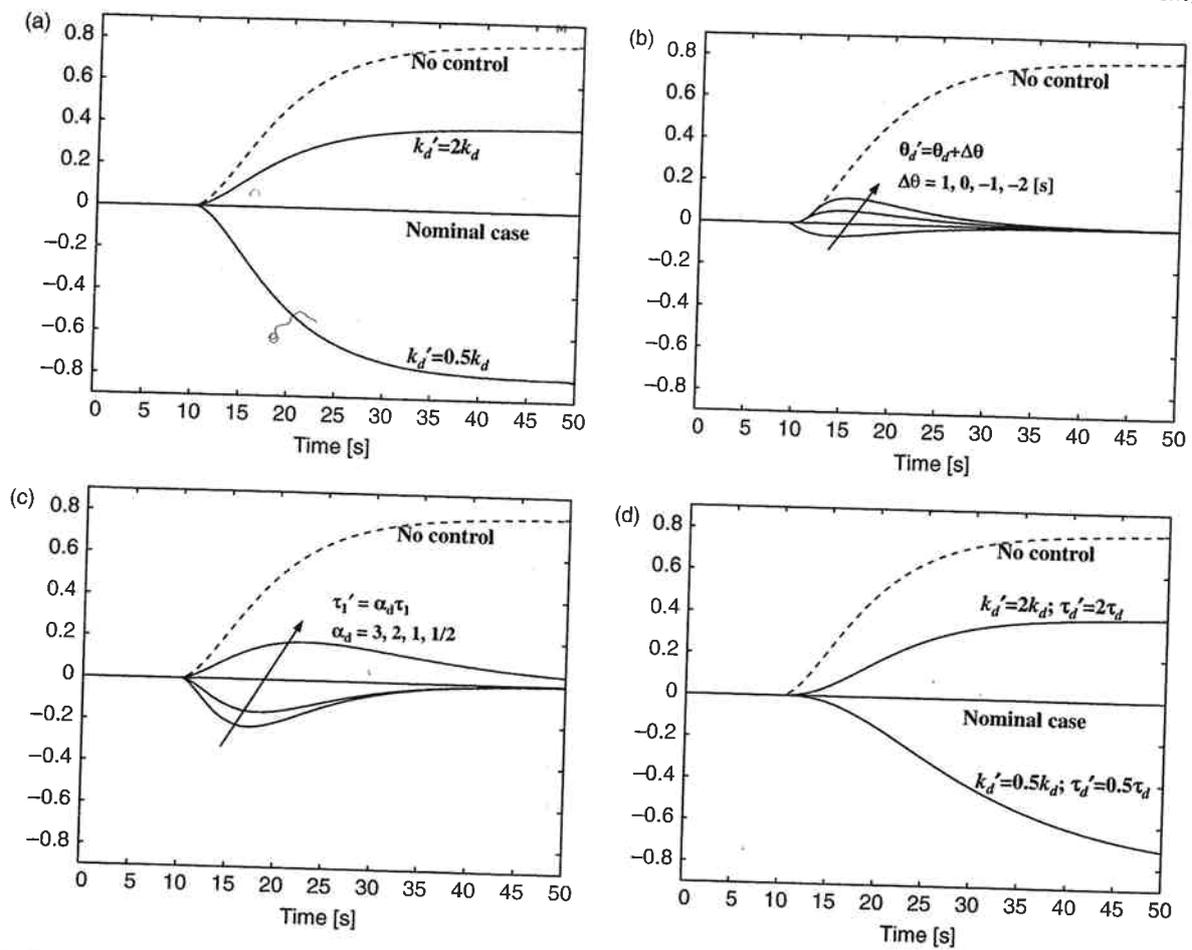

Fig. 6. Feedforward control of two-tank process: Response ($y = T_2$) to unit step disturbances ($d = T_{in}$). (a) Gain errors. (b) Delay errors. (c) Errors in time constant. (d) Errors in gain and time constant.

7. When is Feedforward Control Needed and When is it Useful?

We will now shortly discuss when a feedforward controller is needed and useful in the combination with a feedback controller. We consider a scalar system and assume that the variables are scaled, so that the disturbance d is within ± 1 , and the control error, $e' = y' - y_r$, shall stay within ± 1 . We consider two cases (similar to the buffer tank design; Faanes and Skogestad 2003):

Given feedback controller (known S). Given the sensitivity function $S(j\omega)$ and a transfer function from the disturbance to the output of $G_d(j\omega)$. Then feedforward is needed (with $|S_{ff}(j\omega)| < 1$) at all frequencies where

$$|S(j\omega)G_d(j\omega)| > 1. \quad (49)$$

Unknown S (shortcut method)

1. Let ω_d denote the frequency up to which $|G_d(j\omega)| > 1$, such that control is needed to achieve acceptable disturbance rejection.
2. Let ω_B denote the frequency up to which feedback control is effective, i.e., $|S(j\omega)| < 1$ for all $\omega < \omega_B$. Approximations of the achievable ω_B for a given process are discussed in (Skogestad and Postlethwaite 1996, pp. 173–174) and (Faanes and Skogestad 2003).

It then follows that feedforward control is needed (with $|S_{ff}(j\omega)| < 1$) in the frequency range from ω_B to ω_d .

A similar rule is given by Middleton and Goodwin (1990), although they denote ω_d the *desired bandwidth* with no reference to how to determine this.

Feedforward control may also be needed outside the range between ω_B and ω_d , namely when $|S| > 1/|G_d|$. But at least we know that if $\omega_B < \omega_d$,

then feedforward control (or some process or instrumentation modification) is needed.

Knowing where feedforward control is needed, we may use $|S'_{ff}(j\omega)|$ to identify where a given feedforward controller is useful. This is illustrated in Fig. 7. In Fig. 7(a), the model error is so large that feedforward control has a negative effect on the performance for frequencies between ω_B and ω_d . In Fig. 7(b), feedforward control reduces the control error for some frequencies, while at others it makes the performance worse ($|S'_{ff}(j\omega)| > 1$). In Fig. 7(c), feedforward control is effective in the whole range between ω_B and ω_d .

Example 3. (continued from Section 6). Is the feedforward controller needed and useful? Figure 7 demonstrates that the feedforward controller must be effective for the frequencies where the feedback loop

fails to dampen disturbances. We will here check if our feedforward controller is useful when there is a delay error in the feedforward loop of $\Delta\theta = 1$ s.

We apply feedback control using a measurement of T_2 . Because of the delay and the higher-order dynamics in tank 2, the bandwidth of this control loop is limited. We consider two different effective delays in the feedback loop: Case (a) $\theta_2 = 0.62$ s and Case (b) $\theta_2 = 10$ s.

The process model is scaled assuming that the outlet temperature is allowed to vary $\pm 0.05^\circ\text{C}$ around the nominal value, and obtain a modified $\tilde{k}_d = k_d/0.05 = 16.0$. A PI controller with $k_c = 0.5\tau_2/(k\theta)$ and $\tau_I = \min(\tau_2, 8\theta) = \tau_2$ (SIMC tuning, see Skogestad 2003) is used.

Now $S(j\omega)$ is known, and thereby SG_d . For both cases (a) and (b) there is a frequency range where

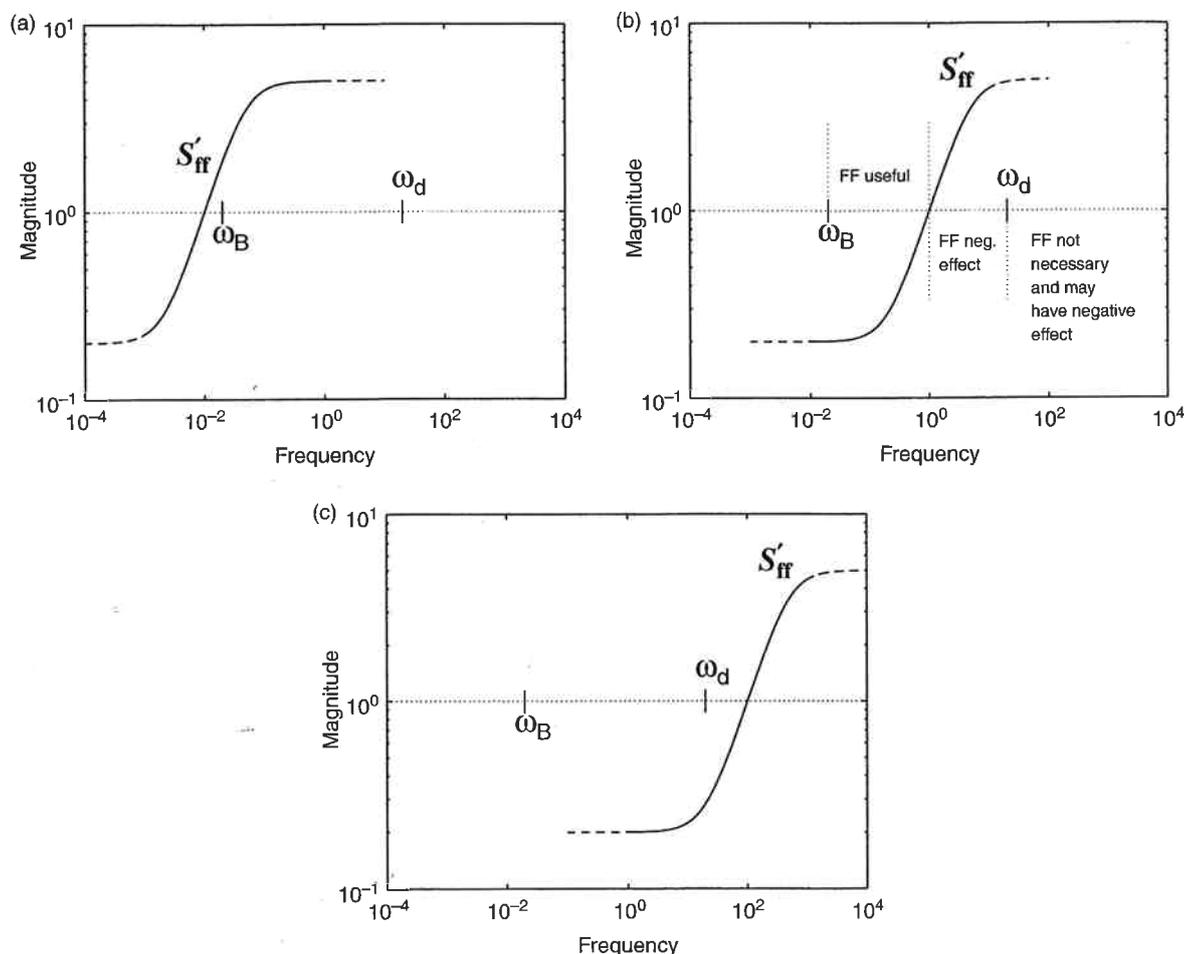

Fig. 7. Examples of (a) large, (b) intermediate and (c) small relative model errors, $S'_{ff} = -E_d$. ω_B is the bandwidth for feedback control, and ω_d is the required disturbance bandwidth. More generally, feedforward control is required at frequencies where $|SG_d| > 1$. (a) Feedforward has a negative effect. (b) Feedforward is useful at low frequencies, but has a negative effect at high frequencies. (c) Feedforward is useful for all frequencies between ω_B and ω_d .

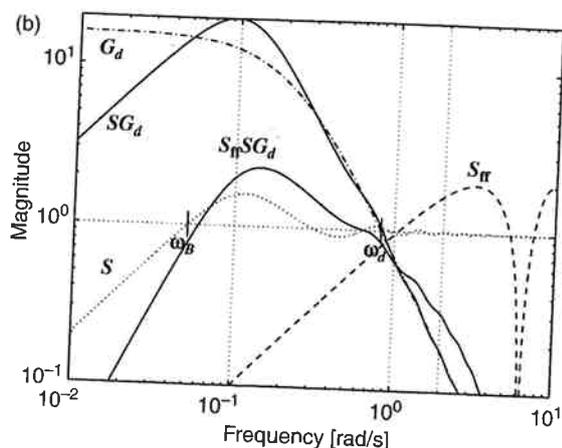
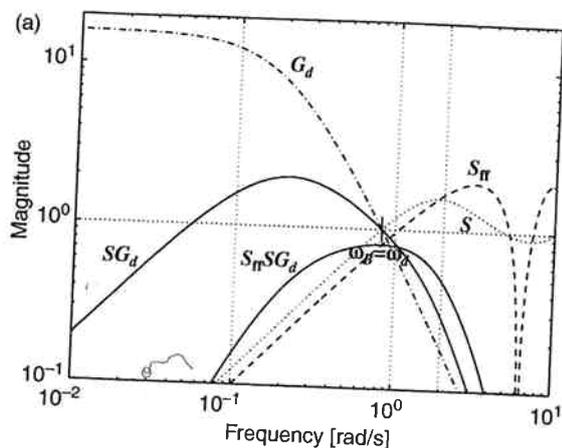

Fig. 8. Example 3: Combination of feedback and feedforward control illustrated in the frequency domain. Delay error, $|\Delta\theta| = 1$ s. (a) Delay of 0.62 s in tank 2: $\omega_B = \omega_d$. (b) Delay of 10 s in tank 2: $\omega_B < \omega_d$.

$|SG_d| > 1$ (see Fig. 8). For both cases, $|S_{ff}| < 1$; $\forall \omega < \omega_d$, so feedforward control is clearly useful.

For case (a) the combination of feedforward and feedback gives acceptable performance with $|S_{ff}(j\omega)S(j\omega)G_d(j\omega)| < 1$; $\forall \omega$. However, for case (b) this is not the case, and we have an intermediate frequency range where $|S_{ff}SG_d| > 1$.

We note from Fig. 8(a) that feedforward control is needed even though $\omega_B = \omega_d$. The reason is that G_d has slope -2 whereas S has slope 1 in the logarithmic scale.

In conclusion, we see that for a delay error of $\Delta\theta = 1$ s in the feedforward loop, the addition of feedforward control is useful both with the short ($\theta_2 = 0.62$ s) and long delay ($\theta_2 = 10$ s) in the feedback loop. For the longest delay (10 s), additional improvements (design changes) are necessary in order to achieve the performance requirements.

8. Design of Feedforward Controllers under Uncertainty

Knowledge of the model uncertainty may be utilized in the feedforward controller design. \mathcal{H}_2 optimal combined feedforward/feedback control under the presence of uncertainty is derived in (Lewin and Scali 1988, Scali et al. 1989). Here, we discuss two other methods:

- Two step procedure: (1) Choose a nominal model and design the ideal feedforward controller. (2) Modify this by introducing a low-pass filter or by reducing the gain to achieve $|S_{ff}(j\omega)| < 1$; $\forall \omega$.
- μ -optimal feedforward controller.

8.1. Modification of Ideal Feedforward Controller

Errors in time constants or time delays lead to reduced performance at high frequencies, and one may attempt to avoid this by adding a low-pass filter in series with the feedforward controller. The break frequency can be chosen as the frequency where $|S_{ff}(j\omega)|$ crosses 1. For delay error $\Delta\theta$ the break frequency is about $1/\Delta\theta$, and for a relative error α_d in the time constant in G_d , τ_d , the break frequency is about $1/(\tau_d\sqrt{\alpha_d(\alpha_d - 2)})$ (see Section 5 for details).

Low-pass filters are also often used to remove noise from the measurement to avoid excessive wear in the actuators (e.g. Buckley 1964).

Gain errors reduce the performance at all frequencies, so a low-pass filter does not help. The only way to avoid the feedforward controller from making the situation worse is to reduce the gain of the feedforward controller so that $|S_{ff}(j\omega)| < 1$ for the whole range of the process gains. This will, however, reduce the effect of the feedforward controller in the nominal case. If we choose $K_{ff} = \beta K_{ff}^*$ (where K_{ff}^* is the ideal controller obtained with the nominal model), we obtain

$$S_{ff} = 1 - \beta \frac{\alpha}{\alpha_d}, \quad (50)$$

where α and α_d are the gain errors in G and G_d , respectively. To assure $|S_{ff}| < 1$, we take the smallest possible α_d , and the largest possible α and choose the following reduction factor, β :

$$\beta = 2 \frac{\min(\alpha_d)}{\max(\alpha)}. \quad (51)$$

We have here assumed $\alpha/\alpha_d > 0$. β will always be less than 1 since we only make use of it as long as $\max(\alpha)/\min(\alpha_d) > 2$.

8.2. μ -optimal Feedforward Design

Normally, μ -design is used for feedback controllers (Doyle 1982, 1983, Skogestad and Postlethwaite 1996), but may also be applied to feedforward controllers. In this case, the whole design is taken in one step (and not by modifications on a nominal design). Figure 9 illustrates how the problem may be formulated for the feedforward case. The μ -design algorithm finds the controller (between the disturbance, d , and G) that minimizes the weighted output, that is, the output of W_p . The uncertainty block Δ may be structured so that the uncertainty in G and G_d may be independent.

With the presently available software we cannot handle delays in the μ -design. If one knows that nominally the feedforward controller should include a delay, this may be included manually after the

μ -design. The nominal delays in G and G_d are then omitted in the models used for the μ -design.

We will now apply the two methods to the example in Section 6.

Example 3. (continued from Section 6) *Low-pass filter.* We consider $\theta'_d = \theta_d - 1$ s, and add to the ideal feedforward controller a first-order low-pass filter with break frequency $1/|\Delta\theta| = 1$ rad/s.

From Fig. 10(a), we see that the filtered feedforward controller makes the nominal performance worse, especially at high frequencies where it approaches no control (compare with Fig. 5(a) and (b)). On the other hand, with delay error (Fig. 10(b)) the performance is slightly improved (compare with Fig. 5(d)) at the highest (worst) frequency, but at lower frequencies the performance remains poorer with the filter. These results are confirmed in Fig. 11, which shows the magnitude at all frequencies.

The filter introduces a phase shift, and therefore a delay error of 1 s no longer gives the same effect as -1 s, and in the opposite direction the effect of the filter is better.

μ -design. We consider combined gain and delay error in G , and design a μ -optimal feedforward controller using the setup in Fig. 9. We let the uncertainty weight, W_I , be diagonal with elements

$$W_{I1} = 10^{-4}, \quad (52)$$

$$W_{I2} = \frac{1.1s + 0.2}{0.5s + 1} \frac{(1/2.363)^2 s^2 + 2 \cdot 0.838 \cdot (1/2.363)s + 1}{(1/2.363)^2 s^2 + 2 \cdot 0.685 \cdot (1/2.363)s + 1}, \quad (53)$$

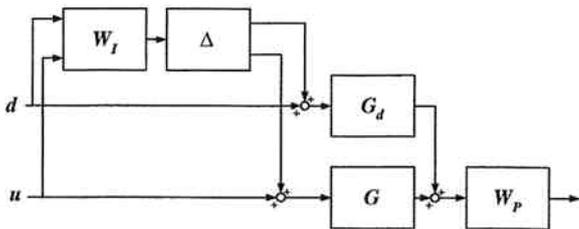

Fig. 9. Problem formulation for the design of a μ -optimal feedforward controller.

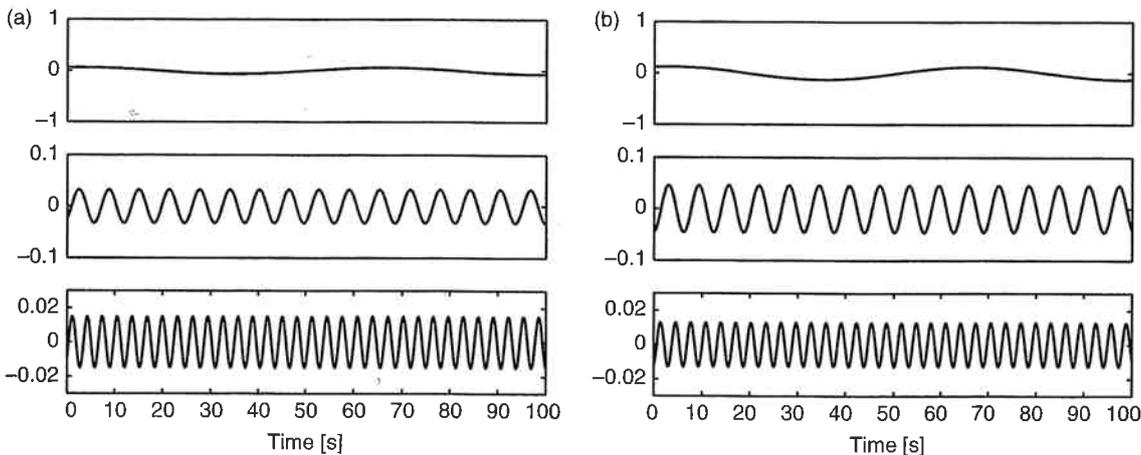

Fig. 10. Feedforward controller with low-pass filter (response of sinusoidal disturbances with amplitude 1 and frequencies 0.1, 1 and 2 rad/s on the process of Example 3). (a) Nominal case: The feedforward effect is reduced or removed by the filter. (b) Delay error ($\theta'_d = \theta_d - 1$ s): With the filter the feedforward controller does not make the performance worse for any of these three frequencies.

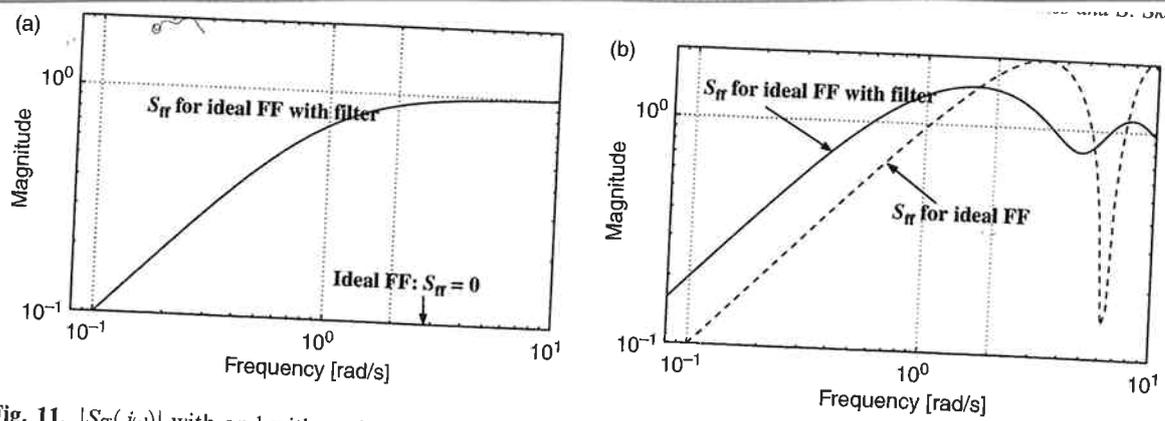

Fig. 11. $|S_{II}(j\omega)|$ with and without low-pass filter (Example 3). (a) Nominal case. (b) Delay error ($\theta'_d = \theta_d - 1$ s).

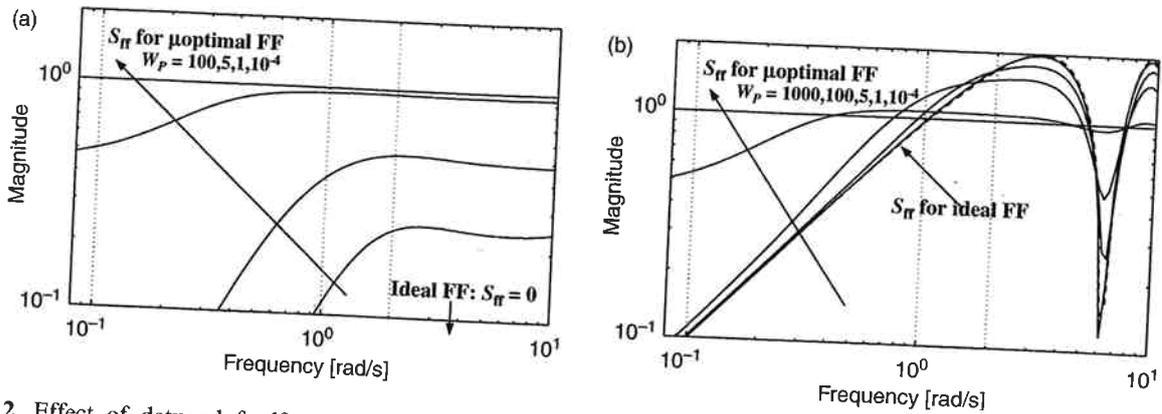

Fig. 12. Effect of detuned feedforward control: $|S_{II}|$ for μ -optimal feedforward controllers with performance weight, $W_p = 1000, 100, 5, 1, 10^{-4}$. ($|S_{II}|$ for the ideal controller (48) is dashed.) (a) Nominal case (no uncertainty). (b) Delay error ($\theta'_d = \theta_d - 1$ s).

where W_{I_1} represents the uncertainty in G_d (approximately zero) and W_{I_2} represents the uncertainty in G corresponding to 20% gain uncertainty and ± 1 s delay uncertainty (Skogestad and Postlethwaite 1996, Eq. (7.27)). The performance weight, W_p , is chosen as a constant independent of frequency, and several values for W_p is considered (from 10^{-4} to 1000). A large value of W_p corresponds to requiring tight control. The μ -controller is designed with D-K iterations using the μ -toolbox in Matlab (with scaling matrices of order 2). The delay difference between G and G_d is removed from the models used for the design, and the nominal delay of 10 s is included manually in the feedforward controller.

The resulting $|S_{II}|$ is seen in Fig. 12. From the peak value in Fig. 12(b), we see that with W_p large the μ -optimal feedforward control is close to the "ideal" controller in (48). "Detuning" ($W_p < \infty$) gives little improvement when there is a delay error, except when a large detuning ($W_p \leq 1$) is used. However, nominal performance is then poor. This is confirmed by Fig. 13, which shows the step response with gain

and delay errors (only errors in the direction that gives benefit are shown).

In summary, with a low weight on performance (small W_p), the μ -optimal feedforward controller approaches no control ($|S_{II}| = 1; \forall \omega$). Interestingly, with a large weight on performance (large W_p) we obtain a feedforward controller close to the ideal.

9. Conclusions

In this paper, we have discussed and illuminated some important characteristics of feedforward controllers. We have defined the feedforward "sensitivity functions", S'_{II} and $S'_{II,r}$ for the disturbance and the reference, respectively. For ideal feedforward controllers, $K_{II}^* = G^{-1}G_d$ and $K'_{II,r} = G^{-1}$, we find that S'_{II}^* is equal to the relative error in G/G_d , and $S'_{II,r}^*$ is equal to the relative error in G (except for the signs). A simple frequency domain analysis of $|S_{II}|$ and $|S_{II,r}|$ shows for which frequencies feedforward control has a positive (dampening) effect when certain uncertainties

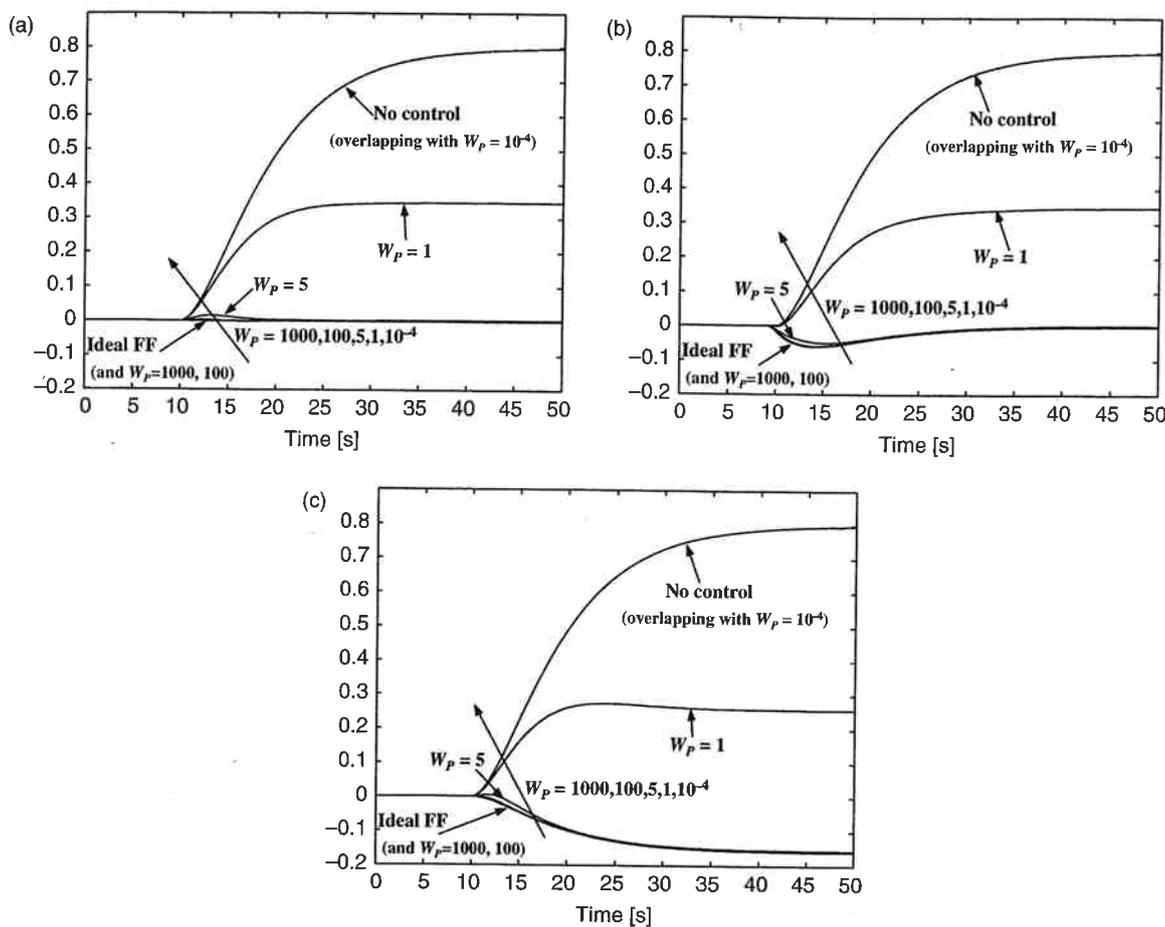

Fig. 13. Effect of detuned feedforward control: Step responses for μ -optimal feedforward controllers with performance weight, $W_p = 1000, 100, 5, 1, 10^{-4}$. (a) No delay error. (b) 20% gain error. (c) Delay error: $\theta'_d = \theta_d + 1$ s.

are present (in gain, delay, dominant time constant and a common combination of gain and time constant). The results are summarized in Fig. 2. We also discuss how to analyze the effect of more complex uncertainties.

Feedforward is needed when the bandwidth, ω_B , of the feedback controller is below the frequency ω_d for which $|G_d|$ becomes less than one (with appropriate scaling). We must then require $|S_{ff}(j\omega)| < 1$ in the frequency region between ω_B and ω_d , or if it is known, for all frequencies where the closed loop frequency response, $|S(j\omega)G_d(j\omega)|$, is above 1. See Fig. 7 for a summary.

The ideas are illustrated with a process example.

Acknowledgements

Financial support from The Research Council of Norway (NFR) and the first author's previous employer Norsk Hydro ASA is gratefully acknowledged. The

authors also wish to thank Asst. Prof. Torsten Wik, Chalmers University of Technology, Sweden, for useful comments.

References

- Balchen JG. Reguleringssteknikk Bind 1 (In Norwegian) 1. Tapir, Trondheim, Norway, 1968
- Balchen JG, Mummé KI. Process Control. Structures and Applications. Van Nostrand Reinhold, New York, 1988
- Buckley PS. Techniques of Process Control. John Wiley & Sons, Inc., New York, 1964
- Coughanowr DR. Process Systems Analysis and Control. McGraw-Hill Inc., New York, 1991
- Doebelin EO. Control System Principles and Design. John Wiley & Sons, New York, 1985
- Doyle J. Analysis of feedback systems with structured uncertainties. IEEE Proc Part D 1982; 129(6): 242-250
- Doyle JC. Synthesis of robust controllers and filters. Proc. IEEE Conf. on Decision and Control, San Antonio, Texas, 1983, pp 109-114

- Faanes A, Skogestad S. Buffer tank design for acceptable control performance. *Ind Eng Chem Res* 2003; 42(10): 2198–2208
- Harriott P. *Process Control*. McGraw-Hill, New York, 1964
- Holt BR, Morari M. Design of resilient processing plants – V. The effect of deadtime on dynamic resilience. *Chem Eng Sci* 1985a; 40(7): 1229–1237
- Holt BR, Morari M. Design of resilient processing plants – VI. The effect of right-half-plane zeroes on dynamic resilience. *Chem Eng Sci* 1985b; 40(1): 59–74
- Lewin DR, Scali C. Feedforward control in presence of uncertainty. *Ind Eng Chem Res* 1988; 27: 2323–2331
- Marlin TE. *Process Control. Designing Processes and Control Systems for Dynamic Performance*, McGraw-Hill, Inc., New York, 1995
- Middleton RH, Goodwin GC. *Digital Control and Estimation*. Prentice-Hall International, London, 1990
- Morari M, Zafiriou E. *Robust Process Control*. Prentice Hall, Englewood Cliffs, NJ, USA, 1989
- Ogata K. *Modern Control Engineering*. Prentice-Hall, Inc., Englewood Cliffs, NJ, USA, 1996
- Scali C, Hvala M, Lewin DR. Robustness issues in feedforward control. ACC-89 1989, pp 577–581
- Seborg D, Edgar TF, Mellichamp DA. *Process Dynamics and Control*. John Wiley & Sons, New York, 1989
- Shinskey FG. *Process Control Systems – Application, Design, and Tuning*, 4th edn. McGraw-Hill Inc., New York, 1996
- Skogestad S. Simple analytic rules for model reduction and PID controller tuning. *J Proc Control* 2003; 13(4): 291–309
- Skogestad S, Postlethwaite I. *Multivariable Feedback Control*. John Wiley & Sons, Chichester, New York, 1996
- Stephanopoulos G. *Chemical Process Control: An Introduction to Theory and Practice*. Prentice-Hall International, Englewood Cliffs, NJ, USA, 1984
- Zhou K, Doyle JC, Glover K. *Robust and Optimal Control*. Prentice Hall, Englewood Cliffs, NJ, USA, 1996

Appendix A: Modelling of the Two-Tank Process

We here develop a model of the two-tank process of Example 3. Energy balances for tanks 1 and 2 can be expressed by

$$\frac{d(c\rho V_1 T_1)}{dt} = c\rho q_{in} T_{in} - c\rho q_1 T_1, \quad (54)$$

$$\frac{d(c\rho V_2 T_2)}{dt} = c\rho q_1 T_1 + c\rho q_c T_c - c\rho q_2 T_2, \quad (55)$$

where T_1 and T_2 are the temperatures in the two tanks, c is the heat capacity, ρ the density (c and ρ are both assumed constant and temperature independent), V_1 and V_2 are the volumes of tank 1 and 2, respectively, and q_1 and q_2 are the outlet flow rates from the two tanks. By use of the mass balance for both tanks, the energy balance simplifies to

$$\frac{dT_1}{dt} = \frac{q_{in}}{V_1} (T_{in} - T_1), \quad (56)$$

$$\frac{dT_2}{dt} = \frac{q_1}{V_2} (T_1 - T_2) + \frac{q_c}{V_2} (T_c - T_2). \quad (57)$$

Linearization around a steady-state nominal point (marked with 0) under the assumption that q_{in} , q_1 and T_c are constant, yields

$$\frac{d\Delta T_1}{dt} = \frac{q_{in}^0}{V_1^0} \Delta T_{in} - \frac{q_{in}^0}{V_1^0} \Delta T_1, \quad (58)$$

$$\frac{d\Delta T_2}{dt} = \frac{q_1^0}{V_2^0} \Delta T_1 - \frac{q_1^0}{V_2^0} \Delta T_2 + \frac{T_c^0 - T_2^0}{V_2^0} \Delta q_c, \quad (59)$$

where $q^0 = q_1^0 + q_c^0$. The terms with ΔV_1 and ΔV_2 are cancelled since $T_{in}^0 = T_1^0$ and in tank 2 steady-state energy balance yields $q_1^0 T_1^0 + q_c^0 T_c^0 = (q_1^0 + q_c^0) T_2^0$. Laplace transform yields for the outlet temperature

$$T_2(s) = \frac{q_1^0/q^0}{(V_1^0/q_{in}^0 s + 1)(V_2^0/q^0 s + 1)} T_{in}(s) + \frac{(T_c^0 - T_2^0)/q^0}{V_2^0/q^0 s + 1} q_c(s). \quad (60)$$

In (60), some delay and higher-order dynamics in tank 1, that is, between the measurement of T_{in} and the inlet of tank 2, is ignored. This is represented by a delay, θ . Delay and higher order dynamics in tank 2 can be ignored since they can be assumed equal for the disturbance and the control input. We obtain the model (46) and (47).