

A Systemic Mock Circulation for In-Vitro Testing of a Pneumatically Operated Left Ventricular Assist Device

A. Karabegovic* M. Hinteregger* C. Janeczek* W. Reichenfeller* V. Soragnese **
W. Mohl** M. Gföhler*

*Institute for Engineering Design and Logistics Engineering, Vienna University of Technology,
Vienna, 1060 Austria (Tel: +43-1-58801-30764; e-mail: alen.karabegovic@tuwien.ac.at)

**Department of Cardiac Surgery, Medical University of Vienna,
Vienna, 1090 Austria (e-mail: werner.mohl@meduniwien.ac.at)

Abstract: This work presents the development of a systemic mock circulation loop designed for testing of an axial flow, pneumatically operated left ventricular assist device (LVAD). A simulation of the heart proximal systemic circulation has been implemented that resembles the environment in which the LVAD will be operating, from where a hydraulic system, with several reconsiderations, has been constructed. An alternative method for measurement of the pulsatile aortic flow is suggested. A significant match between the simulated and measured system responses is demonstrated which substantially simplifies the search for parameter sets that determine the hemodynamic behavior of the system. Due to a high degree of flexibility and a wide range of hemodynamic states that can be simulated, the presented mock circulation is suitable for in-vitro experiments with the LVAD.

Keywords: Mock circulation loop (MCL), Left ventricular assist device (LVAD), Developments in measurement, Physiological model, Medical applications

1. INTRODUCTION

Acceleration of the recovery process and increase of chances for a successful recovery in a bridge-to-recovery therapy of a failing heart remain among the most important topics in modern cardiology [Brooker 2012]. To investigate further therapeutic options using mechanical assist devices, the project 'Assistocor' has been started. It is focused on developing an innovative, pneumatically operated miniature left ventricular assist device (LVAD) which will be used during short-term post-surgical recovery of the patient. The device is designed for insertion between the pathological left ventricle (LV) and the aorta, thereby assisting a failing heart in delivering the blood from the LV into the circulatory system.

1.1. Testing of ventricular assist devices

Before the human trials can be started, heart pumps need to be extensively tested. Several testing procedures exist for that purpose [Reul 1992]. First is the determination of the pump's characteristics in a non-pulsatile test stand that simulates static pressure differences at predefined flows which are not physiological in nature. The same concept is usually applied for hemolysis tests.

The extension to that are pulsatile in-vitro tests, where the short-term dynamics of the LVAD is verified, the purpose being the testing of the materials and overall pump design in a reproducible environment [Spurlock et al. 2012]. Reproducibility of hemodynamic states enables direct comparison of different design evolutions of circulatory

supports, which helps guiding the later development in the necessary direction.

In-vivo trials on animals are the final method that helps in understanding the therapeutic effects and possibly highlights shortcomings of the developed pump that need to be solved before the start of first patient applications.

1.2. Mock circulatory loops - state of the art

The construction of in-vitro test stands is usually tightly bound to the application of the tested heart pumps and can be done with different levels of complexity. This resulted in the existence of a significant number of various mock circulatory loops designed for individual needs of tested devices. However, one can usually divide them into two main groups, depending on the means of controlling the parameters defining their behaviour: purely hydraulic and hybrid, hardware in the loop (HIL) circulations [Ferrari et al. 2005].

Hydraulic mock circulations are modelled to resemble the real human circulation by implementing a single actuating element simulating the myocardium, with the pressure and flow curves being indirectly adjusted using hydraulic, mostly passive elements [Timms et al. 2005]. The benefit of this method is its accuracy in observing the influence of the ventricular assist devices on the flow shaping in their proximity and in the rest of the circulation. In case of LVADs the aortic flow characteristics are usually of interest. Biggest disadvantage of this method is its large complexity due to intercoupled hydraulic elements. This can lead to a time-consuming parameter search for each pathology that needs to be simulated if no satisfactory computer simulation of the system exists.

Hybrid mock circulations are based on interfacing the numerical model of the circulation with the hydraulic test stand, thereby mimicking the pressures and flows found at a predefined position in the real circulation. Main benefit comes from the ability to more directly simulate the circulation to a higher level of complexity using an electrical-hydraulic interface [Kozarski et al. 2003]. The main disadvantage is that each circulatory phenomenon needs to be actively simulated, as well as rather high costs of such systems.

1.3. Presented mock circulation

This work presents a hydraulic, systemic mock circulation designed for determining the dynamic pressure-flow characteristics of a pneumatically operated LVAD. The main requirement was to artificially create the environment that the heart pump experiences once inserted into the patient's aorta. To establish this artificial environment, a passive circulatory loop with a single actuating element serving as a left ventricle for observation of undisturbed flow profiles in its proximity was designed. Furthermore, to simplify the search for hemodynamic states, it was required that both the detailed computer simulation and the physical system show a good match between the set parameters and the resulting signals.

Mock circulations often need to use a flow sensing system both on the aortic and mitral LV side to be able to construct exact pressure-volume (PV) loops [Tanne et al. 2009]. Using the advantages of the LV design in the presented system, an alternative technique for measurement of the LV volume and cardiac output is introduced that eliminates the need for such flow sensors and results in significant cost savings.

2. LUMPED PARAMETER MODEL OF THE MOCK CIRCULATION

Before the design of the hydraulic system could take place, a computer simulation of the planned system was done building onto the system model adapted from [Loh and Yu 2004]. The system was constructed following the physiological behaviour observed in the proximal region of a healthy human left ventricle, such as the left ventricular pressure (LVP), aortic pressure (AoP) and aortic flow (AoF).

This behaviour needed to be thoroughly analysed to be able to design a precise representation of the systemic circulation. The aortic response to the pressure curve of the left ventricle in the systole is divided into two sections. In the rising stage of the systolic LVP, the AoP is delayed compared to the LVP. During the declining stage, the aortic valve does not close instantly, but rather remains open for a certain period of time, which consequently leads to a fall of AoP [Kaniusas 2012]. The reason for the extended opening of the aortic valve comes from the mass inertia of blood which, together with the dirotic notch and the overall appearance of the flow and pressure curves, had to be successfully implemented.

2.1. Lumped parameter model

The developed hydraulic system was based on the lumped systems modelling, which enabled us to simulate the hydraulic and mechanical systems using analogous electrical elements. It does not include more advanced phenomena such as the

effect of medications, which will be considered once the first results of the LVAD's functionality in animal trials become available. All the lumped elements were dimensioned according to their hydraulic originals. This included the simulation of resistances, exact tube dimensions for inductances, aortic and mitral valve with inherent backflow, systemic and peripheral compliance, and the density and viscosity of the used liquid, both for water and 40% glycerine-water mixture. The computer simulation was performed in the Matlab/Simulink environment using the Simscape toolbox.

2.2. Model components

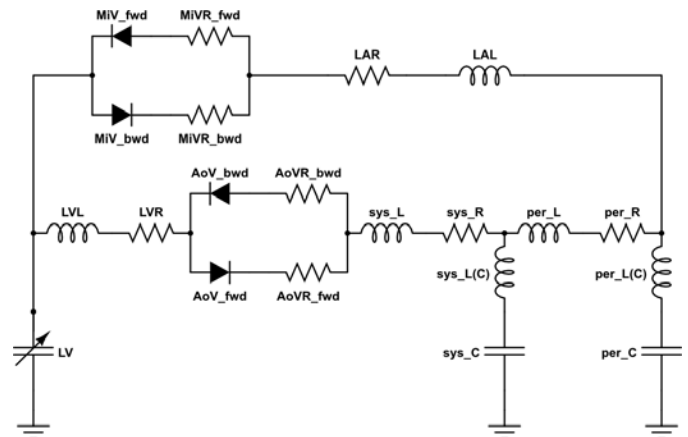

Fig. 1. Lumped parameter model of the mock circulation.

The model, as shown in Fig. 1, consists of several groups of elements based on the hemodynamic behaviour of the circulatory system at different stages over a single heartbeat. The precharged variable capacitor represents the left ventricle *LV*, i.e. the myocardium. The rest of the system is based on the 3rd order Windkessel model with added inductances throughout the system.

The portion of the model mainly responsible for the system's behaviour during systole consists of elements between the *LV* and the systemic compliance *sys_C* with the liquid stored in it having inductance *sys_L(C)*. These are the *LV* and systolic resistances *LVR* and *sys_R*, respectively. Introduced inductive elements *LVL* and *sys_L* result in an added kinetic energy to the system and extended systolic opening of the aortic valve.

Diastolic backflow over the aortic valve can be neglected due to a large value of the backflow aortic valve resistance *AoVR_bwd* in comparison to the forward one (*AoVR_fwd*). Two processes occurring in parallel define the circulation behaviour during the diastole. The first phenomenon is the delivery of liquid stored in the systemic compliance to the periphery. Released liquid is collected in the peripheral compliance *per_C* having the peripheral inductance *per_L(C)*, while the speed of the outflow and the aortic pressure loss are regulated by the peripheral inductance *per_L* and resistance *per_R*. The second phenomenon is the inflow of blood from the mitral side over the mitral valve into the *LV*. Inflow is shaped by the left atrial inductance *LAL* and resistance *LVL*. Since the pressure in the physiological left atrium remains at approximately the same level over a whole heartbeat, the *LV* must perceive a virtually constant hydrostatic pressure on the

mitral side. To realize this, the value of the peripheral compliance needs to be large.

2.3. Simulation results

An example of the simulated aortic pressure in comparison with the measured aortic pressure using the same LV pressure reference is shown in Fig. 2. It is important to emphasize that the values of the lumped elements match their hydraulic analogies.

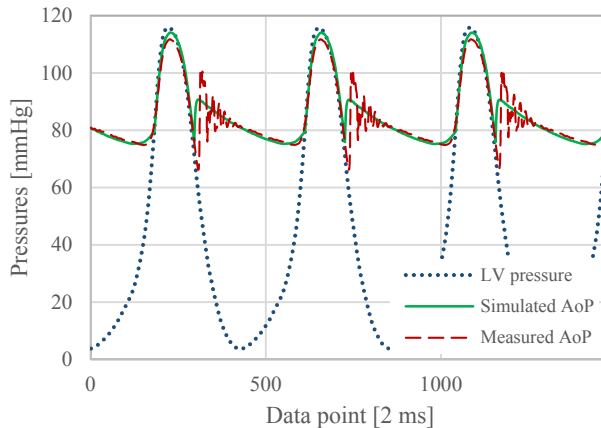

Fig. 2. Simulated vs. measured aortic pressure with the same LV pressure reference. Lumped model parameters: $LVL = 2.1 \cdot 10^5 H$, $LVR = 1.9 \cdot 10^4 \Omega$, $sys_L = 3.7 \cdot 10^5 H$, $sys_R = 4.7 \cdot 10^6 \Omega$, $sys_C = 1.7 \cdot 10^{-8} F$, $per_L = 5.1 \cdot 10^5 H$, $per_R = 7.5 \cdot 10^7 \Omega$, $per_C = 1.8 \cdot 10^{-6} F$, $LAL = 10^6 H$, $LAR = 3.9 \cdot 10^4 \Omega$.

Large resemblance is noticeable between the simulation and the constructed hydraulic mock circulation. Late closure of the aortic valve takes place with the occurrence of the dicrotic notch. End systolic and end diastolic aortic pressures also match, which confirms correct dimensioning of the circulatory components.

3. CONSTRUCTION OF THE HYDRAULIC SYSTEM

The construction of the hydraulic circulation was based on results acquired from the simulation in the lumped system model. Dimensions of the system and its components came as a direct translation from the optimum found in the simulation, at the same time looking after the size restrictions posed by the LVAD. Components of the mock circulation needed to provide enough flexibility to simulate a wide range of states, with modular design enabling simple modifications to the system.

3.1. Left ventricle

The left ventricle was constructed as a hermetically closed cylindrical chamber. It is connected via tubing to an electrical-pneumatic cylinder system driven by a DC motor. Together they simulate a periodically contracting and relaxing myocardium. Two different approaches for actuating the liquid flow through the system were used (Fig. 3).

Initially, the liquid phase was directly connected to the piston moved by the DC motor, having the LV completely filled with liquid. Theoretically this would have enabled direct control of the LV volume by adjusting the piston's position, but was

quickly abandoned due to significant pressure transients that were observable in the measurements throughout the system.

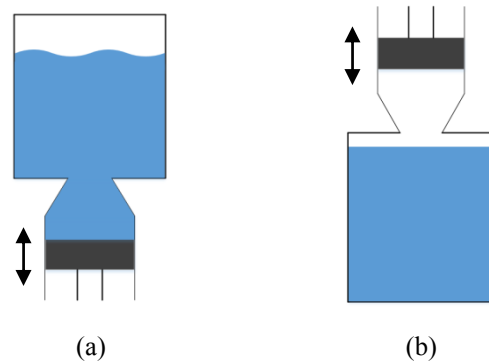

Fig. 3. LV actuation: (a) direct movement of the liquid phase, (b) compression of the pneumatic interface.

The second iteration of the same approach introduced an air cushion to dampen the significant oscillations in pressures in the system (Fig. 3a). Although the pressures in the rest of the system reached their design values, the response of the LV pressure remained unsatisfying (Fig. 4). Throughout the pressure signal a noisy response could be observed. As the piston's cross sectional area that is in direct contact with the liquid phase is smaller than the cross-sectional area of the LV reservoir, the liquid volume is not equally moved in the upward and downward directions. This leads to an occurrence of surface waves that change the hydrostatic pressure at the point of the LV pressure measurement and lead to the acquisition of a noisy LVP signal. Secondly, at points of the piston's direction change a high frequency, larger amplitude noise is measured. What is experienced is the phenomenon of water hammers.

Water hammers belong to pressure transients observable in fluid systems that occur each time a change in fluid velocity takes place by creating local over- and underpressure regions [Mays 2004]. Although they always happen both during gradual and sudden changes, it is the latter that is referred to as problematic. Typical events of water hammers in hydraulic systems take place after valve closures and openings, as well as at the changes of pumping direction in hydraulic pumps.

The alternative was to compress the air cushion directly (Fig. 3b). A large advantage of having a pressurized pneumatic phase in contact with the liquid surface is an approximately equal distribution of pressure throughout the air cushion. This is explained by the air's low density which keeps the influence of elevation change and so called minor losses in pipes at a minimum value. Together with a dampening effect on any occurring water hammers, the result was an evenly distributed air pressure across the surface. The smooth LV pressure response created using this method is shown in more detail in Fig. 4. This approach was therewith adopted in the system's construction.

The LV has the dimensions of 20 cm height and 15 cm diameter and is connected to the piston using a tube with an inner diameter of 2.54 cm and 30 cm length. The actuator consists of the Parker PID-S063MS pneumatic cylinder connected to the Festo DNCE-40-300-BS-12.7P-Q electrical

cylinder. These are driven by the Kollmorgen AKM32H-ANCNC-00 DC motor. Medical valve replacements from Edwards Lifesciences were used as the aortic and mitral valves.

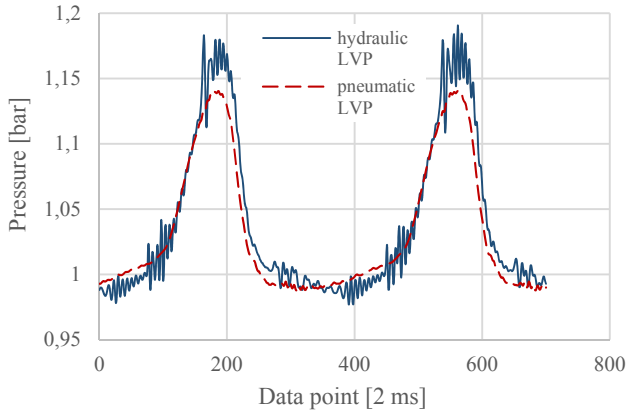

Fig. 4. LVP response with hydraulic and pneumatic actuation.

3.2. Proximal systemic circulation

The aortic valve was directly attached to the left ventricle and connected via a 10 cm polyurethane tube to a systemic compliance chamber. The option to use ball valves as resistive elements was quickly abandoned, since their resistance value depends nonlinearly on both flow and pressure difference. Instead, a laminar resistance element was used in form of the two metallic plates that compresses the tube over a 1 cm length. An added resistance value of a laminar resistance depends linearly on the cross-sectional shape of the tube. In case of a rectangular cross-section, resistance is expressed as

$$R = 12 \frac{\eta l}{bd^3}, \quad (1)$$

with l being the length of the compressed tube, and b and d being the width and height of the tube's inner cross-section, respectively [Leliveld 1974].

The value of the hermetically closed compliance can be modified following a linearized equation:

$$C_{sys} = \frac{V_a}{P_a} \quad (2)$$

Changes to its value are made by changing the initial air volume V_a and pressure P_a . Changing the initial air pressure was not an option, since any initial overpressure in the system gets distributed among the elements, pushing the air pressure back to the atmospheric value. This means that the initial air volume, i.e. the initial liquid volume is the only parameter determining the compliance value.

Since the behaviour of the compliance is nonlinear in nature, a more precise equation was developed that determines the initial liquid height h_i (3) in the compliance before the start of an experiment using the ideal gas law for isothermal gas process. This is the filling height of liquid in the compliance at atmospheric pressure. It depends on the minimum and maximum aortic pressures p_i and p_f over a single heart beat at the stroke volume SV , with H_{eff} being the effective height of

the compliance chamber that is measured from the middle point of the liquid's entry rather than from the bottom of the reservoir. $R_C^2 \pi$ is the area of the bottom side and ρ is the liquid's density. This equation, although very useful, is only an approximation since it assumes that the complete stroke volume gets stored in the compliance during systole, which is not the case in reality since the liquid continuously flows out of it over a heartbeat.

$$h_i = \frac{(p_f - p_i)H_{eff}}{p_f - p_i - 2\rho g \frac{SV}{R_C^2 \pi}} - \frac{\left(p_f + \rho g H_{eff} + \rho g \frac{SV}{R_C^2 \pi}\right) \frac{SV}{R_C^2 \pi}}{p_f - p_i - 2\rho g \frac{SV}{R_C^2 \pi}} \quad (3)$$

3.3. Periphery

The peripheral resistance was achieved using a laminar resistance 2 cm in length. The lumped parameter model indicated a large peripheral compliance. Theoretically, the largest possible value corresponds to an open reservoir. In comparison to the hermetically closed compliance in (2), its value depends solely on the bottom area A_{per} and the liquid's density ρ as in (4).

$$C_{per} = \frac{dV}{dp} = \frac{A_{per} dh}{\rho g dh} = \frac{A_{per}}{\rho g} \quad (4)$$

For connection between the systemic and peripheral compliances a 25 cm long polyurethane tube with a 2.54 cm inner diameter was used, while a 50 cm long tube of the same type connects the peripheral reservoir to the left ventricle.

4. CONTROL AND ACQUISITION SYSTEM

Measurements acquired from the mock circulation and the LVAD were collected using an NI CompactRio system at a rate of 500Hz. The same system also controlled the actuator.

4.1. Actuator control

The control of the DC motor connected to the electrical cylinder was realized within the NI SoftMotion module using the available functions in the Scan Engine mode. The position reference was given using a separate motion table for each pumping frequency, i.e. heart rate. Motor's amplitude, heart rate and motion shape can be changed during the experiment.

4.2. Flow measurement

The largest challenge in the measurement system was the determination of flow. Highly dynamic flow sensors that do not come in direct contact with the liquid were a possible option, but were avoided due to their excessive costs. Since the static LVAD testing was carried out before the insertion into the pulsatile environment of the mock circulation, flow sensors that were used for static tests were also tried out in the mock circulation. Those were the optical Swissflow SF800-6 and ultrasonic Cynergy3 UF25B flow sensors, both with 3/8"

inner diameter. Despite using optimization techniques for reducing major and minor pressure losses, the added resistance from the sensors to the system was too large, which made them inapplicable for the dynamic flow measurement.

The solution was achieved by combining the advantages of the mock circulation's design with the available measurements. The left ventricle is physically connected to the moving piston and partially filled with trapped air. Using the encoder signal from the motor, we can determine an exact position of the piston in the pneumatic cylinder that compresses the trapped air. Since the LV can be completely isolated from the rest of the circulation, its parameters, like the initial air volume between the piston and liquid's surface in the LV, could be well estimated.

The critical idea was to back calculate the LV volume (LVV) using the measurement of the static pressure in trapped air. Starting from the assumption that the air compression process corresponds to a polytropic thermodynamic process pV^n , for small piston amplitudes the polytropic index n remained in region $n \in [0.98, 1.02]$ that approximately corresponds to an isothermal process. An example of the air pressure response at large amplitude references is shown in Fig. 5. The ideal pressure response should reach its stationary value by the end of the motor's motion, but a clear overshoot is observable due to an unsteady thermodynamic process taking place.

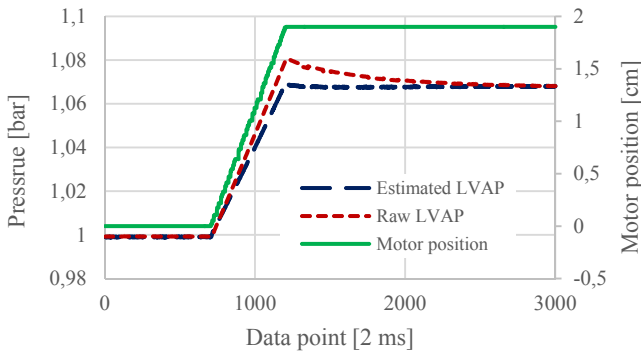

Fig. 5. Response of raw and estimated LVAP to the piston's position change.

The raw LV air pressure LVAP behaves as a first order system with a zero that results in a positive overshoot. To be able to apply stationary isothermal equations, the air pressure without observable transients needed to be estimated. The estimation procedure was executed using the System Identification Toolbox in Matlab. The pressure behaviour of the pneumatic phase is described by a linear equation:

$$G_{LVA}(s) = \frac{1 + 1.3232s}{1 + 1.68s} \quad (5)$$

The estimated LVAP is calculated by using the raw LVAP measurements filtered by the function in (5) and discretized using the backward Euler method.

The quantity of liquid that flows out from the LV into the aorta can be calculated by (6), where p_0 and V_0 represent initial air pressure and volume, respectively, with $p(t)$ being the estimated LVAP signal. $V_a(t)$ is the amount of air volume restricted by the piston's movement as expressed in (7). A is

the piston's surface area and $s(t)$ the piston's position.

$$V_w(t) = \frac{p_0 \cdot V_0 - p(t) \cdot [V_0 - V_a(t)]}{p(t)} \quad (6)$$

$$V_a(t) = A \cdot s(t) \quad (7)$$

The developed flow sensing method was compared to the Cynergy3 ultrasonic flow sensor. Results are shown in Fig. 6 for a flow of approx. 21ml.

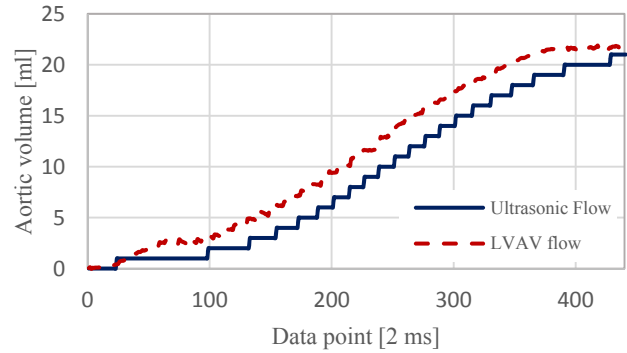

Fig. 6. Comparison of unfiltered measurements using the ultrasonic and newly developed LVAV flow sensing principle.

Significant advantages of the developed method are its good dynamic properties with a very good accuracy. It is possible to measure the LV volume both in the systole and diastole, thereby eliminating the need for a pair of sensors, each measuring the flow on the aortic and on the mitral side. Added cost to the system equals the cost of a single pressure sensor. One is able to use the measurement method for liquids of all viscosities without the need for any additional calibration. As this is a contactless method, no additional resistances or other disturbances are introduced to the hydraulic system.

On the negative side, the introduced method requires a good system model like in (5) to work properly. For a correct functionality one needs to initialize the measurement by estimating the initial air volume V_0 using the above described technique, as well as use an actuator with a position feedback.

4.3. Other measurements

Other signals of interest are the left ventricular pressure and the aortic pressure, with both pressure sensors being positioned on the same height to eliminate any hydrostatic pressure differences. Honeywell 142PC15D pressure sensors were chosen for all pressure measurements in the system, including the LVAP. Temperature of the liquid was measured with a PT100 temperature sensor from RS Components. Honeywell 2SS52M Hall sensors were built into the housing of the LVAD for the measurement of the rotational speed.

5. RESULTS

An extensive number of measurements was performed for determining the working range of the mock circulation. Results show that the available states range from 40-150 bpm for the heart rate, 5-100 ml for the stroke volume, 50-180 mmHg for the LVP and 20-180 mmHg for the AoP.

The construction of the system enables the simulation of both a healthy and a pathological heart in different conditions. The main goal in setting up the piston's motion and values of the passive hydraulic elements was the achievement of necessary left ventricular ejection fractions of a heart that experienced an acute myocardial infarction (AMI). The circulation behaviour at the chosen state is then further described using the PV loops. An example of a weakened heart is shown in Fig. 7.

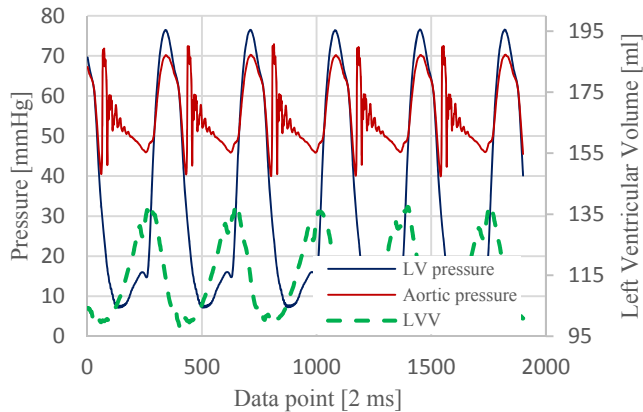

Fig. 7 Unfiltered LVP and AoP curves using water, together with LVV of a simulated pathological heart; HR = 81, SV = 38 ml, SBP/DBP = 70/50 mmHg, LVEF 28%

Fig. 7 shows main properties of the designed system. As predicted in the simulation, late closure of the aortic valve and the appearance of the dicotic notch are present. The LVV signal also resembles the physiological behaviour. As the point of the AoP measurement is positioned around 2 cm from the aortic valve without any hydraulic dampening in between, influence of water hammers is observable in the output signal. These however quickly diminish further in the systemic tubing, which is why the tested heart pump will not experience such pressure transients. Additionally, during the tests with liquids of higher viscosities than water, such as 10% ethanol-water mixture, the amplitude of pressure transients declined, indicating that the water hammer effect weakens in liquids of an increasing viscosity.

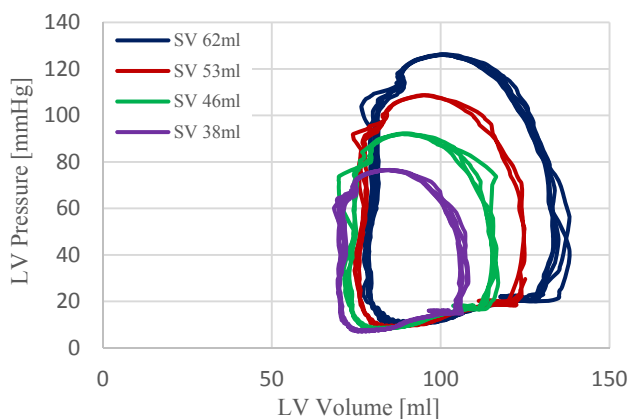

Fig. 8 PV Loops for a healthy (SV 62 ml) and a weakened left ventricle.

Fig. 8 shows the PV loops recorded by changing the amplitude of the piston, keeping the parameters of the hydraulic components constant. This demonstrates the ability of the

system to actively change certain hemodynamic parameters that can be used to simulate chosen physiological phenomena such as the influence of respiration or arrhythmias. These will be important later on in the project for optimizing the LVAD's control algorithms under changing working conditions.

6. CONCLUSION

The presented mock circulation represents a good approximation of the environment that the novel LVAD will be experiencing during the in-vivo trials. An alternative flow measurement method to commercially available solutions was presented. The ability to verify the influence of each hydraulic component on the total behaviour of the system in the developed simulation permits very precise adjustment of each hemodynamic state that needs to be achieved. Results show that the mock circulation is ready to be used for an extensive in-vitro testing of the LVAD currently in development.

ACKNOWLEDGMENT

This work was done within the Research Studio 'Assistocor', funded by the Austrian Federal Ministry for Economy, Family and Youth (BMWFJ) and operated by the Austrian Research Promotion Agency (FFG).

REFERENCES

- Brooker, G. (2012). *Introduction to Biomechatronics*, SciTech Publishing.
- Ferrari, G., Kozarski, M. and Other (2005). Development of Hybrid (Numerical-Physical) Models of the Cardiovascular System: Numerical-Electrical and Numerical Hydraulic Applications. *Biocybernetics and Biomedical Engineering*, 25(4), 3-15
- Kozarski, M., Ferrari, G. and Other (2003). A hybrid mock circulatory system: Development and testing of an electro-hydraulic impedance simulator, *The International Journal of Artificial Organs*, 26(1), 53-63.
- Kaniusas, E. (2012). *Biomedical Sensors and Signals*, Springer.
- Leliveld, W.H. (1974). *The Design of a Mock Circulation System*, Eindhoven.
- Loh, M. and Yu, Y.C. (2004). Feedback Control Design of an elastance-based mock circulatory system. *Proceedings of the American Control Conference*, 1639-1644.
- Mays, L. W. (2004). *Hydraulic Design Handbook*, Page 2.33. McGraw-Hill, Digital Engineering Library.
- Reul, H. (1992). Design, Development and Testing of Blood Pumps. *NATO ASI Series*, Vol. 235, 237-258.
- Spurlock, D.J., Ranney, D.N. and Other (2012). In Vitro Testing of a Novel Blood Pump Designed for Temporary Extracorporeal Support. *ASAIO Journal*, 58(2).
- Tanne, D., Bertrand, E. and Other (2009). Assessment of left heart and pulmonary circulation flow dynamics by a new pulsed mock circulatory system. *Experiments in Fluids*, 48(5), 837-850.
- Timms, D., Hayne, M. and Other (2005). A Complete Mock Circulation Loop for the Evaluation of Left, Right and Biventricular Assist Devices. *Artificial Organs*, 29(7), 564-572.