

Preventing Refrigerated Foodstuffs in Supermarkets from Being Discarded on Hot Days by MPC

J. Cai, J. Stoustrup* J. B. Joergensen**

*Automation and Control, Department of Electronic Systems, Aalborg University, 9220 Aalborg, Denmark. (e-mail: jc@es.aau.dk, jakob@es.aau.dk)

**Informatics and Mathematical Modelling, Technical University of Denmark (DTU), 2800 Lyngby, Denmark. (e-mail: jbj@imm.dtu.dk)

Abstract: This paper presents an optimization strategy for supermarket refrigeration systems. It deals with one special condition when the extremely high outdoor temperature causes the compressor to saturate, and work at its maximum capacity. In a traditional control, refrigerated foodstuffs inside display cabinets will suffer from a consequential higher temperature storage, which is detrimental to the food quality, and in worst cases they have to be discarded according to the regulation from authorities. This will cause a big economic loss to the shop owner. By utilizing the thermal mass of foodstuffs and their relative slow temperature change, Model Predictive Control (MPC), foreseeing this situation, it will use more compressor power to cool down the foodstuffs in advance, preventing the high temperature storage from happening, thus saving them from being discarded.

1. INTRODUCTION

Increasing energy costs and customer awareness on food safety and quality aspects impose a big challenge to the food industries, especially to supermarkets, which have a direct contact with consumers. A well-designed optimal control scheme, continuously maintaining a commercial refrigeration system at its optimum operation condition, despite changing environmental conditions, will achieve an important performance improvement, both on energy efficiency and food quality reliability.

Many efforts on optimization of cooling systems have been focused on optimizing objective functions such as the overall energy consumption, system efficiency, capacity, or wear of the individual component, see Jakobsen and Rasmussen [1998], Jakobsen et al. [2001], Larsen and Thybo [2004], Leduqa et al. [2006], Swensson [1994]. They have proved significant improvements of the system performance under disturbances, while there have been little emphasizes on the quality aspect of foodstuffs inside display cabinets.

This paper discusses an optimization strategy for commercial refrigeration systems, focusing on one special condition when the extremely high ambient temperature causes the compressor to saturate, and work at its maximum capacity. In such a case, if nothing is done, the accumulated detrimental effect of high temperature storage on food may cause them to be discarded. This optimization strategy will cool the foodstuffs in advance, and prevent it from happening.

The paper is organized as follows: the refrigeration process is described in Section 2. Problem analysis and expected solution from MPC is illustrated in Section 3. MPC basic is introduced in Section 4. MPC formulation of our problem is presented in Section 5, and followed by some simulation results, which is in Section 6. Finally some discussions and conclusions are given in Section 7.

2. PROCESS DESCRIPTION

A simplified sketch of the process is shown in Fig. 1. In the evaporator there is heat exchange between the air inside the display cabinet and the cold refrigerant, giving a slightly superheated vapor to the compressor. After the compression the hot vapor is cooled, condensed and slightly sub-cooled in the condenser. This slightly sub-cooled liquid is then expanded through the expansion valve giving a cold two-phase mixture.

The display cabinet is located inside a store. Condenser and condenser fans are located on the roof of the store. Condensation is achieved by the heat exchange with ambient air.

2.1 Mathematical model

Larsen [2005] provided a general introduction for modeling and parameter identifications of cooling systems. As illustrated in Fig. 1, the supermarket refrigeration system consists of a cooling system and a display cabinet. The dynamic of the cooling system is much faster than the dynamics of the foodstuffs inside

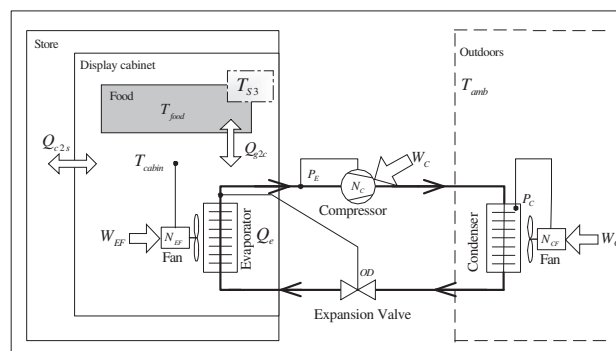

Fig. 1. Sketch of a simplified supermarket refrigeration system studied in this paper.

the display cabinet. Therefore we model the cooling system statically. The main modeling equations are given as follows:

$$W_C = \frac{m_{ref}}{\eta_{is}} \cdot (h_{is}(P_e, P_c) - h_{oe}(P_e)) \quad (1a)$$

$$m_{ref} = N_C \cdot V_d \cdot \eta_{vol} \cdot \rho_{ref}(P_e) \quad (1b)$$

$$Q_c = UA_c \cdot (T_c - T_{amb}) \quad (1c)$$

$$Q_e = UA_e \cdot (T_{cabin} - T_e) \quad (1d)$$

Where W is for power, m for mass flow rate, h for enthalpy, ρ for density, P for pressure, T for temperature, N for speed, Q for heat capacity, η for efficiency, UA for heat transfer coefficient, subscript C for compressor, c for condenser, e for evaporator, ref for refrigerant, amb for ambient, is for isentropic, oe for evaporator outlet, $cabin$ for cabinet, vol for volumetric.

The heat transfer coefficient are determined by the speed and parameters of the evaporator and condenser fan, as follows:

$$UA_c = \phi_1(N_{CF}, \alpha_c, m_c, K_{CF}) \quad (2a)$$

$$UA_e = \phi_2(N_{EF}, \alpha_e, m_e, K_{EF}) \quad (2b)$$

For the display cabinet and foodstuffs we use a dynamic model, as this is where the slow and important dynamics will be. Foodstuffs are lumped into one mass, and the air inside the cabinet together with walls are lumped into one mass, here we assume that there is only convective heat transfer between the foodstuffs and air. The modeling equations are given as follows:

$$\dot{T}_{food} = (mCp_{food})^{-1} \cdot Q_{c2f} \quad (3a)$$

$$\dot{T}_{cabin} = (mCp_{cabin})^{-1} \cdot (-Q_{c2f} - Q_e + Q_{load}) \quad (3b)$$

Where

$$Q_{c2f} = UA_{c2f} \cdot (T_{cabin} - T_{food}) \quad (4a)$$

$$Q_{load} = UA_{s2c} \cdot (T_{store} - T_{cabin}) \quad (4b)$$

Here we have to notice that for simplifying modeling, we assume that the air inside cabinets have a uniformed temperature. In a real refrigeration system, air temperature has a non-uniformed space distribution. Air after the evaporator (measured by one temperature sensor S_4) is colder than air return back to the evaporator (measured by S_3), this is mainly due

Table 1. Data for the simulation

Compressor
volumetric capacity: $V_d = 53.86 \text{ cm}^3$
volumetric capacity fraction: $\eta_{vol} = 0.7$
heat loss factor: $f_q = 0.20$
isentropic efficiency: $\eta_{is} = 0.5$
Evaporator
heat transfer constant: $\alpha_e = 1,170$
mass flow constant: $K_{EF} = 0.02 \text{ kg}$
heat transfer exponent: $m_e = 0.50$
fan speed: $N_{EF} = 40 \text{ s}^{-1}$
minimum pressure: $P_{e,min} = 2.0 \text{ bar}$
Condenser
heat transfer constant: $\alpha_c = 1,170$
mass flow constant: $K_{CF} = 0.02 \text{ kg}$
heat transfer exponent: $m_c = 0.50$
fan maximum speed: $N_{CF,max} = 60 \text{ s}^{-1}$
maximum pressure: $P_{c,max} = 11.0 \text{ bar}$
Display cabinet
parameter: $\alpha = 0.3$
heat transfer coefficient: $UA_{s2c} = 160 \text{ W K}^{-1}$
heat capacity: $mCp_{cabin} = 50 \text{ kJ K}^{-1}$
heat transfer coefficient: $UA_{c2f} = 15.0 \text{ W K}^{-1}$
heat capacity: $mCp_{food} = 400 \text{ kJ K}^{-1}$

to heat loads from infiltrations, radiations, heat conduction and convection, etc. A real controller will use either one or two these measured temperatures. Here we assume the controller will use T_{S3} , as illustrated in Fig. 1, it can be estimated as follows.

$$T_{S3} = \alpha \cdot T_{cabin} + (1 - \alpha) \cdot T_{food} \quad (5)$$

When air and foodstuffs have the same temperature, T_{S3} will have the same temperature as them as well, but when air and food temperature is different, T_{S3} will be at a temperature in between, α can be approximated by heat transfer between two fluids, where one of them has isothermal temperature.

Larsen [2005] identified the parameters for the cooling system, they are given in Table 1. Data for thermal capacity and heat transfer coefficient inside the display cabinet are approximated to simulate a real plant.

2.2 Requirements on food storage temperature

In supermarkets, there are general requirements regarding the storage temperature for different foodstuffs in display cabinets. For example in Denmark, according to Announcement [2004] and DSK et al. [2004].

- Frozen food, the maximum temperature is -18°C .
- Fresh fish and products, the maximum temperature is $+2^\circ\text{C}$.
- Milk, the maximum temperature is $+5^\circ\text{C}$.

The temperature here is the air temperature. In addition, there are also temperature requirements during food processing and transportation.

3. PROBLEM ANALYSIS

3.1 What is the problem?

The refrigeration system in a supermarket works all year round. Normally each compressor or a group of compressors have a fixed cooling capacity, which can cope with the most common applications for that specific supermarket (here we use a system with single compressor as an example). If one day in summer, the outdoor temperature is extremely high, even when the compressor works at the maximum capacity, it still can not meet the required cooling demand. In this case, air temperature inside the display cabinet T_{cabin} will rise, so will the food temperature T_{food} . Since the controller actually controls T_{S3} , so the compressor in this situation will work continually at the saturated condition until T_{S3} back to normal level, as illustrated in Fig. 2. Depending on the seriousness of situation, sometimes, the stored foodstuffs have to be discarded according to the regulation from food authorities.

3.2 Why MPC?

In this case, we need to look for the future disturbance, that is the weather condition. Handle constraints, both from inputs (such as the mechanical limitation of components) and outputs (such as the required storage temperature). Work with nonlinearities caused by saturation. The properties of this problem determine that MPC to be one of the most suitable approaches.

MPC as one candidate, has several technical advantages, for examples, explicit process models allow control of difficult

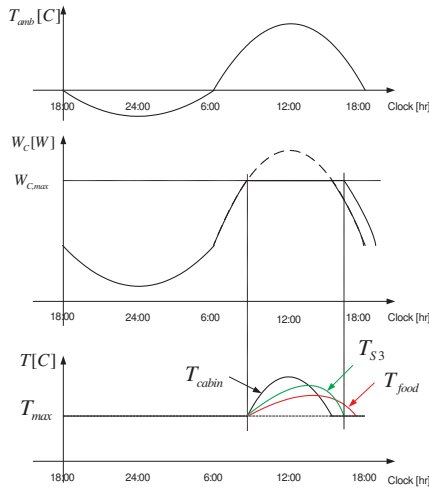

Fig. 2. Saturation happens, T_{cabin} and T_{food} rise, compressor works at saturation until T_{S3} back to normal.

dynamics, such as: dead-time (time delay); inverse response; interactions (multivariate); nonlinearity. Optimization of future plant behavior handles, such as: feedforward from measured or estimated disturbances; feedforward from setpoint changes and desired future trajectory; feedback. Handling of input and output constraints, see Maciejowski [2002].

Based on the features of MPC controller, we expect the controller to take measures beforehand, when it can foresee the potential problem, in order to meet the constraints on both inputs and outputs.

4. MODEL PREDICTIVE CONTROL

4.1 MPC principle and basic idea:

MPC or receding horizon control (RHC) is a form of control in which the current control action is obtained by solving on line, at each sampling instant, a finite horizon open loop optimal control problem, using the current state of the plant as the initial state; the optimization yields an optimal control sequence and the first control in the sequence is applied to the plant. This is its main difference from the conventional control which uses a pre-computed law. The basic idea of MPC is illustrated in Fig. 3.

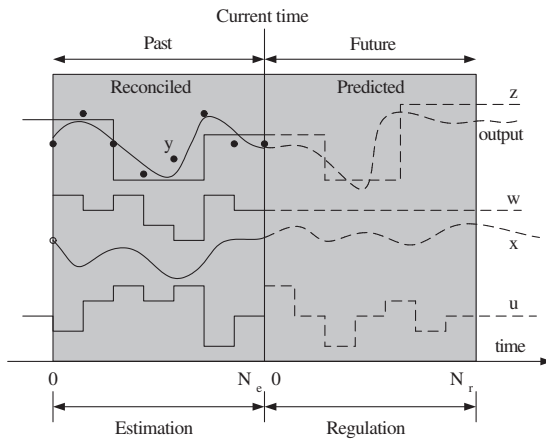

Fig. 3. MPC Basic Idea- Regulation and Estimation Problem

5. PROBLEM FORMULATION IN MPC

5.1 Degree Of Freedom (DOF) analysis

There are four degrees of freedom (input) in a simple refrigeration system. They can be recognized in Fig. 1 as the compressor speed N_C , condenser fan speed N_{CF} , evaporator fan speed N_{EF} and opening degree (OD) of the expansion valve .

Here we assume a constant super-heat ($\Delta T_{sh} = 3^\circ\text{C}$), it is controlled by adjusting the OD of the expansion valve. This will consume one DOF.

So we are left with three unconstrained degrees of freedom that should be used to optimize the operation. They are:

- (1) Compressor speed N_C
- (2) Condenser fan speed N_{CF}
- (3) Evaporator fan speed N_{EF}

These inputs are controlling three variables:

- (1) Evaporating pressure P_e
- (2) Condensing pressure P_c
- (3) Cabinet temperature T_{cabin}

However, the setpoints for these three variables may be used as manipulated inputs in our study, so the number of degrees of freedom is still three.

5.2 MPC controller

To deal with the problem stated above, preventing foodstuffs from being discarded by the most energy efficient way, we design MPC as follows, and shown in Fig. 4. Here, due to unique relation between the saturation temperature and pressure of refrigerant, we use the setpoint of evaporating temperature T_e , condensing temperature T_c and cabinet temperature T_{cabin} as the manipulated inputs, so the total DOF is still three. According to Jakobsen and Skovrup [2001], there always exists one optimal temperature difference between T_c and outdoor ambient temperature T_{amb} . In most cases, it is a constant. For simplification, we fix T_c by 10°C higher than T_{amb} , this consumes one DOF. T_{cabin} is one of the controlled outputs here. Therefore we have one DOF left, that is T_e . T_{amb} and T_{store} are measured disturbances, T_{cabin} , T_{food} , T_{S3} and W_c are controlled outputs.

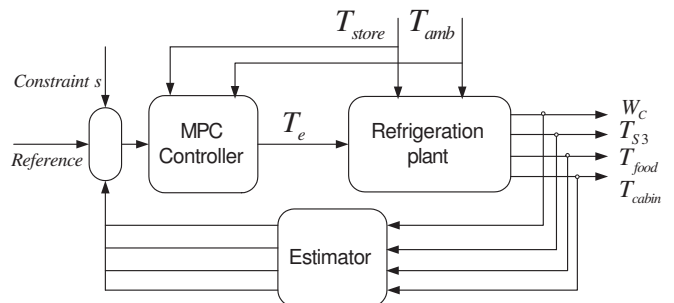

Fig. 4. MPC controller with observer

From 3 and 4, we get the following ODEs:

$$\dot{T}_{food} = f_1(T_{food}, T_{cabin}) \quad (6a)$$

$$\dot{T}_{cabin} = f_2(T_{cabin}, T_{food}, T_{store}, Q_e) \quad (6b)$$

Where:

$$Q_e = f_3(T_e, T_{cabin}) \quad (7)$$

Equation 7 is derived from 1d and 2b, where we assume that evaporator fan has a constant speed.

Together with initial conditions, we can rewrite 6 as the following:

$$\dot{T}_{food} = f_1(T_{food}, T_{cabin}) \quad (8a)$$

$$\dot{T}_{cabin} = f_4(T_{cabin}, T_{food}, T_{store}, T_e) \quad (8b)$$

$$T_{cabin}(t_0) = T_{cabin,i} \quad (8c)$$

$$T_{food}(t_0) = T_{food,i} \quad (8d)$$

The controlled outputs of the system are:

$$T_{food} = g_1(T_{food}, T_{cabin}) \quad (9a)$$

$$T_{cabin} = g_2(T_{food}, T_{cabin}, T_{store}, T_e) \quad (9b)$$

$$T_{S3} = g_3(T_{food}, T_{cabin}) \quad (9c)$$

$$W_c = g_4(T_e, T_{amb}, T_{store}) \quad (9d)$$

Equation 9d is non linear, derived from 1a, 1b, 1c, 2a, plus some equations correlating refrigerant properties, such as from the saturation temperature to pressure P , from pressure to enthalpy h , etc.

Linearization around one steady state equilibrium point, we can get the linear continuous state space model in deviation form as follows:

$$\dot{x} = A_c \cdot x + B_c \cdot u + E_c \cdot d \quad (10a)$$

$$y = C_y \cdot x + D_{yu} \cdot u + D_{yd} \cdot d \quad (10b)$$

Where

$$x = [T_{cabin} - T_{cabin,s}, T_{food} - T_{food,s}]'$$

$$u = [T_e - T_{e,s}]'$$

$$d = [T_{amb} - T_{amb,s}, T_{store} - T_{store,s}]'$$

$$y = [T_{cabin} - T_{cabin,s}, T_{food} - T_{food,s}, T_{S3} - T_{S3,s}, W_c - W_{c,s}]'$$

5.3 Set up the problem by using MPC toolbox in MatlabTM

The above MPC controller is set up in MatlabTM by using MPC toolbox.

Constraints:

$$u_{jmin}(i) - \varepsilon V_{jmin}^u(i) \leq u_j(k+i|k) \leq u_{jmax}(i) + \varepsilon V_{jmax}^u(i)$$

$$\Delta u_{jmin}(i) - \varepsilon V_{jmin}^{\Delta u}(i) \leq \Delta u_j(k+i|k) \leq \Delta u_{jmax}(i) + \varepsilon V_{jmax}^{\Delta u}(i)$$

$$y_{jmin}(i) - \varepsilon V_{jmin}^y(i) \leq y_j(k+i+1|k) \leq y_{jmax}(i) + \varepsilon V_{jmax}^y(i)$$

$$\Delta u(k+h|k) = 0$$

$$i = 0, \dots, p-1$$

$$h = m, \dots, p-1$$

$$\varepsilon \geq 0$$

Where $u_{min}, u_{max}, \Delta u_{min}, \Delta u_{max}, y_{min}, y_{max}$ are the lower and upper bound for $u, \Delta u, y$ respectively, they are relaxed by introduction of the slack variable ε . Normally all the input constraints are hard, such that $V_{jmin}^u, V_{jmin}^{\Delta u}, V_{jmax}^u, V_{jmax}^{\Delta u} = 0$, while all output constraint constraints are soft, as hard output constraints may cause infeasibility of the optimization problem. In our case, constraint on input T_e is determined from the condition that $P_{e,min} = 2.0$ bar and $P_e < P_c$, T_c is between 30 and 40°C, so T_e is constrained within a lower and upper bound of -10 and 10°C. The change rate of T_e is selected to be within a lower and

upper bound of 2°C. Constraints on outputs will be discussed in details later.

Cost function: the cost function with soft constraints is formulated as the following form:

$$\min_{\Delta u(k|k), \dots, \varepsilon} \left\{ \sum_{i=1}^{P-1} \left(\sum_{j=1}^{n_y} |w_{i+1,j}^y (y_j(k+i+1|k) - r_j(k+i+1))|^2 + \sum_{j=1}^{n_u} |w_{i,j}^{\Delta u} \Delta u_j(k+i|k)|^2 \right) + \rho_\varepsilon \varepsilon^2 \right\}$$

Where w^y and $w^{\Delta u}$ are the weighting factor for the output deviations from the references and input changes respectively, weight ρ_ε on the slack variable ε penalizes the violation of the constraints.

6. SIMULATION RESULTS

Here we use one case to illustrate the basic principle. Foods here are fresh fish products with a recommended maximum storage temperature of 2°C. We assume ambient temperature T_{amb} fluctuates during day and night as a sinusoidal function, with a nominal value of 25°C, amplitude of 5°C, period of 24 h. Furthermore, we assume that store has a constant temperature of 20°C, weather forecast is reachable 24 h in advance. There will be two scenarios:

The compressor has a sufficient capacity: if the compressor has a sufficient capacity, it will be capable of maintaining the cabinet, food and S3 temperature at their setpoint, for example 2°C, no matter how the ambient condition changes. In this case, the compressor works hard, when T_{amb} is high. The simulated outputs are shown in Fig. 5. The input for the controller T_e and disturbances from T_{amb} and T_{store} are shown in Fig. 6.

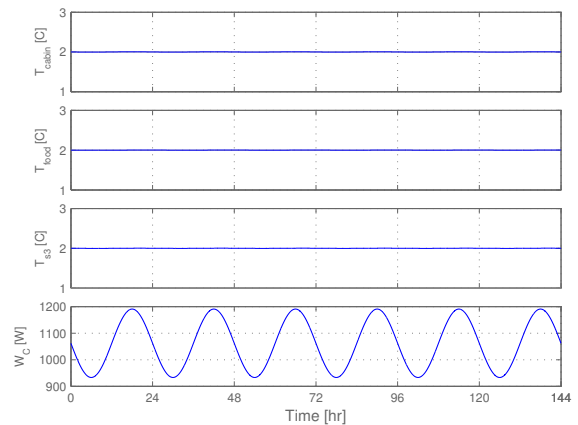

Fig. 5. Compressor has a sufficient capacity, to maintain T_{cabin} , T_{food} and T_{S3} at their setpoint of 2°C.

The compressor has a limited capacity: for example that the compressor has a maximum capacity of 1,150 W. It is sufficient for most of cases, but not for the case when T_{amb} is higher than 29°C. Under this situation, compressor will work in a saturated condition, at its maximum power. It is not enough to maintain the required cabinet and food temperature, both of them will increase accordingly. Compressor will work continually at the saturated condition until T_{S3} back to normal setpoint. The

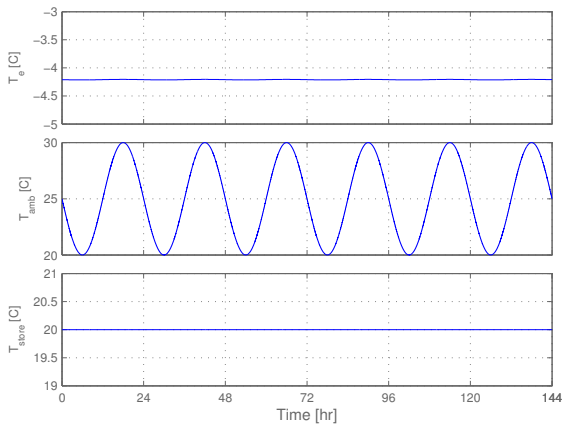

Fig. 6. The input of the controller T_e and disturbances from T_{amb} and T_{store} , when compressor has a sufficient capacity.

simulated outputs are shown in Fig. 7. Input T_e is shown in Fig. 8, disturbances from T_{amb} and T_{store} are the same as in Fig. 6 for all the cases.

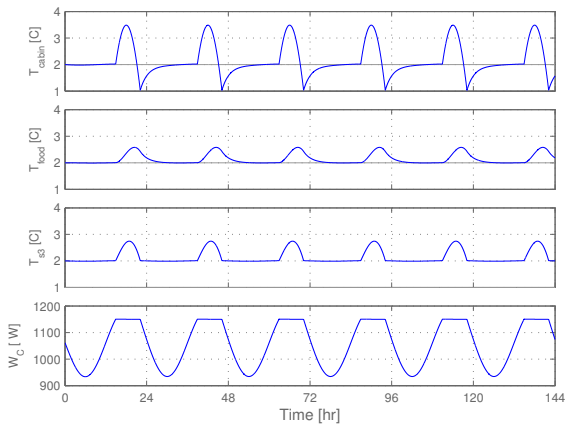

Fig. 7. Saturation happens, T_{cabin} and T_{food} rise, compressor works at saturation until T_{S3} back to normal level.

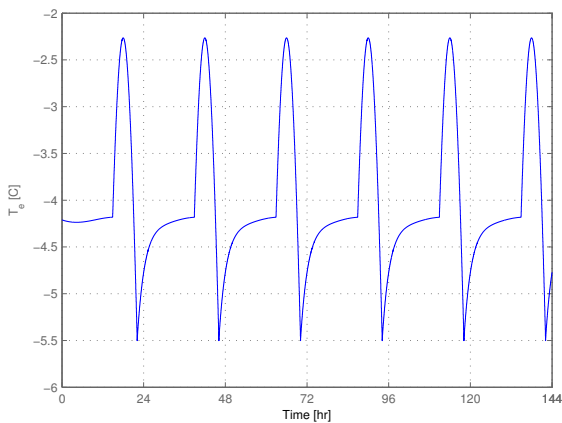

Fig. 8. Input of controller T_e , when saturation happens.

As we can see from Fig. 7, if nothing is done, foodstuffs will be stored at a temperature higher than its maximum allowable temperature. According to the relation between food temperature and quality, it is detrimental to the food quality, see Cai et al. [2006]. In the worst case, they have to be discarded, according to the regulation from food authorities. This will cause a big economic loss to the supermarket owner.

Optimization strategy by MPC: the strategy is to use the thermal mass of the food and their relative slow temperature change, as well as the significant advantage of MPC controller, to cool down the food beforehand, preventing the high temperature storage from happening. In this case, we have the constraint on the output W_C with an upper bound 1,150W, at the same time, we have also the constraint on the food temperature T_{food} , with an upper bound of 2°C and a lower bound of 0°C. The reason that we set a lower bound for the food temperature is that we do not want the fresh fish to be frozen. We use the sampling time of 1 h, prediction horizon of 24 h, and controlled horizon of 12 h. References for outputs T_{cabin} , T_{food} , T_{S3} are set as their steady state values, the reference for W_C is set as 0W, by this way, system will try to find the most energy efficient way. Weight w^y for outputs T_{cabin} , T_{food} , T_{S3} , W_C are set to be 1,000, 0, 0, 1 respectively, and weight $w^{\Delta u}$ for ΔT_e is 1,000. The simulated outputs for this case are shown in Fig. 9. Input is shown in Fig. 10.

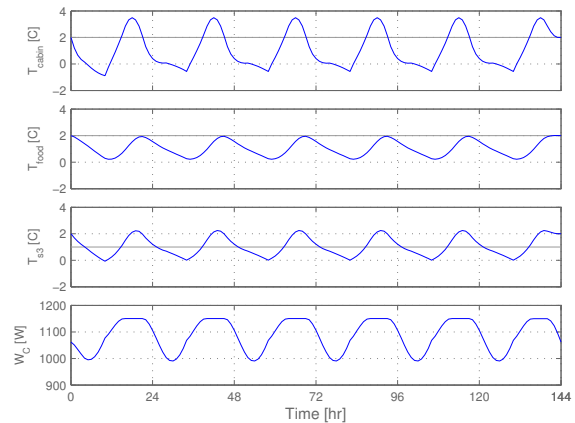

Fig. 9. With MPC, compressor works harder beforehand, to prevent T_{food} from exceeding its maximum value 2°C.

Comparison: A comparison of the MPC optimization strategy with the cases under sufficient capacity and normal saturation is shown in Fig. 11 and Fig. 12. From figures, we can see that MPC forces the compressor to use much more power beforehand (red), comparing with normal saturation (green), in order to satisfy the constraint on food temperature. The inputs of the controller T_e under these three cases are shown in Fig. 13.

7. DISCUSSION AND CONCLUSION

This paper using one example, discussed the problem related with the traditional control, when the high ambient temperature causes the compressor to saturate. The accumulated effect of high temperature storage on foodstuffs will cause an extra quality loss. In the worst cases, they have to be discarded according

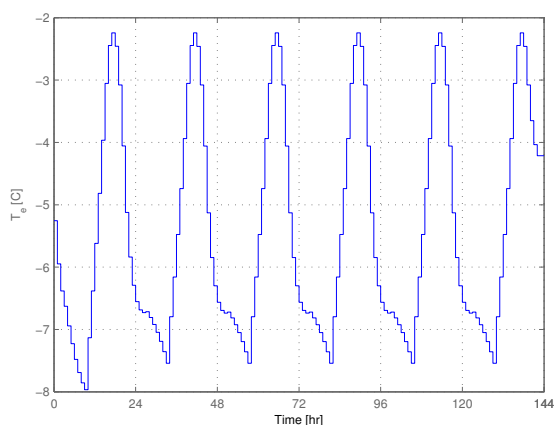

Fig. 10. Input of controller T_e under MPC

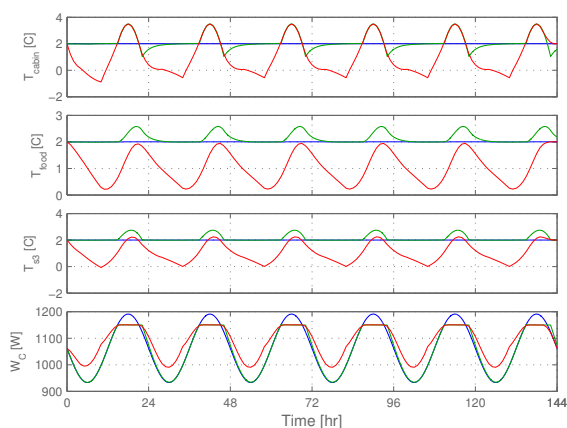

Fig. 11. Comparison of temperature and power, under sufficient capacity (blue), normal saturation (green) and MPC (red).

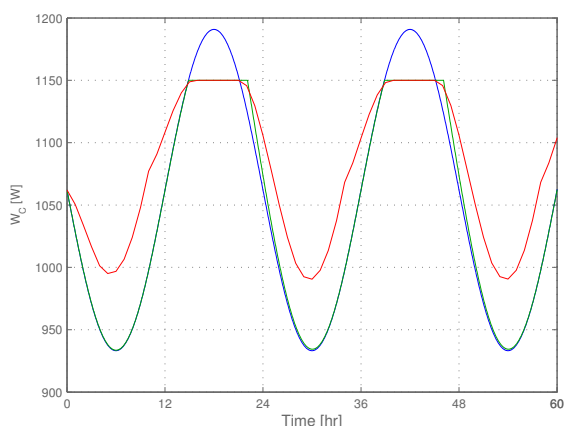

Fig. 12. Comparison of power W_c , under sufficient capacity (blue), normal saturation (green) and MPC (red)-zoomed.

to the regulation. To solve this problem, MPC will by utilizing the thermal mass of refrigerated foodstuffs and their relative slow temperature changes, cool down them more beforehand,

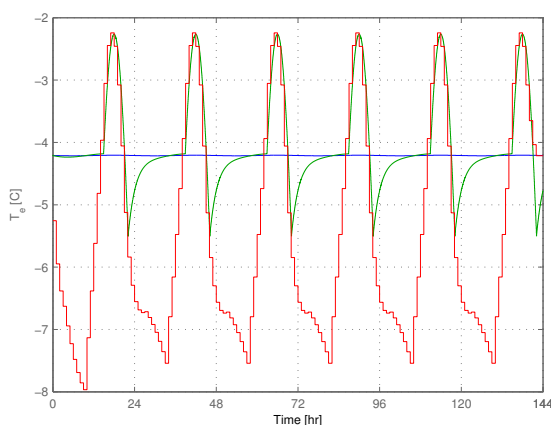

Fig. 13. Comparison of T_e , under sufficient capacity (blue), normal saturation (green) and MPC (red).

preventing the high temperature storage from happening, thus saving them from being discarded.

ACKNOWLEDGEMENTS

The authors gratefully acknowledge the sponsorship of the Center for Model Based Control and Monitoring (CMBC), Denmark.

REFERENCES

Announcement. *Announcement 1271 of 13/12/2004 concerning hygiene of foodstuffs by Danish authorities*, <http://www.foedevarestyrelsen.dk>. 2004.

J. Cai, J. Risum, and C. Thybo. Quality model of foodstuffs in a refrigerated display cabinet. Purdue, USA, 2006. 11th Int. Refrigeration and Air Condition Conference.

DSK, Danish Supermarket Group, and COOP. *Hygiene and Self Control, Regulation for Supermarkets*. 2004.

A. Jakobsen and B. D. Rasmussen. Energy-optimal speed control of fans and compressors in a refrigeration system. *Eurotherm 62*, pages 317– 323, 1998.

A. Jakobsen and M. J. Skovrup. Proposal of energy optimal control of condensing pressure, case report from eso project (in danish). 2001.

A. Jakobsen, B. D. Rasmussen, M. J. Skovrup, and J. Fredsted. Development of energy optimal capacity control in refrigeration systems. Purdue, USA, 2001. In proc.: Int. refrigeration conference.

L. F. S. Larsen. *Model based control of refrigeration system*. PhD thesis, Department of Control Engineering, Aalborg University, Denmark, 2005.

L. F. S. Larsen and C. Thybo. Potential energy saving in refrigeration system using optimal setpoint. Taipei, Taiwan, 2004. In proc.: IEEE Conference on control applications.

D. Leducqa, J. Guilparta, and G. Trystramb. Non-linear predictive control of a vapour compression cycle. *Int. J. Refrigeration*, 29:761– 772, 2006.

J. M. Maciejowski. *Predictive control with constraints*. Pearson Education Limited, 2002.

M. C. Swensson. *Studies on on-line optimizing control, with application to a heat pump*. PhD thesis, Department of Refrigeration Engineering, NTNU, Norway, 1994.