

A Simulation Study on Model Predictive Control and Extremum Seeking Control for Heap Bioleaching Processes *

Boris I. Godoy* Julio H. Braslavsky* Juan C. Agüero*

* ARC Centre of Excellence for Complex Dynamic Systems and Control
The University of Newcastle, Callaghan NSW 2308, Australia

Abstract: Heap bioleaching processes are of increasing interest in the mining industry to recover metals from secondary ores. Recently, it has been proposed to use feedback control to improve the rate of mineral extraction. In this paper we compare two feedback approaches, namely Model Predictive Control (MPC) and Extremum Seeking Control (ESC), to improve copper extraction in a heap bioleaching process. Simplified linear models obtained in previous work are used to design an MPC strategy incorporating input constraints. ESC is tuned to maximise copper extraction rate using aeration rate. Simulation results run on a high complexity model of the process show that similar copper extraction rates can be obtained using either strategy. While better control efforts are obtained with MPC, ESC achieves similar results and shows potential for this intrinsically complex process, requiring little knowledge about the plant.

1. INTRODUCTION

This paper proposes and compares two feedback control approaches to improve copper extraction rates in heap bioleaching processes for sulphidic ores. Heap bioleaching is a mining technology based on the dissolution of minerals by a percolating raffinate solution through large piles of crushed ore. Naturally occurring microorganisms, such as *Thiobacillus Ferrooxidans*, can significantly enhance extraction rates in these processes under appropriate conditions of temperature, acidity and humidity of the medium. A flow of air typically blown from the base of the heap is also known to improve copper extraction rates.

As compared to the traditional smelting technology for copper extraction, heap bioleaching offers a number of advantages [Rawlings et al., 2003, Brierley and Brierley, 2001]:

- Heap bioleaching facilities are simpler and more economical to construct and operate.
- Heap bioleaching can operate on low-grade ores that are not economically viable for smelting.
- Heap bioleaching appears as more environmentally friendly than smelting, since it has minimal energy requirements and produces no emissions of hazardous gases such as sulphur dioxide, associated with smelting of sulphidic ores.

An important limitation of the heap bioleaching technology is the slow dynamics of the process, characterised by slow start-ups and lower than expected extraction rates [Watling, 2006, Petersen and Dixon, 2007, Dreisinger, 2006, Lizama, 2004]. Start-up periods are typically of the order of 60 days, after which the extraction of the target mineral is carried out until a pre-determined percentage (typically 80-85 %) of the original estimated mineral in

the heap is reached, which can lapse for 300 to 400 days [Brierley and Brierley, 1999].

Despite important progress on the mathematical modelling aspects of the process in recent years [e.g. Petersen and Dixon, 2003, Leahy et al., 2007], the performance of real commercial facilities has not shown significant improvements, which has been attributed to the complexity of the process and the lack of information about the process in full-scale operation [Lizama, 2004, Watling, 2006]. Setup values for the process parameters, such as aeration rates and raffinate solution composition, are typically chosen empirically [Dixon, 2000], and kept constant for the entire life of the heap.

In Godoy et al. [2007a], the authors propose the implementation of a model-based feedback control strategy to manipulate the bioleaching process parameters during operation to improve extraction performance. To design a basic feedback control law, simplified linear models of the process—valid incrementally around a slowly varying section of the heap nominal response—are estimated using state-of-the-art system identification techniques. Such simple models are used to design a linear control law that yields moderate improvements in extraction rates. These were demonstrated by simulation studies on a black-box high complexity mathematical model of the process developed by BHP Billiton (here referred to as the BHPB model). The main contribution of the work in Godoy et al. [2007a] is to explore and demonstrate the potential of feedback strategies in the operation of a heap bioleaching process. To the authors' best knowledge, no other similar study has been reported in the literature.

The present paper builds on the work in Godoy et al. [2007a] by evaluating and comparing a model-based predictive control (MPC) strategy, a modern standard in process control applications [Camacho and Bordons, 2003, Maciejowsky, 2002], and an extremum seeking control

* This work was supported in part by BHP-Billiton Innovation and the Australian Research Council.

(ESC) strategy, an adaptive technique that has received increased attention in recent years [Ariyur and Krstić, 2003]. ESC has been traditionally applied to systems where there are no models, or existing models are unreliable or difficult to obtain. In recent works, ESC has also been used to find unknown parameters in nonlinear models, where an explicit structure information for the objective function is required [Guay and Zhang, 2003].

For simplicity, we consider heap average temperature and copper extraction as target regulated variables, using raffinate solution rate and aeration flow as manipulated variables. These variables are known key factors in the process dynamics [e.g. Dixon, 2000].

Using the linear models estimated in Godoy et al. [2007a], our simulations on the high complexity model developed by BHP Billiton show that MPC and ESC achieve similar improvements in total copper extraction with respect to that obtained by (open-loop) fixed set-point operation. These improvements are modest, but may be increased by incorporating more detailed process information in the design of MPC and the tuning of ESC. Since ESC can be implemented without recourse of a mathematical model of the process, it thus appears as simpler and potentially more robust alternative for practical implementations.

2. THE PROCESS

Figure 1 illustrates an implementation of a heap bioleaching process. This implementation consists of a large heap (up to several square kilometres in area and 6 to 10 metres in height) of crushed copper mine tailings. A sulphuric acid solution (raffinate) is sprinkled on top of the heap by means of an arrangement of drip lines. As the solution percolates down through the heap, it becomes enriched by the copper dissolved from the heaped ore. The enriched solution (pregnant leach solution, PLS) is then collected at the base of the heap by an impervious liner and pumped to an electro-winning facility, which produces cathodic copper of high purity. The residual solution is recycled to the top of the heap. Naturally occurring microorganisms can act as catalytic agents to the leaching process, significantly increasing the rates of extraction in the process. Heap aeration is also used (typically in sulphidic ores) to enhance the extraction [see Watling, 2006, for more details].

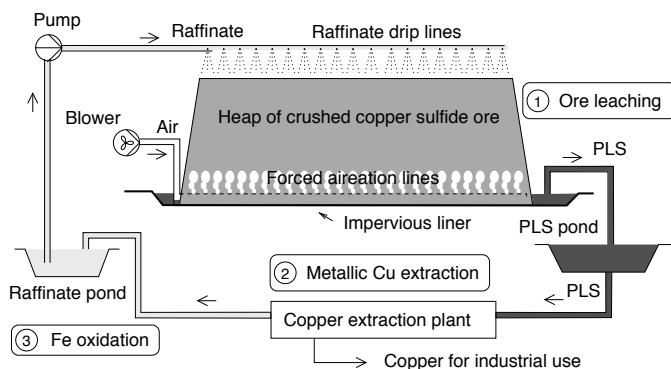

Fig. 1. Simplified copper heap leaching process

Heap temperature is a well recognised factor in the performance of heap bioleaching processes, since it affects the

kinetics of chemical reactions and promotes the mineral-extracting microorganisms that enhance the extraction process [Dixon, 2000, Rawlings et al., 2003, Nemati et al., 1998]. Two macroscopic variables that can be used to drive the average temperature of the heap are the influx rate of raffinate solution, and the aeration rate [Godoy et al., 2007a, Petersen and Dixon, 2007].

In a typical response of a heap bioleaching process to fixed set-point values, the heap undergoes an initial phase of heat development after which a peak in temperature is produced by the dominant action of thermophile microorganisms. A slower varying phase of decreasing biological activity and decreasing temperature follows this peak until heap exhaustion.

In Godoy et al. [2007a], linear maximum likelihood incremental models were estimated around this slow varying section of the nominal temperature response using expectation maximisation methods and data generated with the BHPB model. These models describe with acceptable accuracy small variations of the response around the nominal (fixed set-point) trajectory, and were used to increase the heap average temperature by manipulating raffinate influx and aeration rate in a simple feedback loop. In the present paper we use these models to test and compare implementations of MPC and ESC using the same selection of regulated and manipulated variables.

3. MODEL PREDICTIVE CONTROL

3.1 Overview

In brief, model predictive control is a form of optimal control in which the control action is calculated by solving in real time, at each sampling time, a finite horizon open-loop optimal control problem with the current plant state as initial state. The optimisation yields a sequence of optimal control actions of which only the first control action is applied to the plant. The optimisation is then solved again with the time horizon shifted one sampling time using the updated plant state. The first control action of the optimal sequence is applied, and the procedure is continued in the same way. This is the so called *receding horizon* strategy. See for example Rawlings [2000] for more details.

Following Goodwin et al. [2005], we consider the MPC strategy for a plant assumed stabilisable and detectable and given by discrete-time linear state space equations of the form

$$\begin{aligned} x_{k+1} &= Ax_k + Bu_k \\ y_k &= Cx_k + Du_k + d_k, \end{aligned} \quad (1)$$

where $x_k \in \mathbb{R}^n$, $y_k \in \mathbb{R}^{n_y}$, and $u_k \in \mathbb{R}^{n_u}$ represent the state, the output and the input of the system, and $d_k \in \mathbb{R}^{n_y}$ represents an output disturbance. A minor difference with the approach as presented in Goodwin et al. [2005] is that the plant (1) contains a direct feed forward term, that is, $D \neq 0$, which is convenient for our models.

The optimal control sequence $\{u_0, \dots, u_{M-1}\}$, with *control horizon* $M > 0$, is found to minimise a finite horizon cost function of the form

$$V_{N,M} = \frac{1}{2} \tilde{x}_N^T P \tilde{x}_N + \frac{1}{2} \sum_{k=0}^{N-1} \tilde{x}_k^T C^T Q C \tilde{x}_k + \sum_{k=0}^{N-1} \tilde{u}_k^T D^T Q C \tilde{x}_k + \frac{1}{2} \sum_{k=0}^{N-1} \tilde{u}_k^T D^T Q D \tilde{u}_k + \frac{1}{2} \sum_{k=0}^{M-1} \tilde{u}_k^T R \tilde{u}_k, \quad (2)$$

where N is the *prediction horizon*, $N \geq M$, $e_k = y_k - y_s$ is the error with respect to a set-point y_s , $\tilde{u}_k = u_k - u_s$ is the control effort with respect to a set-point u_s , \tilde{x}_N is the corresponding final state, and $P \geq 0$, $Q \geq 0$ and $R > 0$ are weighting matrices.

With the cost function (2), the optimisation problem can be re-written as [see Godoy et al., 2007b, for details]

$$\min_{\mathbf{u}} V_{N,M} = \frac{1}{2} \mathbf{u}^T H \mathbf{u} + \mathbf{u}^T [F(x_0 - x_s) - G \mathbf{u}_s], \quad (3)$$

where the vectors $\mathbf{u} \in \mathbb{R}^M$ and $\mathbf{u}_s \in \mathbb{R}^{n_u M}$ are defined as

$$\mathbf{u} := [u_0^T \ u_1^T \ \dots \ u_{M-1}^T]^T, \quad \mathbf{u}_s := [u_s^T \ u_s^T \ \dots \ u_s^T]^T, \quad (4)$$

The expressions for the matrices H , F and G can be found in Godoy et al. [2007b].

The unconstrained solution of the minimisation problem in (3) is given by

$$\mathbf{u}^{\text{opt}} := -H^{-1} [F(x_0 - x_s) - G \mathbf{u}_s]. \quad (5)$$

The vector formed by the first M components of (5) has a linear time-invariant feedback structure of the form

$$u^{\text{opt}} = -K(x_0 - x_s) + K_u u_s, \quad (6)$$

where K , K_u are defined as the first M rows of the matrices $H^{-1}F$, $H^{-1}G$, respectively.

3.2 Constraints

Real actuators have a limited range of action and/or a limited slew rate. In chemical processes, the imposition of constraints may be also due to scarcity or cost of resources, aiming at keeping low production costs.

In the case of heap bioleaching process, we aim to improve the process performance by considering constraints on the inputs (control signals), so that they remain close to nominal values previously defined, such as those found through the experience of open-loop operations [Petersen and Dixon, 2007].

Input constraints can be generally written as

$$u_{\min} \leq u_k \leq u_{\max}, \quad k = 0, \dots, M-1, \quad (7)$$

$$\Delta u_{\min} \leq u_k - u_{k-1} \leq \Delta u_{\max}, \quad k = 0, \dots, M-1,$$

where the inequalities are taken component-wise. For $k = 0$, u_{-1} represents the input that is used before the receding horizon implementation is applied.

In a more compact notation, constraints of the form (7) can be represented as as linear constraints on the vector \mathbf{u} [e.g. Goodwin et al., 2005, pp.107],

$$L \mathbf{u} \leq W. \quad (8)$$

The minimisation problem (3) subject to inequality constraints is a *quadratic programming* (QP) problem [Fletcher, 1987], which can be written in the form

$$\min_{\mathbf{u}} \frac{1}{2} [\mathbf{u}^T H \mathbf{u}] + \mathbf{u}^T [F(x_0 - x_s) - G \mathbf{u}_s], \quad (9)$$

subject to: $L \mathbf{u} \leq W$.

The constrained optimal solution is $\mathbf{u}^{\text{opt}}(x)$ in the form

$$\mathbf{u}^{\text{opt}} = \arg \min_{L \mathbf{u} \leq W} \frac{1}{2} [\mathbf{u}^T H \mathbf{u}] + \mathbf{u}^T [F(x_0 - x_s) - G \mathbf{u}_s]. \quad (10)$$

There are standard numerical procedures to solve the QP problem, as for example, *Active Set Methods* and *Interior Point Methods* [Fletcher, 1987]. In conjunction with a receding horizon strategy, the QP problem is solved at every sampling time, which yields a control law in the form

$$u_k = K(x, y_s), \quad (11)$$

where $x_k = x$ is the current value of the state x . The same procedure is done at the next sampling time keeping the same optimisation horizon length.

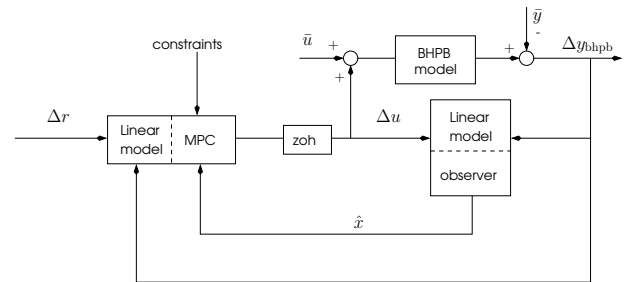

Fig. 2. Closed-loop MPC implementation on the heap bioleaching process

3.3 Application of MPC to the heap bioleaching process

For the application of the MPC strategy to the heap bioleaching process we use a simplified incremental model of the process estimated in Godoy et al. [2007a], as described in Section 2. This linear model is of the form (1) and describes small increments of the average temperature around a nominal trajectory, denoted $\Delta y_k \in \mathbb{R}$, as driven by the a 2×1 input vector with the increments in aeration flow and influx raffinate flow around their nominal set-point values, denoted by $\Delta u_k \in \mathbb{R}^2$.

Figure 2 illustrates the implementation scheme used for the MPC strategy using the incremental linear model. The block “linear model-observer” represents an observer that estimates the states of the incremental model (1) using the input Δu , and Δy_{bhp} , the temperature measurements of the heap—in this case the BHPB model.

The linear model is also used in the block “Linear model-MPC” to obtain predictions of the future outputs of the incremental model, which are used in the MPC algorithm. Constraints and incremental references are implemented in this block, which produces the sequence of incremental control values Δu .

Input aeration is limited to a maximum of $2.2 \text{ [kg/h.m}^2\text{]}$, which is directly implemented via the MPC optimisation algorithm. The response obtained with such incremental feedback control strategy is compared to the nominal (open-loop, constant aeration) response and feedback unconstrained input response in Figure 3. We can observe that, even when aeration is constrained, feedback results yield increased copper extraction.

The time evolution of the second control variable, influx raffinate, is shown in Figure 4. We see that the feedback

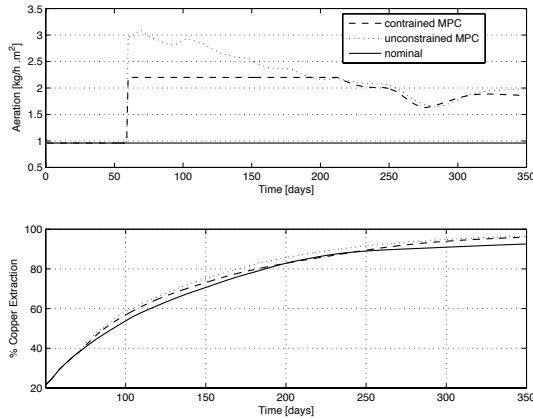

Fig. 3. Aeration rate for a target heap average temperature increase $\Delta r = 12^\circ\text{C}$ (top), and corresponding percentage of copper extraction (bottom) produced by unconstrained and constrained MPC strategies. Also shown: response to nominal (fixed) aeration

strategy produces a reduction in flow to obtain an increase in temperature, which is consistent with previous studies [Dixon, 2000].

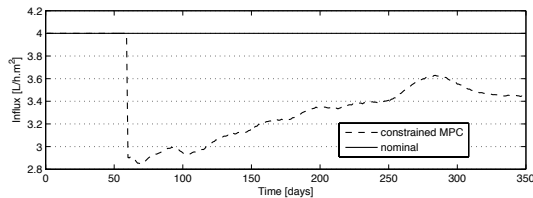

Fig. 4. Influx raffinate for a target heap average temperature increase $\Delta r = 12^\circ\text{C}$. This reduction in irrigation for heat conservation in the heap is consistent with previous studies [Dixon, 2000]

4. EXTREMUM SEEKING CONTROL

4.1 Overview

Extremum Seeking Control (ESC) is an adaptive feedback control strategy that can be applied without the need of a model to an important class of nonlinear control problems [Ariyur and Krstić, 2003]. The goal of this control strategy is to drive an observable system output or objective cost to an optimal extremum value by use of adaptive feedback.

Figure 5 shows a typical discrete-time scheme implementation structure of an ESC strategy. The plant is a stable (or stabilisable) nonlinear system assumed to be represented by state equations of the form

$$\begin{aligned} x_{k+1} &= f(x_k, u_k) \\ y_k &= h(x_k), \end{aligned} \quad (12)$$

where $x_k \in \mathbb{R}^n$ is the state, $u_k \in \mathbb{R}$ is the input, $y_k \in \mathbb{R}$ is the output, and f, h are smooth functions, not necessarily known for the implementation of ESC.

ESC implements a real-time optimisation using the system observed output y_k to estimate and drive the gradient of the objective cost to zero by imposing a probing (oscillatory) behaviour in the system to seek and maintain the optimising input, u^{opt} .

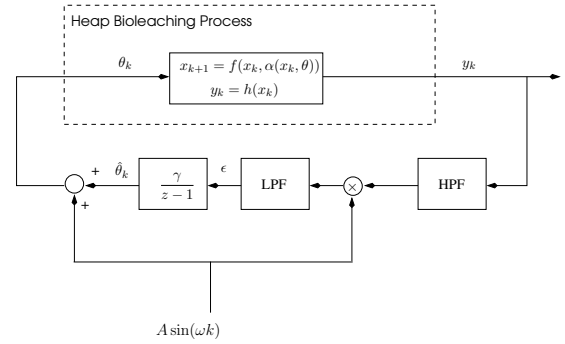

Fig. 5. A general ESC scheme for a discrete-time non-linear system.

One key assumption for the nonlinear system to be controlled by ESC is that it has an extremum in the map between the input u_k and the output y_k [Ariyur and Krstić, 2003, Chapter 5]. If that extremum exists, then an external sustained excitation, $(A \sin \omega_k)$ in Figure 5, is used to find the extremum value of the system output by making the system to oscillate around its operating point. The frequency of such oscillatory behaviour needs to be in a faster time scale than that of the dynamics of the operating point, which thus is gradually driven to its optimal value.

It is worth to notice that the control input u_k may be, in general, a function of the state x_k and a parameter θ_k , as shown in Figure 5. We will consider the simplified case of a control law not directly dependent on the system state, that is, $u_k = \theta_k$. Hence, the closed loop equation for the system (12) is given by

$$x_{k+1} = f(x_k, \theta_k). \quad (13)$$

where θ_k is slowly driving the system operating point.

4.2 Application of ESC to the heap bioleaching process

In the bioleaching process, an extreme in extraction rates arises with respect to aeration. As is known, aeration increases copper extraction Dixon [2000], but an excess of aeration tends to cool down the heap, reducing microbial activity and extraction rates. The existence of such extremum is shown in a sensitivity study performed using the BHPB model and reported in Godoy et al. [2007a].

We implement the ESC strategy to find the value of aeration that maximises concentration of sulphate copper CuSO_4 in the pregnant leaching solution (PLS). We use the scheme shown in Figure 5, and evaluate it by simulations using the BHPB model as the actual plant.

The implementation of ESC requires adequate selection of the exciting input signal, with parameters A and ω , and the cut-off frequency ω_c for the high-pass filter (HPF). The low-pass filter (LPF) is not strictly necessary, and was not used in the present implementation. These parameters are chosen as follows

- Frequency of the exciting signal, ω : the frequency of the exciting signal should be chosen large as compared with the system dynamics. Given that the dynamics of the system with aeration as the input and CuSO_4 concentration as the output is dominated by

a frequency $f_o \approx 1$ [day⁻¹], we choose $\omega \leq 2\pi f_o$, and in particular $\omega = 2$ [rad/day].

- Amplitude of the exciting signal, A : the amplitude of the exciting signal should be chosen small as compared to the nominal value of the output, in order to get small steady state output error. We select it as a 10% of the magnitude order of the output variable, namely, $A = 0.1$.
- Cut-off frequency of the high-pass filter, ω_c : the cut frequency of this filter is chosen as $\omega_c = 0.01\omega$ by trial-and-error. A sensitivity analysis carried out for this parameter shows that it does not have an significant effect on the total copper extraction at the end of the heap life (350 days), as shown in Figure 8 below.
- Gain γ : without loss of generality, this value is chosen $\gamma = 1$.

The results of the simulations are shown in Figures 6 and 7. Figure 6 (top plot) shows the evolution of copper sulfate concentration in PLS with nominal (fixed set-point) and ESC feedback manipulating aeration. The corresponding aeration curve is shown below. Figure 7 shows the corresponding evolution of percentage of copper extracted. An appreciable improvement on the velocity of extraction is seen using ESC. The total extraction rates at the end of the heap life are similar to those obtained with MPC.

Figure 8 shows the effect of different values in the cut-off frequency of the high-pass filter on copper extraction, which is negligible.

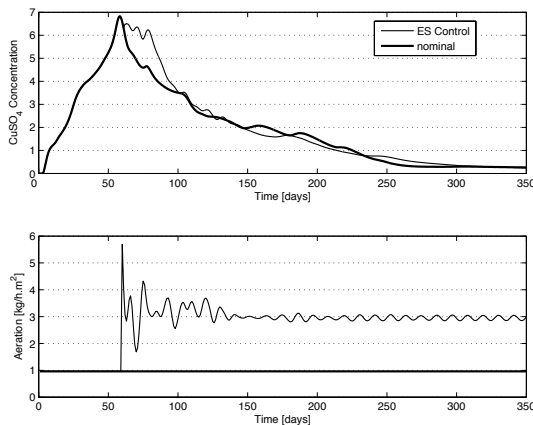

Fig. 6. ESC applied to maximise concentration of [CuSO₄] (top) by manipulating aeration (bottom)

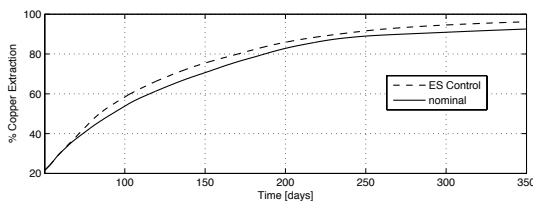

Fig. 7. Total copper extraction [%] for ESC to maximise concentration of [CuSO₄] using aeration

Thus, ESC shows potential to improve copper extraction in the bioleaching process ($\approx 5\%$ of improvement), with

the appropriate tuning of the parameters given in a general ESC scheme. One disadvantage of the ESC strategy is that input constraints are not intrinsically dealt with, which is possible with MPC.

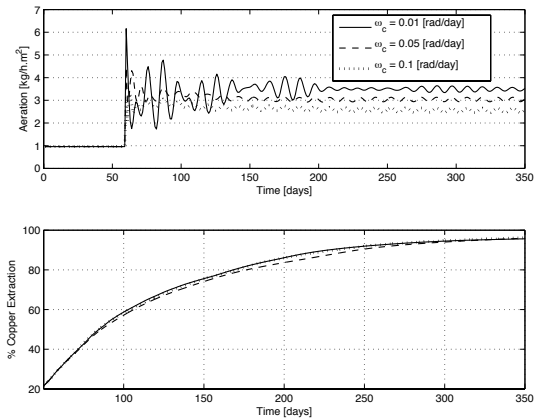

Fig. 8. Sensitivity of the cut-off frequency, for the high-pass filter, on the total copper extraction rate. Aeration (top) corresponds to different values of ω_c . Copper extraction curves (bottom) show that the effect of this parameter is negligible

5. DISCUSSION AND FURTHER WORK

In the present paper we have implemented two feedback strategies to improve copper extraction rates in a heap bioleaching process by manipulating the process set-points in real time using measurements of average temperature and copper concentration in PLS. An MPC design was implemented on a high complexity mathematical model of the process using an incremental linear model fit around a slowly varying phase of the nominal response of the process. We have also tuned and simulated an implementation of ESC that does not require a mathematical model to operate. Both feedback strategies show improvements in copper extraction with respect to the fixed set-point process performance.

The incremental model used in the MPC design describes the relation between the variations of the average temperature in the heap (as the output), and the variations of the influx raffinate and aeration rate (as the inputs). The results show that, for the MPC strategy, the differences of having constraints on one of the inputs has a little effect on the final copper extraction, as shown in Figure 3. However, if the constraints exist, then they can be easily included in the MPC algorithm.

Although ESC was implemented using little knowledge about the process, it provided improvements in extraction comparable to those with MPC, as shown in Figure 7. One disadvantage of the proposed ESC implementation is its inability to deal with constraints, in contrast with MPC. Further work can improve the proposed implementation of ESC by including an anti-windup scheme.

Percentages of copper extraction and aeration curves for MPC and ESC strategies are shown together in Figure 9. The performance improvements with respect to the fixed set-point strategy are noticeable but modest in both cases. For MPC, this may be attributed to the use of simple linear

time-invariant models for the design, which only describe small variations around nominal trajectories. In the case of ESC, we can also say that the tuning procedure was based on simple model assumptions derived from the step-response of the BHPB model.

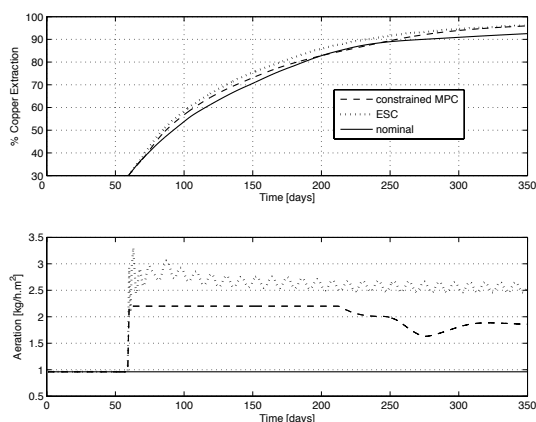

Fig. 9. Comparison of constrained MPC and ESC, with cut-off frequency $\omega_c = 0.1\omega$ for the high-pass filter.

Further work will try and increase the performance improvements obtained by these feedback strategies by incorporating more process information in the design. In particular, a better input-output model of the process could be developed, so that the design of the MPC strategy is not tied to a neighbourhood of a nominal trajectory. One possible modelling approach that would still be amenable to MPC design is nonlinear modelling using Volterra Series. Volterra Series models lead directly to implementations of MPC [Doyle III et al., 2002, Chapter 8].

For the case of ESC, further work will be focused on incorporating more process knowledge in the selection of input variables and the tuning of the parameters of the ESC scheme. With a nonlinear model based on input-output data or on physical principles, we can use the fact that a heap bioleaching process could be interpreted as a continuous-stirred tank reactor and follow ideas given in Wang et al. [1999].

ACKNOWLEDGEMENTS

The authors are indebted to John Truelove from BHP-Billiton Innovation, for useful advice and for granting access to the BHPB model.

REFERENCES

K.B. Ariyur and M. Krstić. *Real-Time optimization by Extremum Seeking Control*. Wiley-Interscience, 2003.
 C.L. Brierley and J.A. Brierley. *Bioheap Processess: Operational requirements and techniques*, chapter 2: Copper Leaching, Solvent Extraction, and Electrowinning Technology. Society for Mining, Metallurgy, and Exploration Inc., 1999.
 J.A. Brierley and C.L. Brierley. Present and future commercial applications of biohydrometallurgy. *Hydrometallurgy*, 59(5):233–239, 2001.
 E.F. Camacho and C. Bordons. *Model Predictive Control*. Springer, second edition, 2003.

D.G. Dixon. Analysis of heat conservation during copper sulphide heap leaching. *Journal of Hydrometallurgy*, 58(84):27–41, 2000.
 F. J. Doyle III, R. K. Pearson, and B. A. Ogunnaike. *Identification and Control Using Volterra Models*. Springer, 2002.
 D. Dreisinger. Copper leaching from primary sulfides: Options for biological and chemical extraction copper. *Hydrometallurgy*, 83(5):10–20, 2006.
 R. Fletcher. *Practical Methods of Optimization*. John Wiley and Sons, second edition, 1987.
 B.I. Godoy, J.H. Braslavsky, and J.C. Agüero. A model-based feedback control strategy for heap bioleaching processes. In *46th IEEE Conference on Decision and Control*, New Orleans, LA, USA, 2007a.
 B.I. Godoy, J.H. Braslavsky, and J.C. Agüero. Model predictive control applied to heap bioleaching processes. Technical Report EE07015, School of EE&CS, The University of Newcastle, 2007b. <ftp://warhol.newcastle.edu.au/pub/Reports/>.
 G.C. Goodwin, M.M. Seron, and J.A. De Dona. *Constrained Control and Estimation: An optimisation approach*. Springer, 2005.
 M. Guay and T. Zhang. Adaptive extremum seeking control of nonlinear dynamic systems with parametric uncertainties. *Automatica*, 39(7):1283–1293, 2003.
 M.J. Leahy, M.R. Davidson, and M.P. Schwarz. A model for heap bioleaching of chalcocite with heat balance: Mesophiles and moderate thermophiles. *Hydrometallurgy*, 85(5):24–41, 2007.
 H.M. Lizama. Copper bioleaching behaviour in an aerated heap. *International Journal of Mineral Processing*, 14(4):717–728, 2004.
 J.M. Maciejowsky. *Predictive Control with Constraints*. Prentice - Hall, second edition, 2002.
 M. Nemati, S.T.L. Harrison, G.S. Hansford, and C. Webb. Biological oxidation of ferrous sulphate by thiobacillus ferrooxidans: a review on the kinetic aspects. *Biochemical Engineering Journal*, 1(4):171–190, 1998.
 J. Petersen and D.G. Dixon. A modelling study of the dynamics of sulphide heap leach processes with a view to improved and novel applications. In *23th International Mineral Processing Congress*, Cape Town, South Africa, October 2003.
 J. Petersen and D.G. Dixon. Principles, mechanisms and dynamics of chalcocite heap bioleaching. In E.R. Donati and W. Sand, editors, *Microbial Processing of Metal Sulfides*, chapter 10. Springer-Verlag, 2007.
 D.E. Rawlings, D. Dew, and C. Du Plessis. Biomineralization of metal-containing ores and concentrates. *Trends in Biotechnology*, 21(1):38–44, 2003.
 J. B. Rawlings. Tutorial overview of model predictive control. *IEEE Control Systems Magazine*, 20(3):38–52, 2000.
 H.H. Wang, M. Krstic, and G. Bastin. Optimizing bioreactors by extremum seeking. *International Journal of Adaptive Control and Signal Processing*, 13(8):651–669, 1999.
 H.R. Watling. The bioleaching of sulphide minerals with emphasis on copper sulphides - a review. *Hydrometallurgy*, 84(5):81–108, 2006.