

## DEBUGGING STATIC AND DYNAMIC RIGOROUS MODELS FOR EQUATION-ORIENTED CAPE TOOLS

R. P. Soares \* A. R. Secchi \*

\* *Departamento de Engenharia Química - UFRGS*  
*Rua Eng. Luis Englert, s/n, CEP 90040-040 - Brasil*  
*E-mail: {rafael, arge}@eng.ufrgs.br*

Abstract: In the field of process simulation, a movement from modular oriented, which is currently the most widely used technique, to Equation-Oriented (EO) is clear. One of the key advantages of the EO approach is that the effort spent in model development is minimized by reusing the models in several different tasks, for instance: model linearization, simulation, optimization, and data reconciliation. EO tools support the implementation of models to a large extent, however there is almost no assistance in the model development process. In this work the currently available methods for detecting inconsistencies in systems of equations coming from both static and dynamic models are briefly reviewed. For the dynamic case a new algorithm is proposed. This algorithm is scalable for large problems and is a promising diagnosis tool to spread the usage of EO dynamic simulators. Finally, applications in test cases are used to illustrate the debugging techniques.  
*Copyright © 2007 IFAC*

Keywords: Dynamic modelling, Debugging, Graph theory

### 1. INTRODUCTION

The current process simulators may roughly be classified into two groups: modular and equation-oriented (Boston et al., 1993).

In modular tools the models of process units are precoded in a programming language by a modelling expert and incorporated in a model library. The end user selects the models from the library and connects them to form the plant model. The incorporated chemical engineering knowledge as well as the model structure are largely fixed and not accessible (Marquardt, 1996).

In equation-oriented (EO) or equation-based implementations the equipment models are written in some descriptive or *modelling* language and usually are opened for inspection and extension. These models share with the plant model their

equations and not only their numerical solution. As a consequence, the implementation of unit models is independent of any particular application or algorithm that may be used for their solution. Due these reasons, the EO technology has been demonstrated as effective in application to a wide range of problems as model linearization, simulation, parameter estimation, and data reconciliation all using a single set of models (Allan, 1997). Recognition of potential benefits of EO technology has led to the development of several tools (Rico-Ramirez, 1998). Examples of implementations are SpeedUp (Pantelides, 1988b), gPROMS (Oh and Pantelides, 1996), ASCEND (Allan, 1997), ABACUS II (Tolsma et al., 1999), and EMSO (Soares and Secchi, 2003).

On the other hand, EO unit models do not carry any information about the valid set of specifi-

cations or initial conditions. The user needs to have at least a minimal knowledge of the model internals in order to estimate which variables can be fixed to close the degrees of freedom. Further, the user needs to know not only which variables can or cannot be fixed but if a given set of variables is valid because some variables cannot be fixed at the same time. For dynamic models the situation can be even worst because the same problems appear for the initial conditions. From the end user perspective, these aspects makes EO simulators harder to use. Actually, modelling has been the bottleneck to the widespread use of EO tools in the industrial practice and not numerical algorithms. Another problem is that the unit operation library developer has almost no assistance in fixing problematic models.

In this work, methods for diagnosing ill-posed models coming from EO tools are reviewed and extended. Making an analogy with software development, the methods which aid to detect and remove problems of the models are called *debugging*. Basically, the objective is to remove some of the deficiencies of the EO technology by answering the following questions:

- For an under-constrained model which variables can be fixed or specified?
- For an over-constrained model which equations should be removed?
- For dynamic simulations, which variables can be supplied as initial conditions?
- How to report the inconsistencies making it easy to fix?

In other words, debugging methods need to go beyond degrees of freedom and index analysis.

## 2. NONLINEAR SYSTEMS

A general system of nonlinear algebraic (NLA) equations can be represented by:

$$F(y) = 0 \quad (1)$$

where  $F$  is the function vector and  $y$  are the variables. System (1) has  $m$  equations in terms of  $n$  variables and appears in the solution of steady-state simulations of EO simulators. If all equations are linear, the system (1) can be reduced to:

$$Ay = b \quad (2)$$

The solution of (1) can be obtained using a Newton-like method. Such methods iteratively solve problems like (2), where  $A$  is some approximation of the Jacobian  $F_y$ . This means that  $F_y$  needs to be invertible along the solution path.

Most codes for matrix inversion are able to detect numerical singularities before failing. Some more robust codes can check if the matrix is structurally singular before actually try to solve the problem, *e.g.* Amestoy et al. (2004). However, these codes cannot be used to diagnose the source of the problem because they stop the analysis when the singularity is detected. In the following sections, currently available methods, based on graph theory, capable to detect and report the source of structural singularities for NLA systems are briefly reviewed.

### 2.1 Graph Theory Basics

A *graph* consists in a pair  $G = (V, E)$  of sets satisfying  $E \subseteq [V]^2$ . Thus the elements of  $E$  are pairs of the elements of  $V$ . The elements of  $V$  are the *vertices* (or *nodes*, or *points*) of the graph  $G$ , and the elements of  $E$  are its *edges* (or *lines*).

In Fig. 1 a typical graph is drawn. How the nodes and edges are drawn is considered irrelevant: all that matters is the information about which pairs of vertices form an edge and which do not. A good source for graph theory concepts is the book due to Diestel (2000).

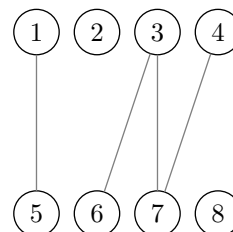

Fig. 1. The graph on  $V = \{1 \dots 8\}$  with edge set  $E = \{\{1, 5\}, \{3, 6\}, \{3, 7\}, \{4, 7\}\}$ .

### 2.2 NLA Systems as Graphs

When analyzing a system of equations the equation-variable relationship is very important. For this combinatorial problem the concept of bipartite graphs can be used. A graph  $G = (V = V_e \cup V_v, E)$  is called *bipartite* if  $V$  admits a partition in two classes such that every edge has its ends in different classes. In this work, the partition classes are called  $V_e$  (equation nodes) and  $V_v$  (variable nodes).

Using this notation the NLA system of equations (3) can be drawn as the bipartite graph shown in Fig. 2 (Bunus, 2002).

$$\begin{aligned}
f_1(x_1) &= 0 \\
f_2(x_1, x_2) &= 0 \\
f_3(x_1, x_2) &= 0 \\
f_4(x_2, x_3, x_4) &= 0 \\
f_5(x_4, x_5) &= 0 \\
f_6(x_3, x_4, x_5) &= 0 \\
f_7(x_5, x_6, x_7) &= 0
\end{aligned} \tag{3}$$

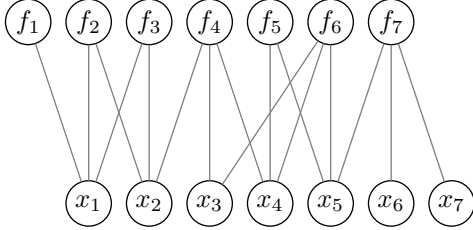

Fig. 2. Graph for the NLA system (3).

As can be seen in Fig. 2 the values or form of the equations in (3) are irrelevant, only the equation-variable relationship is considered. This is the essence of the structural analysis.

### 2.3 Debugging NLA Systems

When checking for problems in NLA systems the first check should be a degrees of freedom analysis. But systems with zero degrees of freedom still can be inconsistent, as in the case of system (3).

The structural singularity of a NLA system can be easily checked using a maximum matching algorithm (Saip and Lucchesi, 1993). One maximum matching association for system (3) can be seen in Fig. 3. In this figure, the edges which are part of the matching are shown in *bold* and nodes not covered by the association are *marked*.

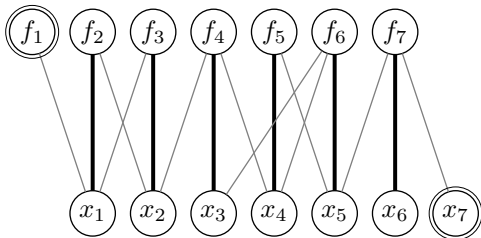

Fig. 3. Maximum matching for system (3).

If a maximum matching association includes all variables and all equations (a perfect matching) then the system is structurally non-singular. Otherwise the system is structurally singular and any trial to numerically solve the system will fail.

On the other hand, the maximum matching checking cannot be used as a tool for fixing the problem because the source of the problem is still obscured. One step further can be achieved using the DM decomposition (Dulmage and Mendelsohn, 1958).

This method canonically decomposes any maximum matching of a bipartite graph into three distinct parts: over-constrained, under-constrained, and well-constrained. The application of the DM decomposition to the graph shown in Fig. 3 produces Fig. 4.

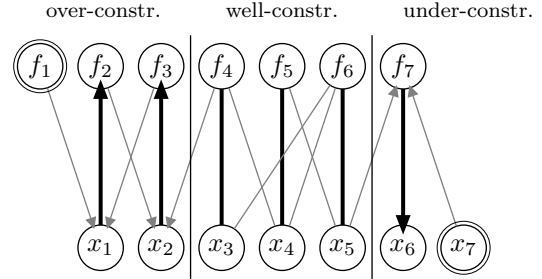

Fig. 4. DM decomposition for system (3).

From Fig. 4 a debugging tool can conclude that one of the equations  $\{f_1, f_2, f_3\}$  needs to be removed and one additional equation involving  $x_6$  or  $x_7$  needs to be added. From the end user perspective of an EO tool, one conclusion could be:  $x_7$  should be specified and  $f_1$  should be removed or used to evaluate a wrongly specified variable.

## 3. DIFFERENTIAL-ALGEBRAIC SYSTEMS

Differential-Algebraic Equation (DAE) systems arise naturally when dealing with dynamic simulation in EO tools. A general DAE system can be represented by:

$$F(t, y, y') = 0 \tag{4}$$

where  $t$  is the time and  $y'$  are the derivatives of  $y$  with respect to  $t$ .

The *index* of DAE systems is of great importance in the numerical classification of a DAE system (Brenan et al., 1989). Historically the analysis of this kind of problem was limited to degrees of freedom and index analysis (see Duff and Gear, 1986; Pantelides, 1988a; Bachmann et al., 1990; Unger et al., 1995).

Today, the algorithm developed by Pantelides (1988a) is the most widely used structural technique for analysis of DAE problems. The main objective of that work was to determine the number of initial conditions required for consistent initialization, in other words, to check the number of *dynamic* degrees of freedom. Unfortunately, the DM decomposition cannot be applied to the Pantelides' algorithm resulting graph.

In this work a new algorithm for the analysis of DAE systems is introduced. This algorithm is very similar to the algorithm proposed by Pantelides (1988a) but its resulting graph is suitable for a DM decomposition.

### 3.1 New DAE Analysis Algorithm

DAE systems also can be represented as bipartite graphs. But in the dynamic case there are two new concepts: the derivatives of the variables are also considered and the equations can be differentiated inserting new elements into the graph. In order to illustrate these concepts, consider the following system of equations:

$$\begin{aligned} f_1(x'_1, x'_2) &= 0 \\ f_2(x_2) &= 0 \end{aligned} \quad (5)$$

where  $x'_1$  and  $x'_2$  are the time derivatives of the variables  $x_1$  and  $x_2$ .

Fig. 5 shows the graph representation for the system (5), but with the second equation differentiated with respect to time. As can be seen in this figure, the variables are classified as algebraic (in *gray*) and differential (in *black*). It should be noted that, although  $x_1$  does not appear in system (5), it is considered on the graph. Further, it is considered that the time derivative of  $f_2$  involve only  $x'_2$  and not  $x_2$  (structural differentiation).

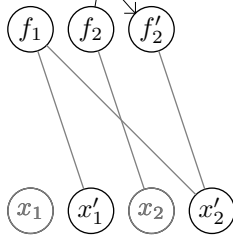

Fig. 5. Graph for system (5) with the second equation differentiated.

In this work the Algorithm 1 is proposed for the analysis of DAE systems. This algorithm expects as input a graph  $G$  representing the system of equations and returns a new graph (with possibly more equations and variables) and its maximum matching  $M$ .

---

**Algorithm 1** Pseudocode for the new DAE analysis algorithm for a given graph  $G(V_e, V_v, E)$ .

---

```

input  $G(V_e, V_v, E)$  output:  $G, M$ 
1:  $M \leftarrow \emptyset$ 
2: for  $v_e \in V_e$  do
3:   if not  $Match(G, M, v_e, \mathbf{false})$  then
4:     mark all colored  $v_k \in V_e$ 
5:     uncolour all  $v_e$ 
6:     if not  $Match(G, M, v_e, \mathbf{true})$  then
7:       return false
8:     end if
9:     diff all marked  $v_k \in V_e$ 
10:  end if
11: end for
12: return true

```

---

Basically, the algorithm will loop for all equations (line 2) trying to find a match for it (line 3), but

**ignoring** the algebraic variables. If such match is not possible it tries to find a match considering **all** variables (line 6). If the match including all variables is not possible then the system is structurally singular.

The *Match* algorithm (upon which the Algorithm 1 is based) tries to augment the current match  $M$  by including a new matching for the given equation node  $v_e$ .

If the last argument of *Match* is *false*, then it ignores the **algebraic** variables, otherwise **all** variables are considered (lines 3 and 6 of Algorithm 1, respectively). If the matching was augmented by *Match* it returns *true*, otherwise it fails returning *false*. Unfortunately, there is no room for a formal presentation of the *Match* algorithm.

When *Match* fails, the subset of the equations  $V_e$  reached by alternating paths starting at  $v_e$  is colored. When this happens in line 3 of Algorithm 1, all *colored* equations are *marked*. Equations *marked* at that step are structurally differentiated with respect to time in line 9. When equations are differentiated, new equations are added to the system and possibly new variables.

In order to clarify the application of the Algorithm 1, consider again the system of equations (5) and its graph in Fig. 5. For the first equation  $f_1$ , the line 3 will find the match  $\{f_1 - x'_1\}$ . For  $f_2$ , the line 3 will fail (there is no possible match when the algebraic variables are ignored). As a consequence,  $f_2$  will be marked at line 4. In line 6 (when **all** variables are considered), the match  $\{f_2 - x_2\}$  is found. Fig. 6 shows the graph and matching at this point.

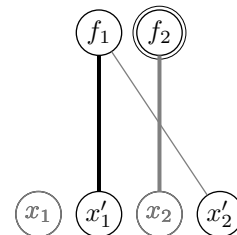

Fig. 6. Graph for system (5) after the first three steps of the algorithm.

At line 9 the new equation  $f'_2$  will be added. Finally the match  $\{f'_2 - x'_2\}$  if found at line 3 and the algorithm finishes. The final matching can be seen in Fig. 7

The main advantage of the new algorithm is that its final association is suitable for a DM decomposition. For instance, the under-constrained partition will reveal all variables which can be supplied as initial conditions. Taking the system (5), the under-constrained partition will include only  $x_1$ . Using this information, an EO tool can tell to the end user that the only option for this model

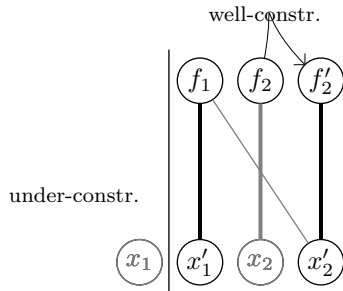

Fig. 7. Graph for system (5) after the analysis.

is to supply an initial value for  $x_1$ . All other variables  $\{x'_1, x_2, x'_2\}$  are discarded from the initial conditions candidates.

It should be noted that the differentiations executed by the algorithm are only structural. This kind of differentiation can be implemented very efficiently and do not depend on the actual form of the equations.

The proposed algorithm can be applied without modifications to analyze high-index DAE systems. The equations differentiated by the algorithm can also be used to generate an index-reduced system, but index reduction is out of the scope of this paper.

#### 4. REAL APPLICATIONS

In the previous sections very simple examples were used to illustrate the presented algorithms. In this section it is presented how the debugging techniques scale for larger and more complex problems.

##### 4.1 Computation Time

In order to check how the new algorithm for DAE analysis performs for large scale problems a dynamic model for distillation processes was analyzed. This model has mass and energy balances for each tray besides thermodynamics and hydrodynamics equations.

For the case of the separation of isobutane from a mixture of 13 compounds in a 40-tray column the number of variables is almost 4,000. The computational time required to analyze the dynamic model of this system with different numbers of trays can be seen in Table 1.

Table 1. Time to analyze the dynamic model of a distillation column varying the number of trays.

Trays	Variables	Time (s)	Time / $N^2$ (s · 10 <sup>9</sup> )
20	2157	0.04	9.46
40	3877	0.14	9.58
80	7317	0.52	9.79

The results shown in Table 1 were obtained in a Pentium M 1.70 GHz PC with 2 Mb of cache

memory running Ubuntu Linux version 6.06. All analyzed cases are well-posed models - this test was not used to test the debugging power of the algorithm. As can be seen in the table, the performance is approximately quadratic bounded as are the majority of the solution methods.

Another good result is that the time required by the analysis is very acceptable for user interaction. With the current available hardware, this time is of the order of one second for systems with 10,000 variables. Moreover, the algorithm can be applied incrementally adding new equations and variables as the user interacts with the modelling environment. This fact can brake-up the analysis time, making the software more responsive to the end user.

##### 4.2 Debugging Power

The algorithms presented in the previous sections can be used to discover problems in systems of equations. In order to show how unstable these algorithms can be regarding the system being analyzed, consider the ammonia synthesis process as shown in Fig. 8 (Biegler et al., 1997).

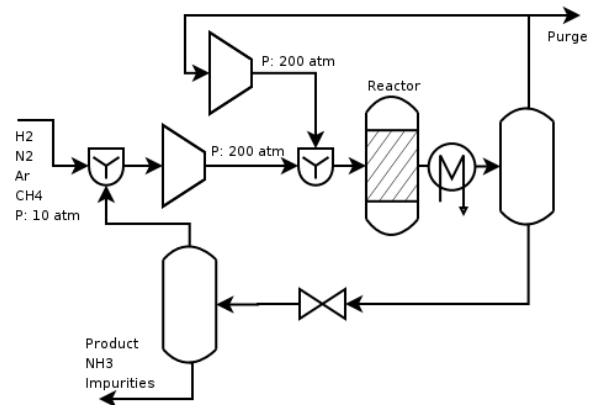

Fig. 8. Ammonia synthesis process.

A static model with 134 variables for the process in Fig. 8 was constructed. If all specifications are supplied correctly the maximum matching algorithm finishes with a perfect matching. But if one specification is missing, for instance the process feed flow rate, then the under-constrained partition will involve 96 variables. This means that the well-constrained partition covers only about 30% of the variables.

Unfortunately the majority of the models have a similar behavior: in the case of a singularity the number of fixing options is quite large. No doubt this is a weak point of the presented debugging techniques. In order to reduce this deficiency the fixing options could be ranked by heuristic rules that present the more meaningful options first. These rules are currently being developed.

## 5. CONCLUSIONS

In this work, techniques which aid in the location and removal of inconsistencies of the models coming from Equation-Oriented simulators were called debugging methods. For static models (NLA systems) mature methods were found in the literature and briefly reviewed.

For the dynamic case (DAE systems) a very less mature situation is found. Historically, the analysis of such systems was limited to degrees of freedom and index analysis. A new algorithm for structural analysis of DAE systems was proposed. The key advantage of this algorithm is that it can be used for debugging purposes. This brings the analysis of DAE systems to the same level as NLA systems.

All methods presented in this work were implemented in C++ and are freely available from the author. The major deficiency of the presented methods is the large number of fixing options when a singular model is found. In order to reduce this deficiency, heuristic rules for ranking the fixing options are being studied. Furthermore, these codes are being incorporated in the EMSO (Soares and Secchi, 2003) process simulator.

## REFERENCES

- B. A. Allan. *A More Reusable Modeling System*. PhD thesis, Department of Chemical Engineering, Carnegie Mellon University, Pittsburgh, PA, USA, 1997.
- Patrick Amestoy, Enseiht-Irit, Timothy A. Davis, and Iain S. Duff. Algorithm 837: Amd, an approximate minimum degree ordering algorithm. *ACM Trans. Math. Softw.*, 30(3):381–388, 2004.
- R. Bachmann, L. Brüll, T. Mrziglod, and U. Pallaske. On methods for reducing the index of differential algebraic equations. *Computers & Chemical Engineering*, 14(11):1271–1273, 1990.
- L. T. Biegler, I. E. Grossmann, and A. W. Westerberg. *Systematic Methods of Chemical Process Design*. Prentice Hall International Series in Physical and Chemical Engineering Sciences, 1997.
- J. F. Boston, H. I. Britt, and M. T. Tayyabkhan. Tackling tougher tasks. *Chemical engineering progress*, 89(11):38–49, 1993.
- K. E. Brenan, S. L. Campbell, and L. R. Petzold. *Numerical Solution of Initial-Value Problem in Differential-Algebraic Equations*. North-Holland, New York, 1989.
- Peter Bunus. *Debugging and Structural Analysis of Declarative Equation-Based Languages*. PhD thesis, Department of Computer and Information, Science Linkpings Universitet, Linkping, Sweden, 2002.
- Reinhard Diestel. *Graph theory*. Springer-Verlag, New York, 2 edition, 2000. URL <http://www.math.uni-hamburg.de/home/diestel/books/graph.theory/GraphTheoryII.pdf>.
- I. S. Duff and C. W. Gear. Computing the structural index. *SIAM Journal on Algebraic and Discrete Methods*, 7(4):594–603, 1986.
- A. L. Dulmage and N. S. Mendelsohn. Coverings of bipartite graphs. *Canad. J. Math.*, (10):517–534, 1958.
- W. Marquardt. Trends in computer-aided process modeling. *Computers & Chemical Engineering*, 20(6):591–609, 1996.
- M. Oh and C. C. Pantelides. A modelling and simulation language for combined lumped and distributed parameter systems. *Computers & Chemical Engineering*, 20:611–633, 1996.
- C. C. Pantelides. The consistent initialization of differential-algebraic systems. *SIAM J. Sci. Stat. Comp.*, 9(2):213–231, March 1988a.
- C. C. Pantelides. Speedup-recent advances in process simulation. *Computers & Chemical Engineering*, 12(7):745–755, 1988b.
- Vicente Rico-Ramirez. *Representation, analysis And Solution Of Conditional Models In An Equation-Based Environment*. PhD thesis, Department of Chemical Engineering, Carnegie Mellon University, Pittsburgh, PA, USA, 1998.
- H. Saip and C. Lucchesi. Matching algorithms for bipartite graph. Technical Report DCC-03/93, Departamento de Cincia da Computao, Universidade Estadual de Campinas, Campinas, Brazil, 1993. URL <http://citeseer.ist.psu.edu/baiersaip93matching.html>.
- R. P. Soares and A. R. Secchi. EMSO: A new environment for modelling, simulation, and optimisation. In *ESCAPE 13th*, volume 1, pages 947–952. Elsevier Science Publishers, 2003.
- J. E. Tolsma, J. Clabaugh, and P. I. Barton. ABACUSS II: Advanced modeling environment and embedded simulator, 1999. URL <http://yoric.mit.edu/abacuss2/abacuss2.html>.
- J. Unger, A. Kroner, and W. Marquardt. Structural analysis of differential-algebraic equation systems—theory and applications. *Computers & Chemical Engineering*, 19(8):867–882, August 1995.