

We are IntechOpen, the world's leading publisher of Open Access books Built by scientists, for scientists

3,900

Open access books available

116,000

International authors and editors

120M

Downloads

Our authors are among the

154

Countries delivered to

TOP 1%

most cited scientists

12.2%

Contributors from top 500 universities



WEB OF SCIENCE™

Selection of our books indexed in the Book Citation Index
in Web of Science™ Core Collection (BKCI)

Interested in publishing with us?
Contact book.department@intechopen.com

Numbers displayed above are based on latest data collected.
For more information visit www.intechopen.com



Water Quality Modeling and Control in Recirculating Aquaculture Systems

Marian Barbu, Emil Ceangă and Sergiu Caraman

Additional information is available at the end of the chapter

<http://dx.doi.org/10.5772/62302>

Abstract

Nowadays, modern aquaculture technologies are made in recirculating systems, which require the use of high-performance methods for the recirculated water treatment. The present chapter presents the results obtained by the authors in the field of modeling and control of wastewater treatment processes from intensive aquaculture systems. All the results were obtained on a pilot plant built for the fish intensive growth in recirculating regime located in "Dunarea de Jos" University from Galati. The pilot plant was designed to study the development of various fish species, starting with the less demanding species (e.g. carp, waller), or "difficult" species such as trout and sturgeons (beluga, sevruga, etc.).

Keywords: Recirculating aquaculture system, Modeling and control, Water quality, Trickling biofilter, Expert system

1. Introduction

The recirculating aquaculture systems (RASs) became an essential component of the modern aquaculture [1–3]. The accelerated developing of RASs, which tend to become predominant with respect to the "flow-through" systems from the classic fishpond aquaculture, was stimulated by the necessity to locate the production units close to the markets, i.e. in the areas with high population density.

Thus, RASs became an important component of the *Urban Agriculture*. But the close proximity of the production centers by the sale units is just one of the advantages of RASs. Among other advantages of RASs, some even more important than the mentioned one, are the following:

- the possibility to control physicochemical parameters of the culture medium: dissolved oxygen concentration of the water, concentrations of the harmful substances (ammonia, nitrites, nitrates, carbon dioxide etc.), pH, temperature etc.;
- saving water resources. In the classical “flow-through” systems, the specific water consumption is about 10 (m³ water/kg of fish), whereas in RASs only 5–10% of the total volume of the recirculated water is replaced with fresh water, resulting a consumption of about 0.1 (m³ water/kg of fish);
- the possibility to control the hygienic and sanitary state of the culture biomass by removing the possibility of pathogens penetration inside RAS, applying preventive measures for diseases, the prompt achievement of the treatments when the diseases occur etc.
- providing a performant technological management concerning the populating of aquaculture tanks (i.e. populating density) for different ages of the fish biomass, implementing the feeding technology; and
- reduce the negative impact on the environment through specific means of collecting the residual solids and respecting the requirements concerning the water exhausted from RASs and discharged in the collecting urban network.

Besides the advantages mentioned above, RASs also have some drawbacks, the most important being the required investments for the equipment. Some of these — such as those for monitoring and control — are expensive. Relatively high electricity consumption to provide the water recirculating in an aquaculture system could also be mentioned.

The biological filtering process of the recirculated water has a crucial importance in RAS technology. The degree of RAS intensity, which means the ratio (fish production/space unit of culture) to provide a correct hygienic and sanitary state of the fish biomass, depends on the performance of this process. Therefore, the issue of modeling the biological filtering process is treated in this chapter with priority.

In the fish intensive growth tanks, an aerobic process takes place. The organic substances existing in the water (dejections, unconsumed food) are decomposed by heterotrophic bacteria in simpler organic products, resulting ammonia as a final product. The ammonia is also a metabolism product of fish, being released mainly by gills. However, the amount of ammonia from an aquaculture tank mostly depends on the food rate of the fish biomass. In the aquaculture tanks, the ammonia is found in two forms: the ionized form and the unionized one. The unionized ammonia is extremely toxic for the fish, and its concentration depends on the water pH and temperature.

The ammonia removal takes place through a biological filtering process that develops in two phases: (1) ammonia is oxidized by *Nitrosomonas* bacteria and transformed in nitrites, which are highly toxic and (2) the nitrites are oxidized by another category of autotrophic bacteria (*Nitrobacter*) and transformed into nitrates. The two oxidizing processes should be followed by a denitrification process, which leads to the conversion of nitrates into gaseous nitrogen. Denitrification can be achieved by either chemical or biological means. The second possibility consists in using of aquatic plants for which the nitrate is a food source enabling to achieve an

aquaponic system. This is a recirculating system that provides simultaneously the fish and plant growth (usually vegetables) using a single input: fish fodders. The fish component of the aquaponic recirculating system provides the food (nitrate) for the horticultural biomass and the plants contribute through denitrification to the recirculated water purity in aquaculture tanks.

The next sections briefly present some results regarding the modeling and control of a pilot plant from “Dunarea de Jos” University of Galati consisting in a RAS with a chemical denitrifier. The next section describes the pilot plant including the technological and control equipment. Section 3 presents the mathematical model of RAS, focusing on the biological filtering processes. Some experimental results concerning the control of RAS and the possibilities of using expert systems in this purpose are included in Sections 4 and 5, respectively. The work ends with a brief section of conclusions.

2. The experimental plant

The experimental plant is located in the Intensive Aquaculture Laboratory at “Dunarea de Jos” University of Galati, Romania. It consists of two subsystems: the technological equipment and the one for monitoring and control purpose.

2.1. The technological equipment

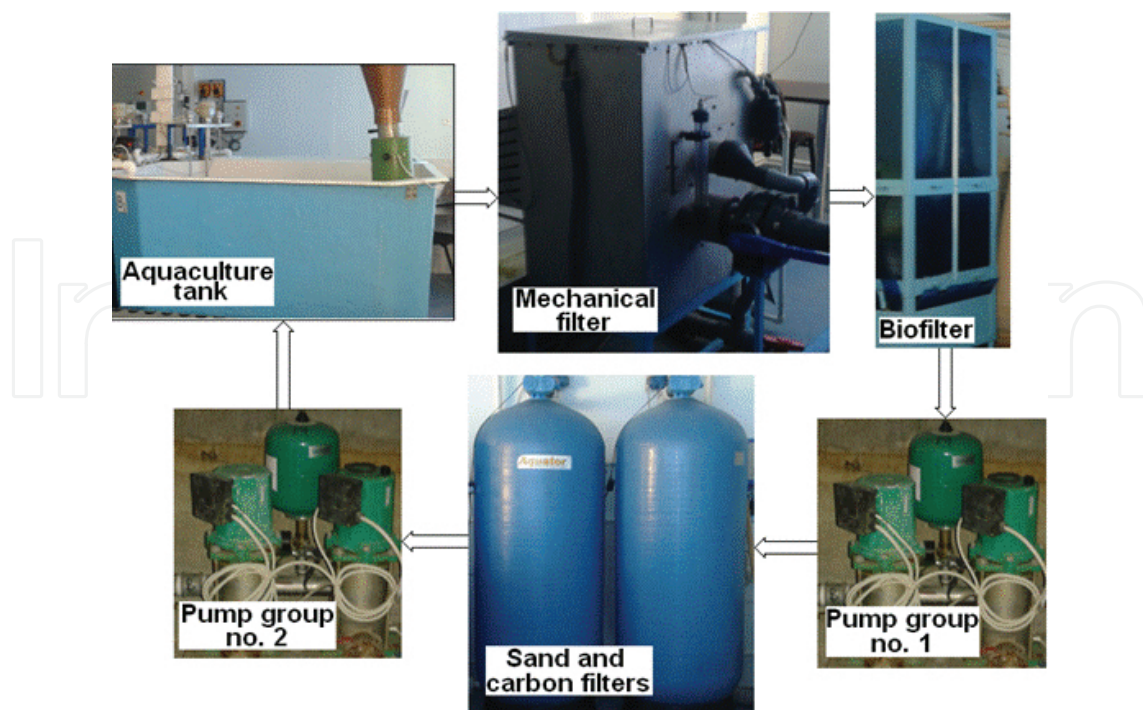

Figure 1. Structure of the technological plant.

Figure 1 shows the technological plant. It contains the following components: four aquaculture tanks of 1 m³ each, a drum filter for rough solids removal, a collecting tank, a sand filter and an activated carbon filter for the removal of fine solids in suspension, a biological filter of trickling type together with a second collecting tank, a denitrificator that retains the nitrates, an UV filter, that acts as a disinfectant for killing the pathogenic bacteria, and the feed dosing mechanism. The aquaculture plant is also provided with an air supplying system aiming to ensure the necessary dissolved oxygen concentration in the fish tanks and in the biofilter.

2.2. Monitoring and control equipment

Figure 2 shows the monitoring and control system of RAS. It contains two control levels: the first level includes the basic control loops together with the data acquisition system; the second level has two components: an expert system for diagnosis and global control of RAS and the Human–Machine Interface (HMI).

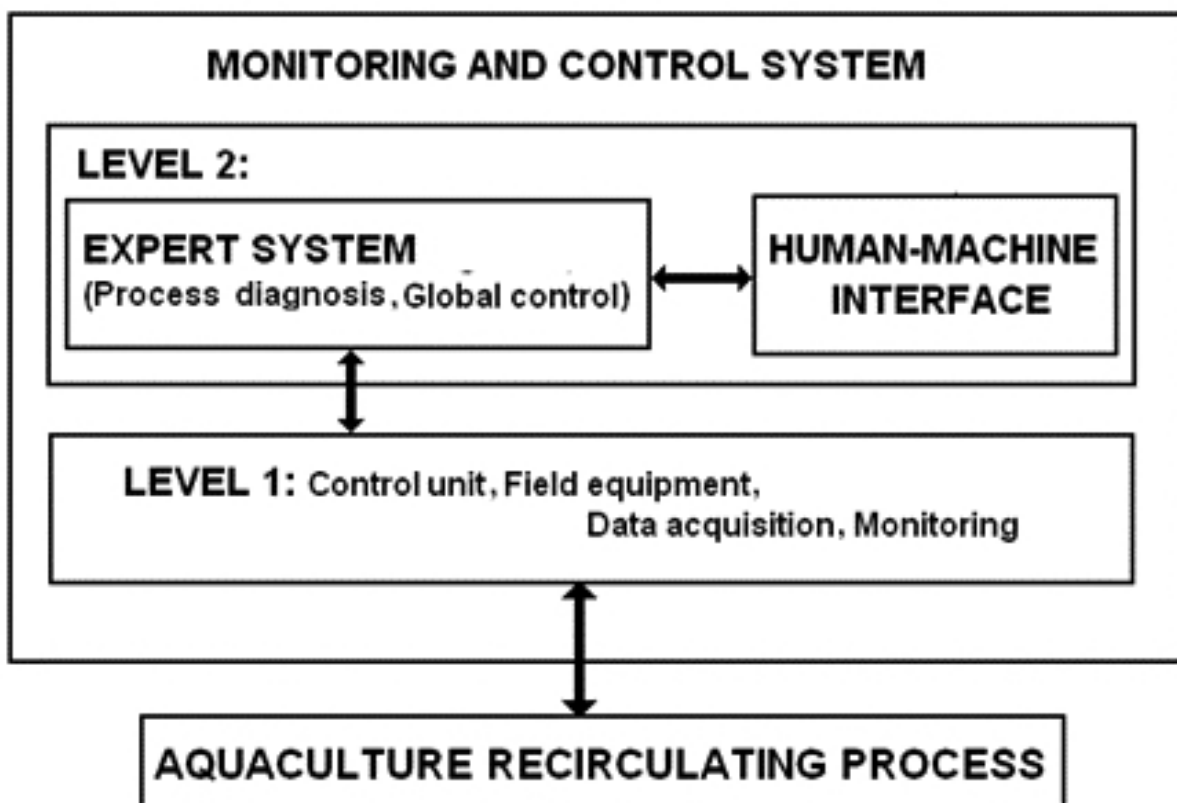

Figure 2. Monitoring and control system of recirculating aquaculture system.

Figure 3 shows the recirculating aquaculture process and the field equipment [4]. Two main circuits can be observed: a water circuit (blue) and an air circuit (red). The following field equipment can be noticed:

- Transducers: temperature (T1, T4, T7, T10 and T17); dissolved oxygen concentration (T2, T5, T8 and T11); water level in aquaculture tanks (T3, T6, T9 and T12); water level in the collecting tank located under the biofilter (T18); water flow (T13, T23–T26); pH (T15 and T20); ammonia concentration (T14 and T19); nitrate concentration (T21); nitrite concentration (T22).
- Actuators: electro-valves for air supplying control of the four aquaculture tanks (R1–R4); electro-valve for air supplying control of the trickling biofilter (R5); electro-valves for water supplying control of the four aquaculture tanks (R6–R9); pumps used for the pH control in the first collecting tank placed after the drum filter (one is for acid supply and the second is for base supply).

Another two pumps provide the necessary flow of the recirculated water within the intensive aquaculture plant. The first pump transfers the water from the drum filter to the sand and activated carbon filters and the second supplies the four aquaculture tanks with clean water taken from the biological filter.

The signal acquisition and the basic control loops are performed by a programmable logic controller (PLC), which is configured in accordance with the monitoring and control application of RAS. It communicates wireless with a computer in which the two software components, HMI and the expert system for process diagnose and global control of RAS, are implemented.

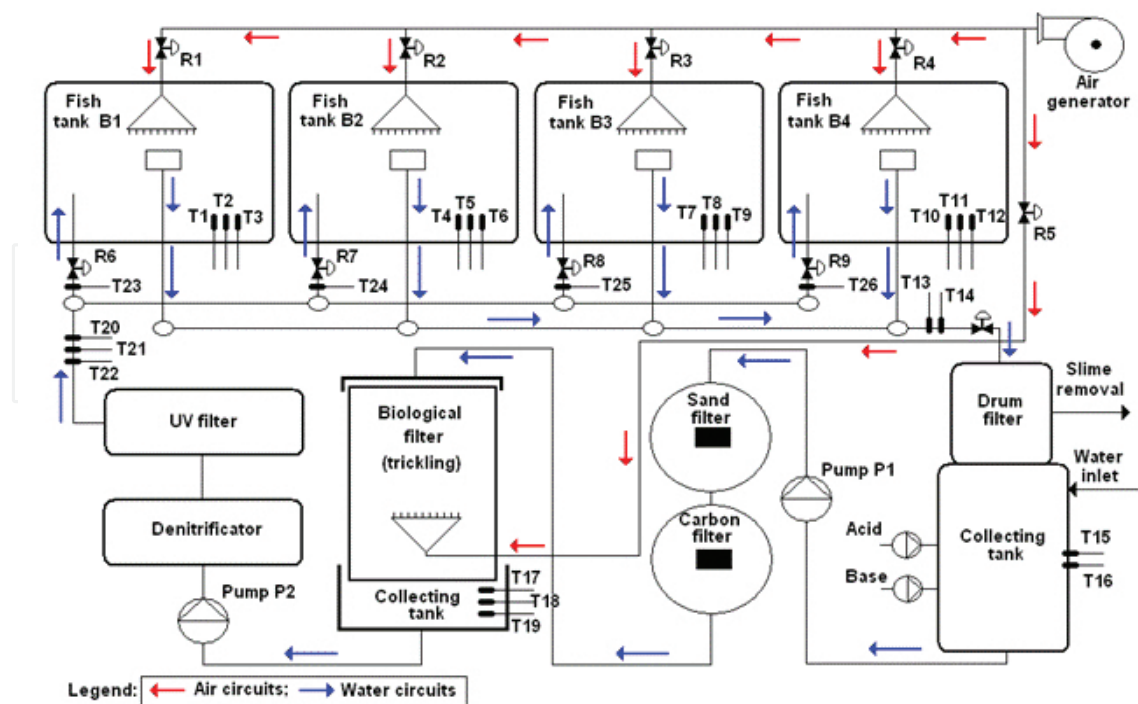

Figure 3. Experimental plant of the recirculating aquaculture system [4].

3. Mathematical modeling of intensive recirculating aquaculture systems

RAS contains three subsystems, which must be modeled: the biological system that means of culture biomass developing, the microbiological system that means of water quality and the recirculating hydraulic system that means the physical plant for water recirculating. The three subsystems have different time constants from a few minutes in the case of hydraulic system to several weeks in the case of biological system. The processes of interest, which will be approached further, are the biological process and, especially, the microbiological one. This is because the two subsystems mentioned above strongly influence the water quality, which is an essential factor for urban agriculture.

3.1. Mathematical modeling of the tanks for the growth of the fish biomass

Mathematical modeling of the tanks for the fish biomass growth involves two essential aspects:

- the model should provide information concerning the fish biomass which is in the aquaculture tanks at a given moment and the growth rate of the fish biomass. This is important to allow the calculus of the daily food ratio necessary for the proper development of the fish biomass and the estimation of the food percent assimilated by the fish biomass;
- the model should also provide information about the manner of residuals producing in aquaculture tanks. Thus, the production and consumption processes of the biochemical components of food (proteins, fat, carbohydrates, ash and water) should be considered among the types of processes occurring in the fish material: feeding, food digestion, mass growth and maintenance.

In order to estimate the fish biomass, the literature recommends two main models: using specific growth rate (SGR) or thermal growth coefficient (TGC). The second model is more advantageous compared with the use of SGR, because a very important factor of the fish biomass growth is taken into consideration: the temperature. In these conditions, the model which uses TGC will be considered for the fish biomass growth. At the same time, the model of the fish biomass growth should offer an estimation of the fish number in aquaculture tanks. These models are available between two weighing, therefore for a period of about 30 days. Based on the information about the growth rate of individual mass and the number of individuals from aquaculture tanks, the necessary daily food is determined through the feed conversion ratio (FCR).

In the modeling of the residual producing processes in aquaculture tanks, the purpose for which it is desired to build the model should be considered: achieving a global model of aquaculture plant. Thus, the model should be compatible from the state variables point of view with the model of the trickling biofilter. Therefore, it is necessary to determine a model having the following state variables: ammonia, inert components and dissolved oxygen. It starts from food decomposition in the main components: nitrogen, carbon and phosphorus. The food is introduced into aquaculture tanks in batch mode (1–2 times/day) or continuously. In the present study, taking into account that most of the plants are provided with discontinuous feeding, including the pilot plant from “Dunarea de Jos” University of Galati, it used the

assumption that the food is given in batch mode. The second step is to describe how these components are affected in the main processes that are related to the food of fish biomass: feeding, digesting food, mass growth and maintenance.

The two levels of the model interact as follows: information about the growth of the fish biomass determines the food amount introduced into aquaculture tanks. This is the input information of the residual producing.

The model TGC takes also into consideration the water temperature in the body mass growth of fish biomass [5]:

$$TGC = \left[(MI_f^{1/3} - MI_0^{1/3}) / (T \times t) \right] \times 1000 \quad (1)$$

where T is the water temperature ($^{\circ}\text{C}$), and t is the evolution time (days).

Mass changing during a period of the temperature evolution on days ($T \times t$) is given by the following equation:

$$MI(t) = \left[MI_0^{1/3} + TGC \times (T \times t) / 1000 \right]^3 \quad (2)$$

The derivative of Equation (2) leads to obtaining the individual body mass of the fish material:

$$CMI(t) = 3 \times TGC \times T \cdot \left[MI_0^{1/3} + TGC \times (T \times t) / 1000 \right]^2 / 1000 \quad (3)$$

To determine the mass of the fish material from aquaculture tanks, it is also necessary to model the evolution of the fish number during a production cycle. Thus, it is considered that number of individuals decreases with the age increase, the decrease being modeled through the decay coefficient [5]:

$$k = -1 / t_{CP} \cdot \ln(1 - p_M / 100) \quad (4)$$

where k is the decay coefficient, t_{CP} is the duration of the production cycle expressed in days, and p_M is the decay percent considered for the respective production cycle.

The number of individuals evolves along a production cycle accordingly to the equation:

$$n(t) = n(0)e^{-k \cdot t} \quad (5)$$

where $n(0)$ is the initial number of fishes.

In these conditions, the total fish mass can be estimated at each moment of time. The mass growth of the fish material can be determined through the derivative of the equation of total fish mass, resulting [5]:

$$CM(t) = n(t)(CMI(t) - k \times MI(t)) \quad (6)$$

Figure 4 shows the evolutions of individual body mass (a) and the number of individuals (b) when a 140-day production cycle is considered, compared with the experimental data collected from RAS.

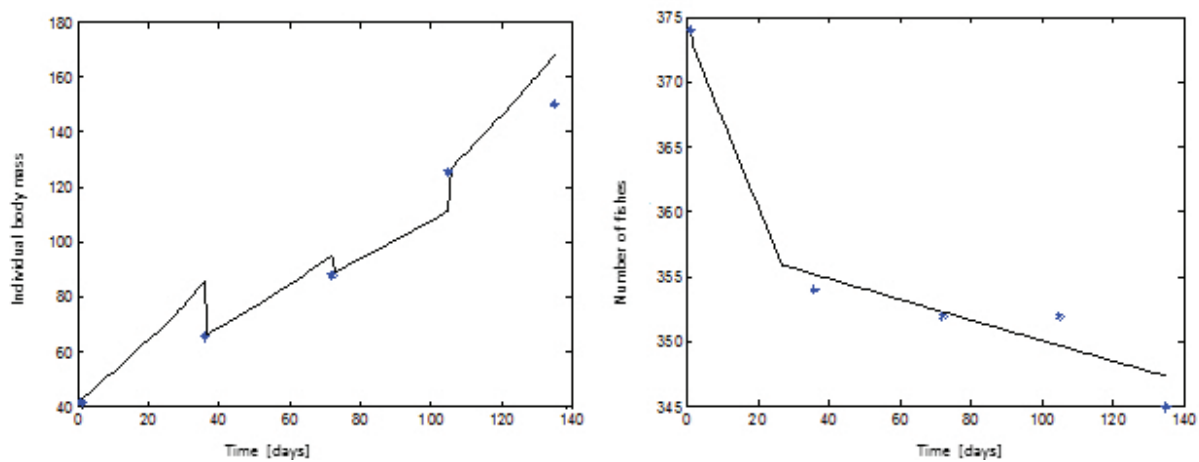

Figure 4. (a) Evolution of the individual body mass and (b) evolution of the number of individuals. Note: * = experimental data; solid line = model results.

For modeling the process of residuals producing by the fish biomass, the following four processes should be considered:

- feeding process: the food is introduced into aquaculture tanks in batch or continuous mode. The most part of food is consumed by fish, while a small fraction is lost in water;
- food digestion: after fish feeding, the amount of residuals from water increases reaching a maximum and then decreases monotonically. This process can be modeled as two first-order systems with delay, connected in series. Practically, it shows how the food is digested by the fish biomass and transformed into residuals;
- growth: this process assumes the existence of a consumption of the main elements introduced by food. The consumption is calculated in relation with the mass growth of the fish material;
- maintenance: the process determines a consumption of some elements, proportional to the total mass of fish.

The modeling of the residual producing process by the fish biomass starts from the biochemical composition of food. A typical composition of food is given in **Table 1**. Thus, for the calculus of nitrogen amount introduced through the food, it results: $N_{\text{food}} = 0.44 \times 0.16 = 0.064$ kg N/kg of food. It is considered that the food is given 2 times/day (at 6 AM and 6 PM) and the food introduced into aquaculture tanks is expressed by a function $f(t)$.

Element	Food (%)	COD (kg COD)	N (kg N)	P (kg P)
Protein	44	1.45	0.16	–
Carbohydrates	14	1.10	–	–
Fat	24	2.14	–	–
Ash	8	–	–	0.2
Water	10	–	–	–

Table 1. Biochemical composition of the food.

The food digested by the fish biomass is calculated as follows: $\tilde{f}(t) = L^{-1}\{G(s)\} \times f(t)$, where $L^{-1}\{\cdot\}$ is the inverse Laplace transformation, and $G(s)$ is the transfer function of the model of the food digestion [5]. This function will be used to determine the component of the unconsumed food lost in water $f(t) \cdot \varepsilon_p$ and the rate of residual discharge after digestion $\tilde{f}(t) \cdot (1 - \varepsilon_p)$, where ε_p is the ratio of the unconsumed food. In order to determine the consumption of the main elements introduced through the food for the mass growth of the fish, the signal $\delta_T(t)$ is considered (see Figure 5a). It means the graph of the modified feeding flow to obtain a function whose area in 1 day is equal to 1. Based on the signal $\delta_T(t)$ and the digestion model, the rate of discharge corresponding to the signal $\delta_T(t)$ is obtained: $s_F(t) = L^{-1}\{G(s)\} \times \delta_T(t)$. It is plotted in Figure 5b.

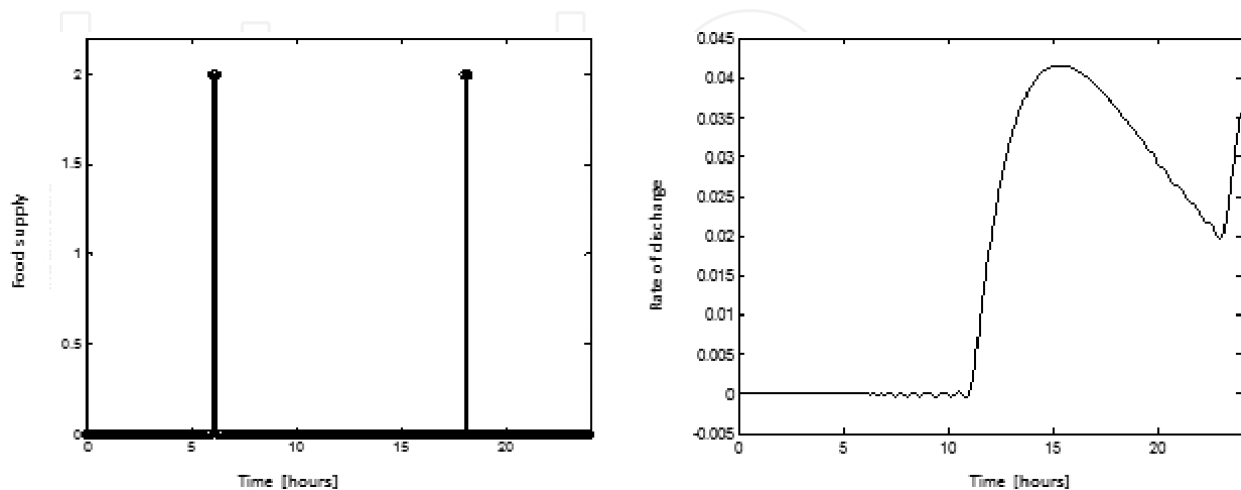

Figure 5. (a) Food supply of aquaculture tanks and (b) the evolution of the rate of discharge after digestion for 1 day.

Table 2 presents the matrix of residual producing, where the nitrogen (N) and inert substrate/biomass components (I) are highlighted. The maintenance process was not presented in Table 2 because it contributes only to the dissolved oxygen consumption without to affect other components considered in the model. The residuals production from aquaculture tanks is based on the **Table 2** and is given for each component by the sum of the following products: + Column 1 $\times f(t) \cdot \varepsilon_p$ + Column 2 $\times \tilde{f}(t) \cdot (1 - \varepsilon_p)$ - Column 3 $\times s_F(t) \times CM(t)$ - Column 4 $\times s_F(t) \cdot M(t)$ [5].

Residuals producing Variable	Feeding (kg of res./kg of food)	Digested food (kg of res./kg of food)	Mass growth (kg res./kg of fish/day)
S_{ND} – biodegradable soluble organic nitrogen	$0.5N_{hrana}$	$0.15N_{hrana}$	$-0.15N_{peste}$
X_{ND} – particles of biodegradable organic nitrogen	$0.5N_{hrana}$	$0.15N_{hrana}$	$-0.15N_{peste}$
S_{NH4} – ammonia	0	$0.7N_{hrana}$	$-0.7N_{peste}$
X_I – inert biomass	$0.5I_{hrana}$	$0.5I_{hrana}$	$-0.5I_{peste}$
S_I – inert substrate	$0.5I_{hrana}$	$0.5I_{hrana}$	$-0.5I_{peste}$

Table 2. Matrix of residuals producing.

3.2. Mathematical modeling and analysis of trickling biofilter

A biofilter of trickling type is composed by numerous vertical distributed solids which offer a large contact surface with the water that should be treated through the nitrification process. The biofilms are formed on each element of the filter, at a microscopic scale, carrying out the nitrification process. Two spatial coordinates intervene in the biofilter model: a spatial coordinate related to the biofilter height, z , corresponding to the processed water path, and a second spatial coordinate related to the biofilter thickness, ζ , corresponding to the processes from the biofilm. Taking into account the fact that the inert medium whereon the microorganisms are fixed, forming the biofilm, is not flooded, but it has wet surface and is aerated, it results that three zones which need to be modeled can be considered: the biofilm zone, the liquid zone (wastewater pellicle) and the gaseous zone. Furthermore, the flow of substance from gas to biofilm is considered null and only the biofilm and liquid zones will be modeled from the transfer of the components contained in the wastewater point of view. The gaseous zone will contribute only to the aerating process of the biofilm.

In what follows, the fundamental equations of the concentration of one component (ammonia, nitrate etc.) are considered in the biofilm and the liquid volume.

The model of concentration in the biofilm is [6]:

$$\frac{\partial c}{\partial \tilde{t}} = \frac{\partial^2 c}{\partial \xi^2} - r(c) \quad (7)$$

where c is the concentration of the component considered, ξ is the spatial coordinate related to the biofilter thickness, and $r(c)$ is the consumption rate of the component c . The spatial coordinate ξ is scaled: $\xi = \zeta/L$, where L is the biofilter thickness and $0 < \xi < 1$. The time is also scaled, $\tilde{t} = \lambda t$, $\lambda = D/(L^2 \varepsilon)$, where D is the diffusion coefficient, and ε is the biofilm porosity (m^3/m^3).

The boundary conditions of Equation (7) are:

$$\left(\frac{\partial c}{\partial \xi} \right)_{\xi=0} = 0 ; \quad (c)_{\xi=1} = c^b \quad (8)$$

where c^b is the concentration in the liquid volume.

The model of the concentration in the liquid volume is [6]:

$$v \frac{\partial c_i^b}{\partial t} = q \frac{\partial c_i^b}{\partial z} + a J_{f,i} + a_g J_{g,i}, \quad i = 1, 2, \dots, n \quad (9)$$

in which

$$v = V / (A_r h); \quad q = Q / A_r; \quad a = A / (A_r h); \quad a_g = A_g / (a_r h) \quad (10)$$

where c_i^b is the concentration of component i in liquid, $J_{f,i}$ is the flow of substance from the gas to biofilm, z is the spatial coordinate along the length of biofilter, A is the total area of biofilter, V is the total volume of liquid, A_g is the total area of the gas-liquid interface, A_r is the section area of the biofilter, h is the biofilter height, Q is the liquid flow which crosses the biofilter.

The flow from the biofilm to liquid, $J_{f,i}$ is expressed through the equation [6]:

$$J_{f,i} = -D_i \left[\frac{\partial c_i}{\partial \xi} \right]_{\xi=1} \quad (11)$$

where D_i is the diffusion coefficient for the component i .

In Equation (10), the spatial coordinate z is discretized in N finite zones which corresponds to the approximation of the distributed system model with respect to z by N concentrated parameter subsystems, connected in series, as shown in **Figure 6** (gaseous zone is consid-

ered to be common) [7]. At the level of each concentrated subsystem from **Figure 6**, the mass balance equation of the component considered has the following general form [6]:

$$V \frac{dc^b}{dt} = Q(c_{in}^b - c^b) + AJ_f + A_g J_g \tag{12}$$

where V is the liquid volume in the finite element of the subsystem, c^b is the component concentration in this finite element and c_{in}^b is the component concentration at the input of the finite element.

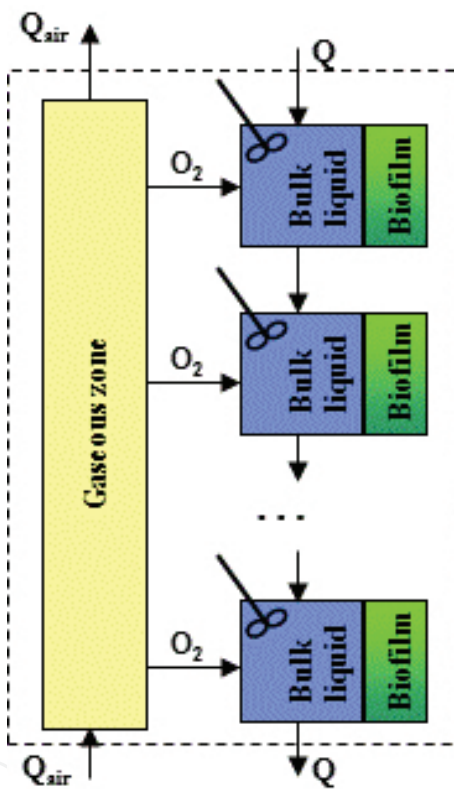

Figure 6. Structure of trickling biofilter [7].

Considering that the material flow from gas to biofilm is null and taking into account (11), Equation (12) can be written in the non-dimensional form [6]:

$$\tau \frac{dc^b}{dt} = c_{in}^b - c^b - \gamma \left[\frac{\partial c}{\partial \xi} \right]_{\xi=1}, \text{ with } \tau = \frac{V}{Q} \lambda, \quad \gamma = \frac{AD}{QL} \tag{13}$$

It is considered that the general model of biofilter is given by N equations of (13) form, for which every finite element resulted from the discretization of spatial coordinate, z , and N

equations of (7) form, these must offer the factor $\left[\frac{\partial c}{\partial \xi}\right]_{\xi=1}$ that intervenes in Equation (13) of each zone defined along the biofilter height.

Furthermore, the biofilter simulation through the model discretization was carried out, first of all considering the linear model of the concentration in biofilm.

If the substrate concentration is low, Equation (7) can be approximated by the following equation:

$$\frac{\partial c}{\partial t} = \frac{\partial^2 c}{\partial \xi^2} - kc \quad (14)$$

where k is obtained through the linearization of the equation of the substrate consumption rate (e.g. starting from the Monod law). Discretizing the spatial coordinate ξ in m finite zones, Equation (14) is transformed in the following system of differential equations:

$$\frac{dc_j}{dt} = m^2(c_{j-1} - 2c_j + c_{j+1}) - kc_j, \quad j = 1, 2, \dots, m \quad (15)$$

Considering the limit conditions (8), it results:

$$c_1 = c_0 = 0, \quad c_{m+1} = c^b \quad (16)$$

and the model of the concentration in biofilm becomes:

$$\begin{aligned} \frac{dc_1}{dt} &= -(m^2 + k)c_1 + m^2c_2 \\ \frac{dc_2}{dt} &= -(2m^2 + k)c_1 + m^2c_2 + m^2c_3 \\ &\dots\dots\dots \\ \frac{dc_m}{dt} &= -(2m^2 + k)c_{m-1} + m^2c_m + m^2c^b \end{aligned} \quad (17)$$

In what follows, it was adopted $m = 12$. For the discretization of spatial coordinate z , three finite elements ($N = 3$) were considered. Equation (13) can be written for each finite elements, in which the liquid concentrations are c_1^b, c_2^b, c_3^b . The terms $\left[\frac{\partial c}{\partial \xi}\right]_{\xi=1}$ come from the distinct discretized models of the biofilm, corresponding to the three finite elements. Denoting with k the current finite element ($k = 1, 2, 3$), the factor concerned may be written as follows:

$$\left[\frac{\partial c}{\partial \xi} \right]_{\xi=1} \cong \frac{c_m^{(k)} - c_{m-1}^{(k)}}{(1/m)} \tag{18}$$

A pulse was applied to the input of the simulated biofilter and the response obtained is shown in **Figure 7**. In this figure, the curves plotted for $k = 1$, $k = 2$ and $k = 3$ represent the responses obtained to the outputs of finite elements 1, 2 and 3, respectively ($k = 3$ corresponds to the biofilter output).

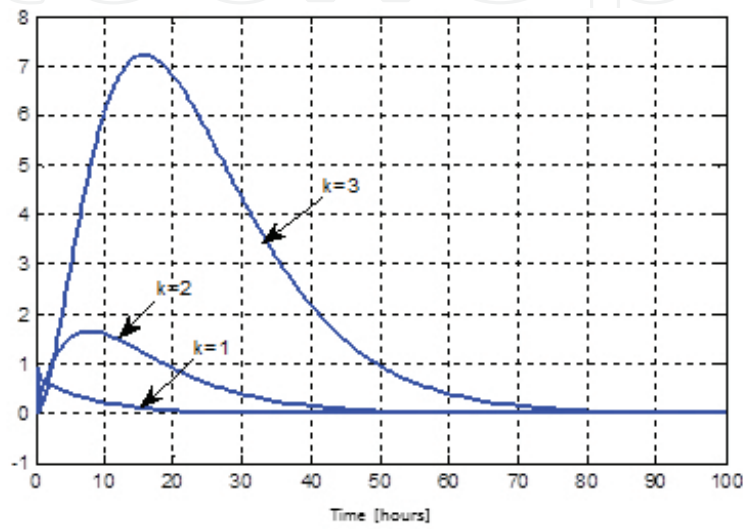

Figure 7. Pulse responses of the elements k from the biofilter structure (the case of linear model).

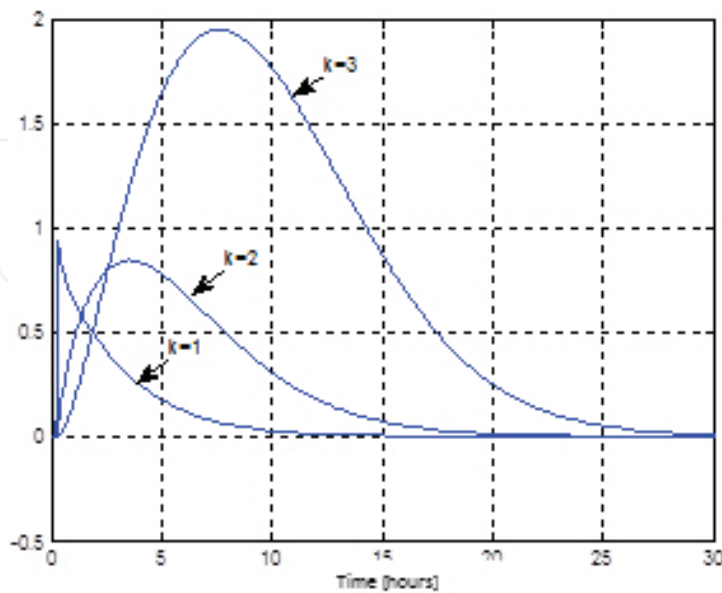

Figure 8. Pulse response of the elements k from the biofilter structure (the case of non-linear model).

It is now considered the non-linear case of the concentration model in biofilm in which, in Equation (7), the consumption rate of the component c , $r(c)$, has a given parameterization of the Monod type, such that the concentration model in biofilm becomes non-linear. **Figure 8** shows the pulse responses obtained to the outputs of the finite elements 1, 2 and 3, respectively.

Remark: The numerical methods used before transform partial differential equations in ordinary differential equations. The main advantage of these methods is that they can also be used in the case of non-linear systems, allowing the use of any type of analytical expression for the substrate consumption rate. The drawback of numerical methods is that they do not allow the obtaining of traditional models of transfer function type, Bode characteristics etc., used in usual control structures. Instead, by their means, internal model-based control (IMC) structures can be implemented.

In the software packages for modeling and numerical simulation of the biofilters, such as AQUASIM [8], the network method is used. It involves the simultaneous discretization of temporal and spatial coordinates. The model of trickling biofilter was implemented and its parameters were identified using the existent functions in AQUASIM. For simulations, a structure of trickling biofilter similar to the one shown in **Figure 6**, with $N = 5$ zones, was considered. The model implementation started from the fact that in the case of RAS, the main component of the wastewater reaching the trickling biofilter is ammonia, the organic substrate being negligible. Four processes that occur in the nitrifying biofilter of trickling type were considered. **Table 3** presents the reaction kinetics and stoichiometric coefficients of these processes, they being in accordance with the activated sludge model (ASM) [9].

Variable Process	Dissolved oxygen, S_{O_2}	Ammonia S_{NH_4}	Autotrophic biomass, X_A	Inert biomass X_I	Reaction kinetics
Autotrophic growth	$1 - \frac{4.75}{Y_A}$	$\frac{1}{Y_A}$	1	0	$\mu_A \frac{S_{O_2}}{K_{A,O_2} + S_{O_2}} \cdot \frac{S_{NH_4}}{K_{A,NH_4} + S_{NH_4}} X_A$
Autotrophic inactivation	0	0	-1	1	$k_A X_A$
Autotrophic maintenance	-1	0	-1	0	$b_A \frac{S_{O_2}}{K_{A,O_2} + S_{O_2}} X_A$
Aeration	1	0	0	0	$K_L a (S_{O_{2,sat}} - S_{O_2})$

Table 3. Reaction kinetics and stoichiometric coefficients of the model implemented in AQUASIM.

The model of trickling biofilter was simulated considering the parameters in accordance with those of Activated Sludge Model No. 1 (ASM1). The obtained results are shown in **Figure 9** [10], where it can be noticed that the biofilter reaches the steady-state regime. This simulation was necessary because all data are supplied by aquaculture pilot plant when the trick-

ling biofilter operates in the steady-state regime. The simulation considered that the biofilter has an initial thickness of 1 micron, corresponding to the thickness of a particle. Practically, it presents the result of the biofilm formation, observing that the system goes into the steady-state regime after about 120 days. The evolution of the main components, ammonia and dissolved oxygen at the output of the three zones of the biofilter (Zones 1, 3 and 5) are shown in Figure 9a and 9b, respectively. Figure 9c shows the graphical representation of ammonia concentration with respect to the biofilter thickness at the end of the simulation time. It can be noticed that in the points of interaction with the liquid volume, the ammonia concentration in biofilm is equal to the one from the liquid volume, and it decreases toward the inside of the biofilm. Figure 9d shows the evolution of the biofilm thickness in the three zones mentioned before. It can be observed that the evolution of the biofilm thickness inside the biofilter is determined by the decrease of ammonia concentration from water along the height of the biofilter.

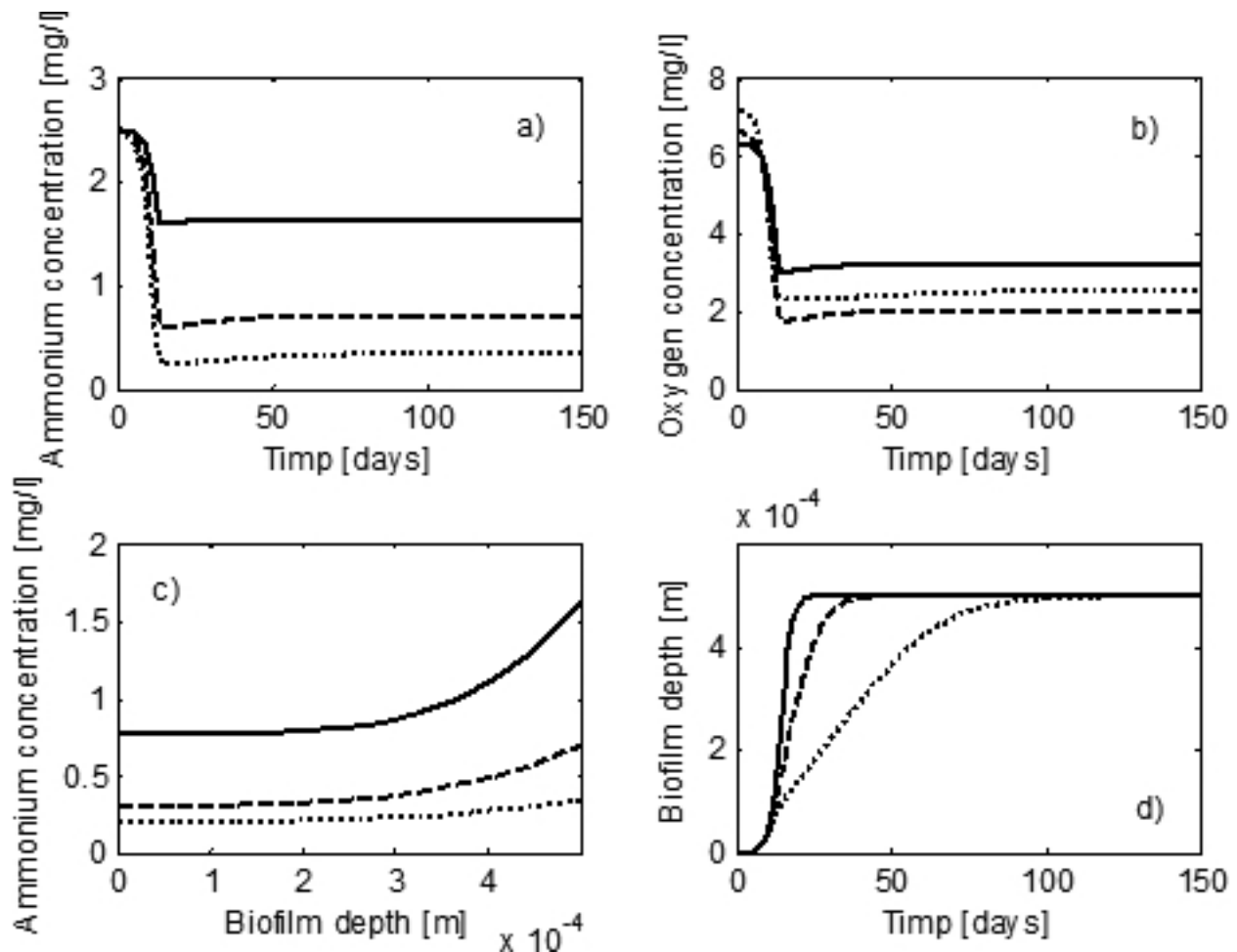

Figure 9. Simulation of the analytical model of trickling biofilter (Zone 1—solid line, Zone 3—dotted line and Zone 5—dashed line): (a) ammonia concentration in liquid volume; (b) dissolved oxygen concentration in liquid volume; (c) profile of ammonia concentration along the biofilm thickness; and (d) evolution of the biofilm thickness in trickling biofilter [10].

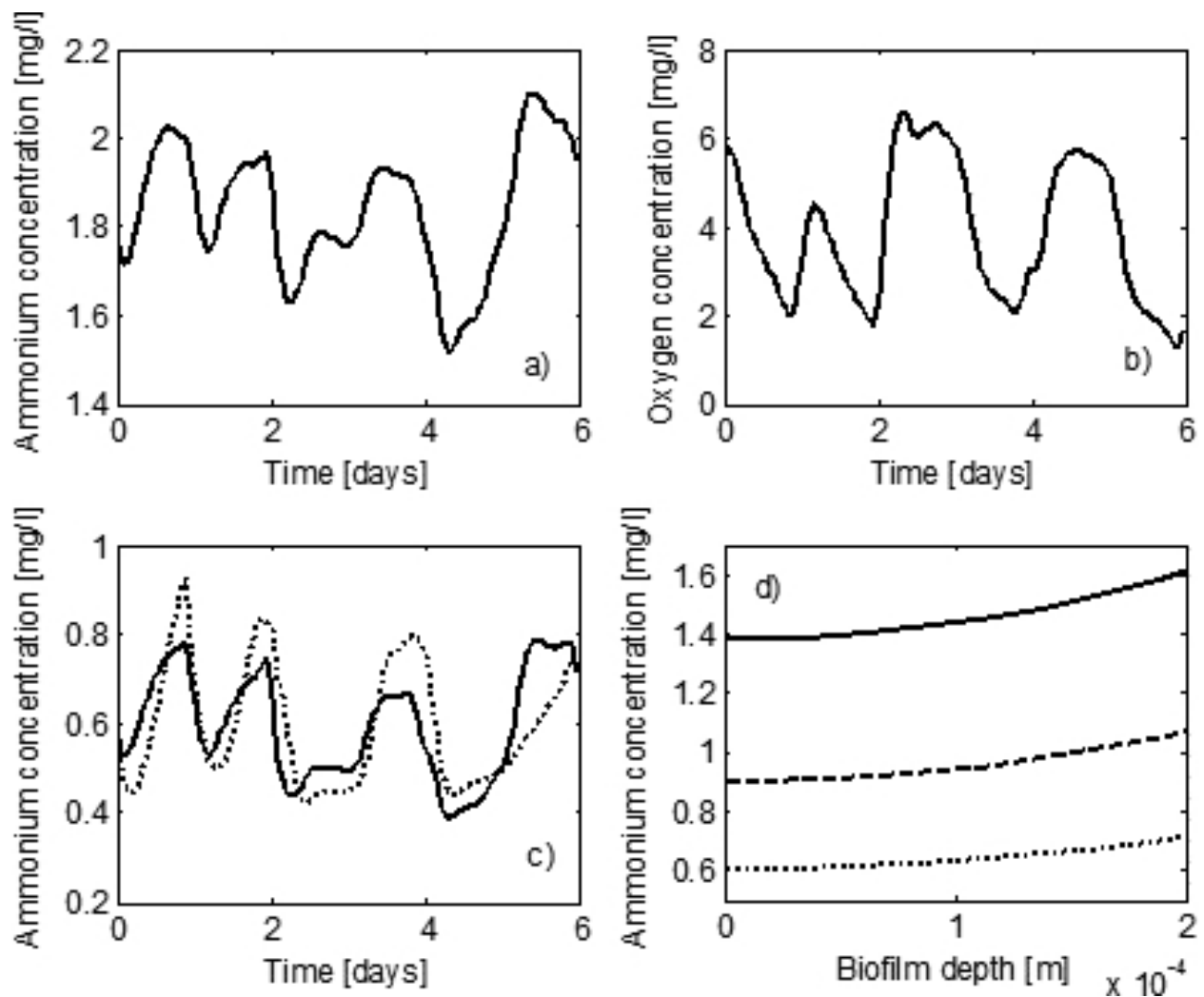

Figure 10. Simulation results of the identified model of trickling biofilter: (a) ammonia concentration in the influent; (b) dissolved oxygen concentration in the influent; (c) ammonia concentration in the effluent (experimental data—dashed line, evolution of the identified model—solid line); and (d) ammonia concentration along the biofilm thickness (Zone 1—solid line, Zone 3—dotted line and Zone 5—dashed line) [10].

The major advantage of this model implemented in AQUASIM is that it provides a detailed description of the phenomenology that takes place in the trickling biofilter. Thus, the model was also used as emulator to generate data from biofilter in other modeling studies.

A solution to obtain a simpler mathematical model is the modeling of trickling biofilter using an adaptive filter. Although the trickling biofilter is a non-linear system with distributed parameters, for control goals is sufficient to know its linearized mathematical model around the current operating point. Obviously, if the operating point of the biofilter changes, it is necessary to determine the updated linear model. In these conditions, the trickling biofilter can be treated as a variant dynamic system with distributed parameters [7]. A powerful tool to identify these systems is the adaptive filter.

Let us consider $h_a(t)$ and $h_o(t)$ the pulse responses of the biofilter on the channels $\text{NH}_{4,\text{in}}(t) \rightarrow \text{NH}_{4,\text{out}}(t)$ and $Q_{\text{in}}(t) \rightarrow \text{NH}_{4,\text{out}}(t)$, respectively. Based on the samples of the pulse responses $h_a[k]$ and $h_o[k]$, where k is the discrete time, the vectors of pulse responses $h_a[k]$ and $h_o[k]$ are formed. By noting $\mathbf{h}[k] = [\mathbf{h}_a^T[k] \quad \mathbf{h}_o^T[k]]^T$ and the samples of ammonia concentration and the inflow with $\mathbf{x}[k] = [\mathbf{x}_{\text{NH}_{4,\text{in}}}^T[k] \quad \mathbf{x}_{Q_{\text{in}}}^T[k]]^T$, the process model can be written as follows:

$$y[k] = \mathbf{h}^T[k] \mathbf{x}[k] \quad (19)$$

where $y[k] = \text{NH}_{4,\text{out}}[k]$.

The adjustment of the parameter vector, $\mathbf{h}[k]$, is done with the well-known recursive least square (RLS) algorithm [11]. On the basis of pulse responses $h_a[k]$ and $h_o[k]$, determined with RLS algorithm, the frequency characteristics of the process can be obtained. They represent the starting point of the methodologies of interactive frequency design of the control algorithms of trickling biofilter.

In the case of trickling biofilter, there are three variables that can modify the operating point: the feed flow rate of trickling biofilter (which actually is the recirculating flow), Q_{in} ; ammonia concentration from the influent of trickling biofilter (which actually is the ammonia concentration in aquaculture tanks), $\text{NH}_{4,\text{in}}$; and dissolved oxygen concentration in the water treated in trickling biofilter (determined by the dissolved oxygen concentration in aquaculture tanks and the aerating processes from trickling biofilter).

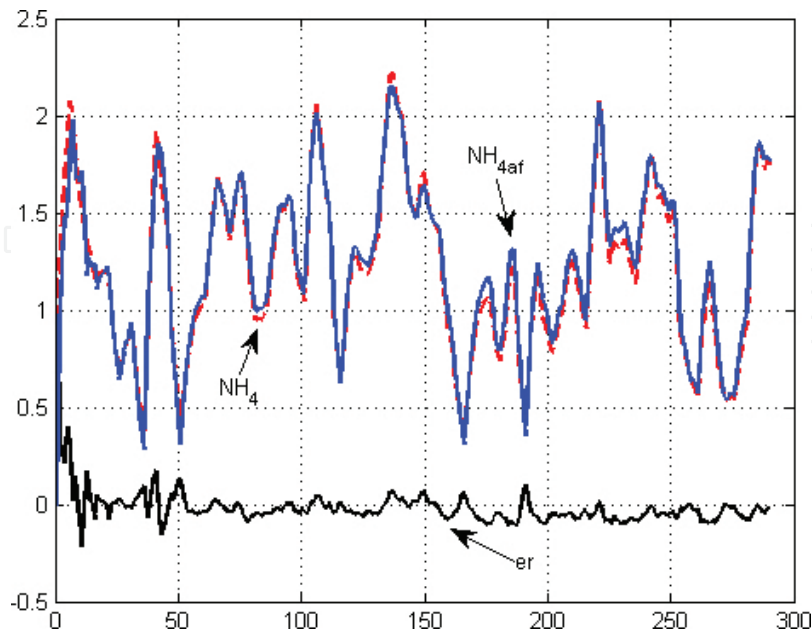

Figure 11. Validation of the identified model using adaptive filters (model output—blue line, output of the emulated process—red line and identification error—black line).

To highlight the modification of the properties of the adaptive dynamic model when the operating regime of biofilter changes, two extreme operating regimes were considered:

- High flow: $Q_{in} = 4 \text{ m}^3$ and $\text{NH}_{4,in} = 2 \text{ mg N/L}$;
- Low flow: $Q_{in} = 2 \text{ m}^3$ and $\text{NH}_{4,in} = 4 \text{ mg N/L}$.

It can be noticed that in aquaculture plant, in the two operating regimes, the same amount of nitrogen can be found: 8 g. It can be also noticed that in the mentioned situation, a constant value of dissolved oxygen concentration was considered: $\text{DO}_{in} = 4 \text{ mg O}_2/\text{l}$. The software implementation in AQUASIM of the analytical model determined by identification was used as process emulator, obtaining the process output in the three operating regimes. **Figure 11** shows an example of identification using adaptive filters. In **Figure 11**, a very good match can be noticed between the output of the identified model and the one of the emulated process.

Figure 12 shows the Nyquist frequency characteristics of the channel $Q_{in}(t) \rightarrow \text{NH}_{4,out}(t)$. Analyzing these characteristics, it can be seen that the water flow which supplies the trickling biofilter has a great influence on the process dynamics. The change of the flow leads to the change of the gain and time constants of the transfer function identified on this channel.

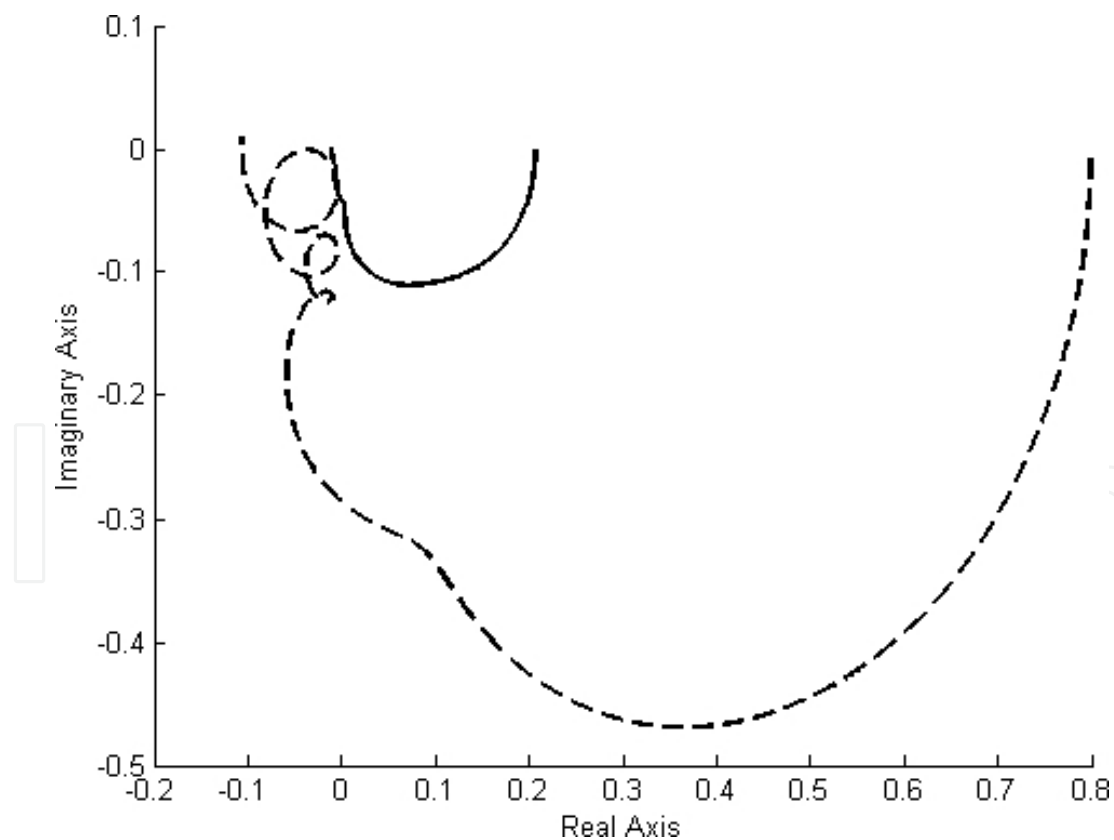

Figure 12. Nyquist frequency characteristic of the channel $Q_{in}(t) \rightarrow \text{NH}_{4,out}(t)$ (regime high flow—solid line and regime low flow—dashed line).

Figure 13 shows the Nyquist frequency characteristics of the channel $\text{NH}_{4,\text{in}}(t) \rightarrow \text{NH}_{4,\text{out}}(t)$. It is a disturbing channel, the ammonia concentration at the input of the trickling biofilter being determined by metabolic processes that take place in aquaculture tanks. From the analysis of the figures previously presented, it can be noticed that, despite a significant influence of this channel on the output in the two operating regimes, it has similar dynamic properties at low and medium frequencies.

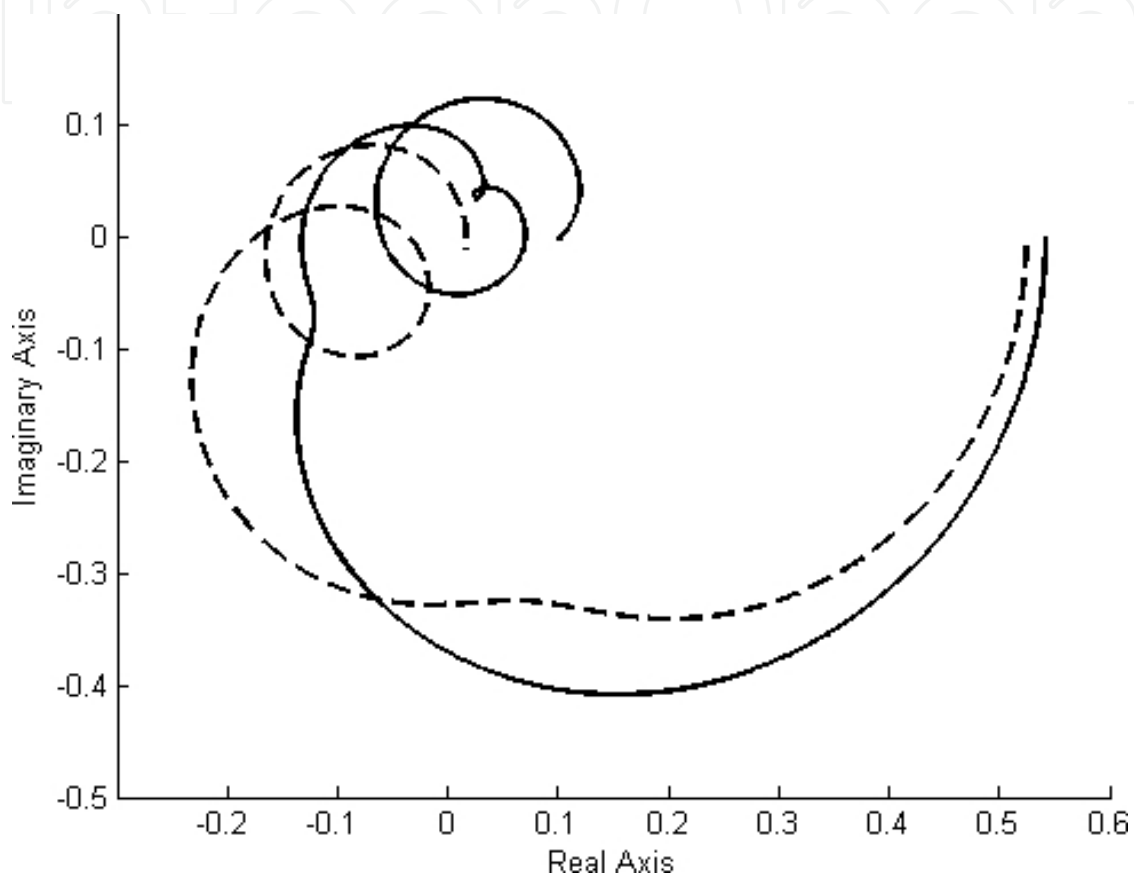

Figure 13. Nyquist frequency characteristic of the channel $\text{NH}_{4,\text{in}}(t) \rightarrow \text{NH}_{4,\text{out}}(t)$ (regime high flow—solid line and regime low flow—dashed line).

Finally, an analysis of the dynamic properties of the channel $\text{DO}_{\text{in}}(t) \rightarrow \text{NH}_{4,\text{out}}(t)$ was performed, and the obtained results showed that there is not a significant dynamics of this channel in the frequency domain of interest.

This analysis highlighted that the main control variable existent in the case of trickling biofilters is the recirculated flow. The analysis also showed that the dynamic properties of the control channel $Q_{\text{in}}(t) \rightarrow \text{NH}_{4,\text{out}}(t)$ vary greatly with respect to the operating point, from the two points of view: gain and time constants [7]. Thus, it results the necessity to use robust control techniques by the approximation of this channel with variable parameter linear models. The control of the recirculated flow can be performed directly if the aquaculture plant is equipped with variable flow recirculating pumps or indirectly through the control of the water level in aquaculture tanks.

In the case of the control channel $DO_{in}(t) \rightarrow NH_{4,out}(t)$, the lack of significant dynamics was highlighted. At the same time, in practical investigations on the pilot plant, it can be noticed that the use of the control to aerate the trickling biofilter does not lead to satisfactory results [7]. In these conditions, the indirect control of dissolved oxygen concentration in the water inside the trickling biofilter can be done through the direct control of dissolved oxygen concentration in the water from aquaculture tanks.

In order to design a control system of trickling biofilter must also take into account the disturbing channel $NH_{4,in}(t) \rightarrow NH_{4,out}(t)$. This channel is influenced by the food introduced into aquaculture plant and the metabolic processes of the fish population [7]. These processes represent the determining factors in establishing the operating mode of a recirculating aquaculture plant. Depending on ammonia concentration in aquaculture tanks, the recirculating flow within the plant is set. Thus, it seeks to establish inside the plant an ammonia concentration of the water of maximum 1 mg N/L. For the disturbing channel $NH_{4,in}(t) \rightarrow NH_{4,out}(t)$, techniques of feed-forward type or robust control can be used, if this disturbance is not measurable.

4. Experimental results regarding RAS dynamics and control

To emphasize the dynamic properties of RAS and the control solutions, an experiment in which a species having an intensive metabolism (*Cyprinus carpio*) was carried out. Thereby, a high ammonia concentration was obtained in this experiment. **Table 4** presents the biomass distribution in the tanks of RAS [12].

Tank number	Mass (kg)	Number of individuals	Average mass/individual (g)
1	$C_1 = 13,616$	665	20.47
2	$C_2 = 13,614$	557	24.44
3	$C_3 = 13,855$	614	22.61
4	$C_4 = 13,710$	591	23.19

Table 4. The populating mode of aquaculture tanks [12].

The fodder Optiline 1 P of 2 mm having 44% content of protein [13] was used for feeding the fish biomass.

The data were collected from the process during two experiments: the first experiment used a continuous distribution of the fodder, and the second a discontinuous one giving three ratios per day (at 9:30, 14:00 and 18:30). The first experiment was lengthy, and it used a sample period of 10 minute; the second was of shorter duration, with 1 minute sampling period.

The analysis of the process data in order to monitor RAS highlights that all physical variables are affected by an important high-frequency noise which imposes the use of an efficient

filtering system. In the developed monitoring system, the filtering subsystem is composed of two units in series: a non-linear filter for the removal of the important short-duration variations and a classic linear filter of second order for the ordinary high-frequency noise. Figure 14a shows the effect of the filtering system to the acquisition of a signal given by ammonia sensor from the biological filter.

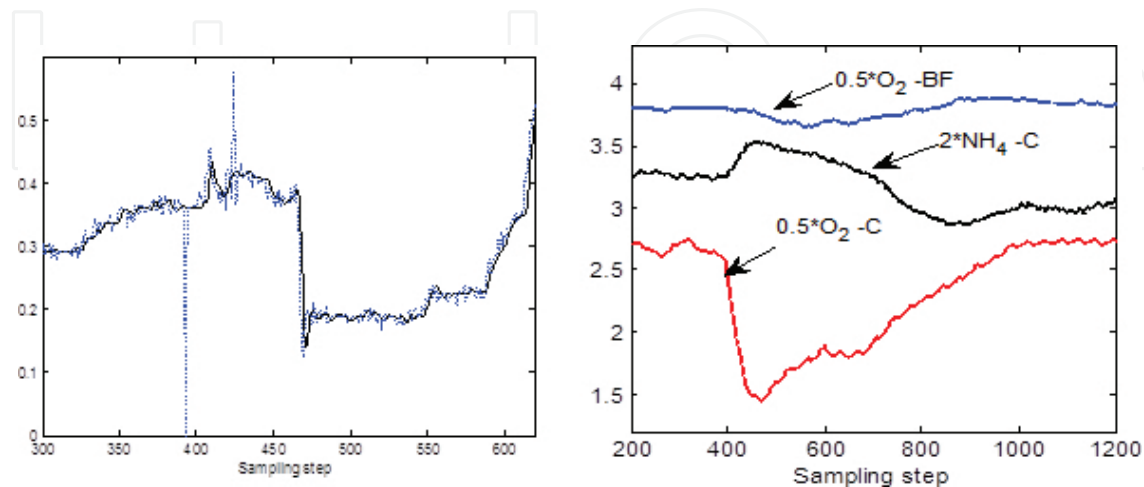

Figure 14. (a) Sample of ammonia concentration at the biological filter output, $\text{NH}_4\text{-BF}$ (mg/L): unfiltered (dot) and filtered signal (solid); (b) evolution of ammonia concentration at the biofilter input, $\text{NH}_4\text{-C}$ (mg/L) (red) and of oxygen concentrations at the biofilter input and output, respectively, O_2 and $\text{O}_2\text{-BF}$ (mg/L) (red and blue, respectively).

Together with high-frequency disturbances, the collected signals may be affected by a slow drift due to the deposition of biofilm on the sensitive surfaces of the sensor from the liquid medium. Therefore, it was necessary to apply a careful maintenance to reduce these errors.

The main disturbance that affects the acquired variables from RAS is the one resulted from the fish feeding. This has two components: the first composed of dejections and metabolism products, which constitute the main component, and the second – the organic substances resulted from the decomposition of the unconsumed fodder. Figure 14b shows the variations of the oxygen concentrations inside the aquaculture tanks (O_2), the biological filter ($\text{O}_2\text{-BF}$) and the ammonia concentration collected at the biofilter input ($\text{NH}_4\text{-C}$) considering a 1 minute sample period, when the fodder is given in batch mode. After about 3 hours from the feeding, the ammonia concentration increased fast, and then, after 10–11 hours, the concentration returned to the initial concentration, as a result of the action of the biological filter and denitrificator from the recirculated water circuit [12]. Figure 14b shows that, at the same time with the increase of ammonia concentration, a pronounced decrease of the oxygen concentration in the aquaculture tanks takes place. The effect on the oxygen concentration at the biofilter output is much lower.

The internal pseudo-periodical disturbances have an important weight in the RAS dynamics. They are generated by the washing processes of mechanical, sand and carbon filters [4, 12]. The wash of the mechanical filter is accompanied by a loss of water removed from the system together with the slime, which causes a sudden decrease of the water level in aquaculture tanks.

At the same time, the wash of sand and active carbon filters is achieved through their bypass. When the filters are recoupled in the circuit, a sudden decrease of the water level in aquaculture tanks occurs. In both cases, the systems that provide the imposed water level in the tanks perform the compensation of water losses through an intake from the water network. The internal disturbances produced by the cyclic operating of mechanical, sand and active carbon filters generate a complex dynamics of RAS when it operates in permanent regime. Analyzing this dynamic regime offers useful information for the system control. Thus, **Figure 15** shows the evolutions of ammonia and oxygen concentrations at the biofilter's input and output ($\text{NH}_4\text{-C}$ and $\text{NH}_4\text{-BF}$, O_2 , and $\text{O}_2\text{-BF}$, respectively). These variations show the biofilter efficiency through the significant difference between ammonia and oxygen concentrations at the biofilter's input and output. Obviously, the two types of physical variables have evolutions, mostly, in anti-phase.

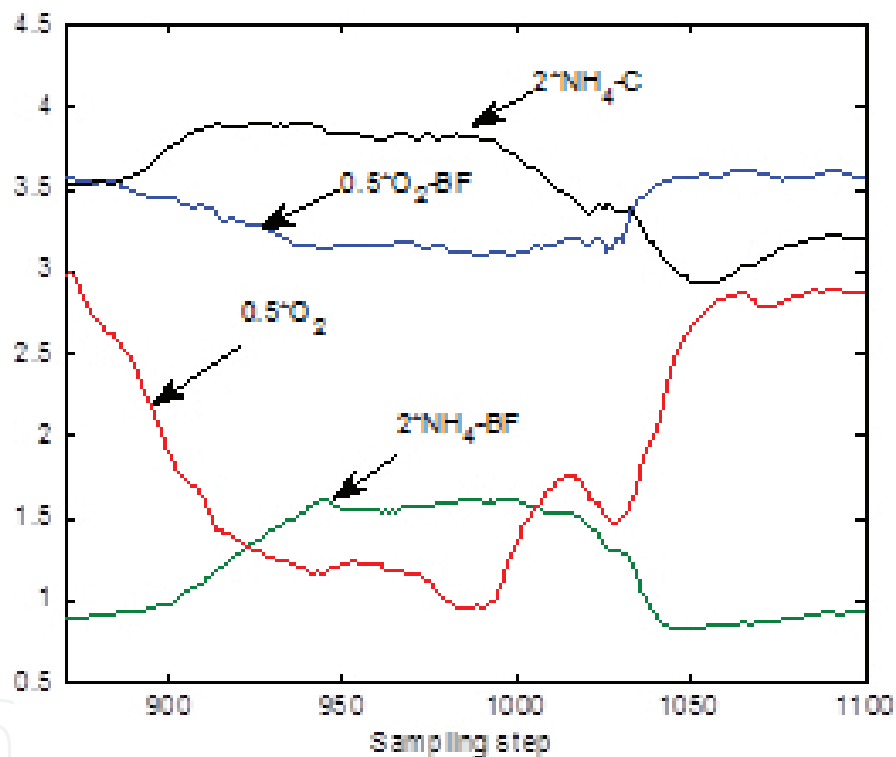

Figure 15. Evolutions of ammonia concentrations at biofilter input and output, $\text{NH}_4\text{-C}$ and $\text{NH}_4\text{-BF}$ (mg/L) (black and green, respectively) and of oxygen concentrations at biofilter input and output, O_2 and $\text{O}_2\text{-BF}$ (mg/L) (red and blue, respectively).

As shown in Section 2, the control of RAS is structured into two hierarchical levels. The first level performs data acquisition, their processing according to the necessities of monitoring and control functions (in this case, the operation of disturbance and high-frequency noise removal, which have an important weight, is essential), and the control loops. These loops are referring to the water level and oxygen concentration in aquaculture tanks and to pH control in the collecting tank located to the output of mechanical filter. **Figure 16** shows the response of pH control system when the operating regime switches acid/base.

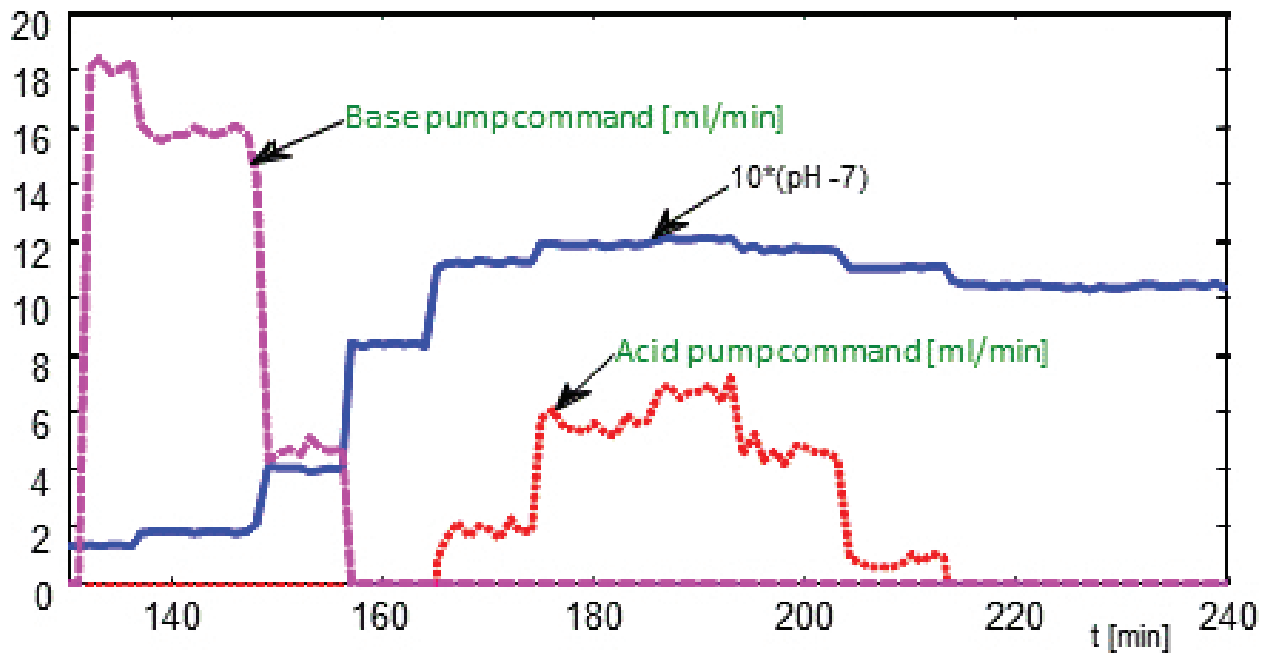

Figure 16. The response of pH control system.

For economic reasons, the water circulation in RAS is achieved by two pumps with constant flow. Both pumps are controlled in on–off regime by the controllers that provide a constant level in the two collecting tanks located after the mechanical filter and after trickling filter. This solution does not allow the direct control of the recirculated flow in the aquaculture system. The flow adjustment can be done through the average level imposed in the aquaculture tanks. Figure 17a shows the correlation between the evolution of the average level, L , and the total inflow in aquaculture tanks, IF_t . In this graph, the signal IF_t is obtained using a moving average filter, to whose input the sum of the inflows in the aquaculture tanks is applied. For RAS operating necessities, a nomogram determined experimentally from which the water level set point in aquaculture tanks is deduced, aiming to obtain a desired adjustment of the recirculated flow is used.

To control the nitrification process through the trickling filter, some solutions were investigated, the first being the use of the recirculating flow as control variable. Generally speaking, the increase of the recirculating flow leads to the decrease of ammonia concentration in the aquaculture tanks. However, the domain of the recirculating rate is limited both in terms of technologically and also due to the cost of the consumed electrical energy. The control of the nitrification process is practical compromised because of strong variations of the physical variables of the system that are produced by the washing processes of mechanical, sand and active carbon filters. Figure 17b shows a fragment from a record of the recirculating flow affected by two consecutive washes of a filter, together with the corresponding variation in ammonia concentration at trickling filter output. It is obvious that internal disturbances from RAS make it difficult to discern the effects of the control applied to the recirculating flow by the variations induced through these internal disturbances.

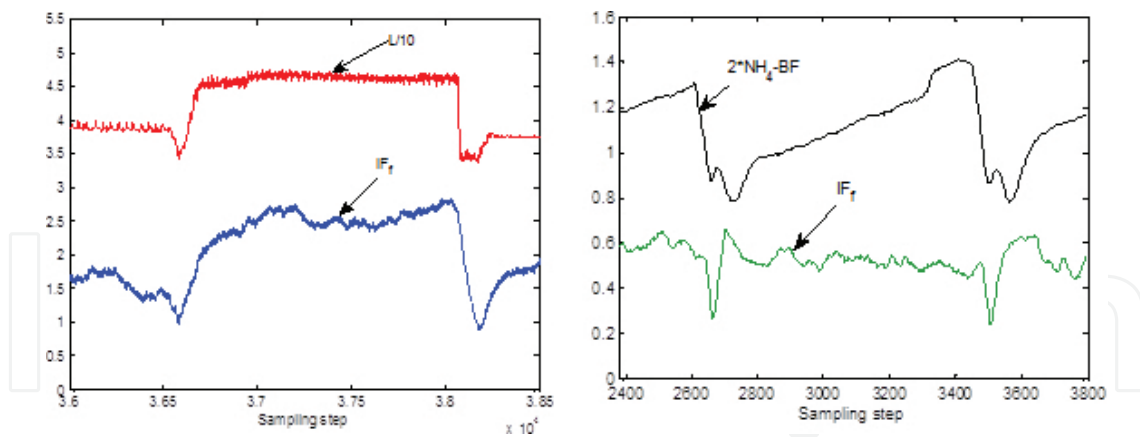

Figure 17. (a) Evolution of the level in the tank located after mechanical filter, L (cm), and of total inflow of the aquaculture tanks (filtered), IF_f (m³/h); (b) evolution of recirculating flow, IF_f (m³/h) affected by two consecutive washes of filters, together with the corresponding variation of ammonia concentration in biofilter $NH_4\text{-BF}$ (mg/L).

The opportunity to increase the biofilter efficiency was also analyzed by an aerating process in countercurrent to the flow of the processed water. It was found that the aerating control of the biofilter has practically a negligible effect so that such a solution is not appropriate. Because of spaces between balls inside the trickling biofilter, a sufficient natural aeration is produced, which excludes a supplementary aerating system [12]. An indirect control solution of the nitrification process is suggested by the connection between oxygen concentration in the aquaculture plant and ammonia concentration at the biofilter output, $NH_4\text{-BF}$ (**Figure 18**). If necessary, the reducing of ammonia concentration at the biofilter output can be performed by a control aiming to intensify the aeration of aquaculture tanks.

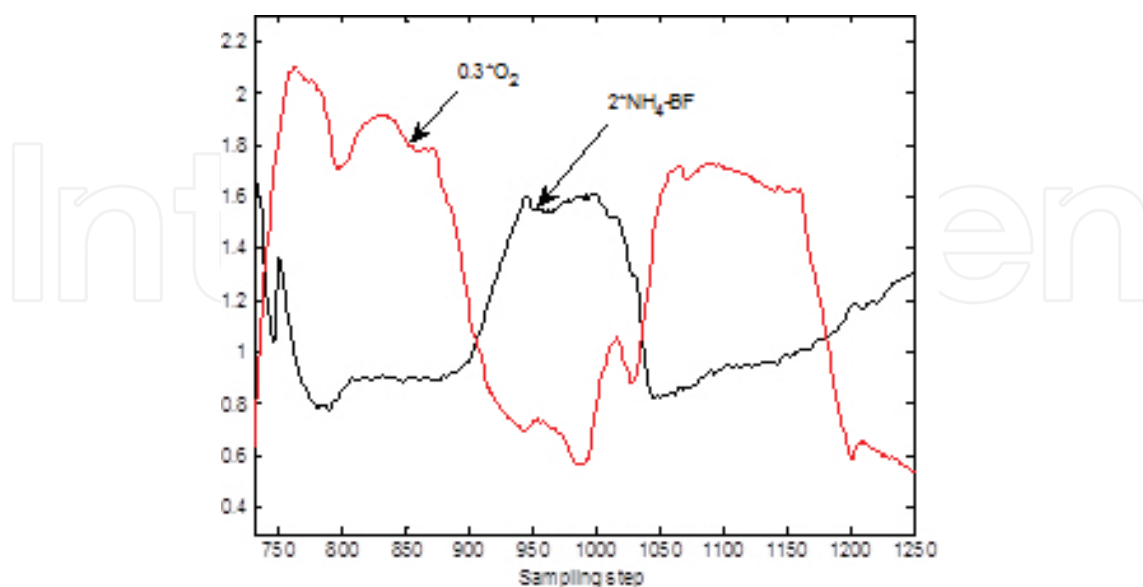

Figure 18. Evolution of ammonia concentration at biofilter output, $NH_4\text{-BF}$ (mg/L) (black) and of oxygen concentration in aquaculture tanks, O_2 (mg/L) (red).

As a conclusion, due to the fact that the trickling filter does not have proper means of control, the nitrification process can be controlled only through the recirculating flow or, if necessary, through aeration intensification of aquaculture tanks. The high level of system's disturbances, especially those produced by the operation of mechanical, sand and carbon filters, requires the use of the qualitative description of the essential variables of RAS, which is presented in this section, to create a rule-based system for RAS control.

5. Expert system for monitoring and control of the recirculating aquaculture process

For monitoring and overall control of the aquaculture recirculating process, an expert system that uses the human expertise in the aquaculture field has been implemented. It contains over 200 rules and performs the following functions: monitoring of data acquisition process, monitoring of control loops operation, monitoring the chemistry of the water recirculating system, the establishing of nutrition strategy, and monitoring of technological performance. The expert system relies on production rules and it consists of the following modules: the database, the base of facts, the knowledge base, the inference engine and the HMI.

The database can be viewed as an auxiliary memory that contains the following data:

- online measured data. These data are provided by the process sensors considering a sample period equal to 1 minute. The following measured variables can be mentioned: temperature current value, oxygen concentration current value, water level current value in the aquaculture tanks, ammonium concentration current value etc.
- data initialized by operator (the absolute minimum or maximum value of the oxygen concentration in the aquaculture tanks, the maximum admissible value of the ammonium concentration in the biological filter etc.)
- data provided by the operators or calculated during the process. The operator should introduce every 2 weeks the total number of individuals from the tank B_i , $i = 1, 4$, the weight of each individual etc. On this basis, the following variables are calculated: the total fish biomass at the current step, the SGR, the food conversion factor etc.

The base of facts: The facts are defined as simple sentences as follows: water temperature = 15°C, O_2 concentration in the tank $i = 3$, NH_4 concentration in the biological filter = 0.15 (mg/L), NO_3 concentration = 50 mg/L etc.

The knowledge base: It contains a production rules network of *IFpremiseTHENconclusion/Prio/Comment* type. The following sources have been used for the knowledge acquisition: interviewing the specialist, making experiments and literature. The premise may contain logical operators of AND, OR, NOT type. The conclusion may signal a certain state of the process and may suggest an appropriate action. Furthermore, some examples of rules are presented:

- Monitoring rules of data acquisition

IF $\{O2cM - O2cBi > 2\}$ **THEN** {The O_2 sensor from the tank i is faulty or the tank aeration is damaged}/**Prio N/Comment:** Check and eventually calibrate the sensor. The blower can be disconnected through thermal protection or the blower flow be insufficient,

where $O2cM$ is the maximum value of the oxygen concentration, $O2cBi$ is the current value of the oxygen concentration and **Prio N** is the normal priority.

IF $\{NH4cC - NH4mFB < 0.5\}$ **AND** $\{NH4cC - NH4mFB > 0\}$ **THEN** {Faulty evolution of the nitrification process}/**Prio H/Comment:** Check the biofilter operation (if the liquid flux is uniformly distributed on the biofilter section),

where $NH4cC$ is the current value of the ammonium concentration, $NH4mFB$ is the ammonium concentration measured in the last hour inside the biological filter and **Prio H** is the high priority.

- Monitoring rules of the chemistry of recirculating water system

IF $\{pHc \leq 6,5\}$ **THEN** {The pH is less than the admissible limit}/**Prio N/Comment:** Check if there is alkaline agent in the control loop **AND** increase the water recirculating flow **OR** increase the water refresh flow,

where pHc is the current value of pH.

- Rules for establishing the feeding strategy

IF $\{GMIi \in (10-50 \text{ g})\}$ **AND** $\{TcBi \in (18, 20^\circ\text{C})\}$ **THEN** {The food rate in the tank i is $(3\%/MCi)$ }/**Prio N/Comment:** Set the food rate for the fish of this age category,

where $GMIi$ is the average weight of the individual in the tank i , $TcBi$ is the current value of the temperature in the tank i and MCi is the body mass of an individual in the tank i .

- Monitoring rules of the technological performance

IF $\{GMIi \in (50-200 \text{ g})\}$ **AND** $\{SGR < 3\%\}$ **THEN** {The fish biomass in the tank i does not develop normally}/**Prio N/Comment:** Check the technological conditions **AND/OR** the food rate should be adapted,

where $GMIi$ is the average weight of the individual in the tank i , SGR is the specific growth rate, $SGR_k = 100 (\ln B_k - \ln B_{k-1})/t$, where t is the time between the last two weighing.

The inference engine: In the present control application, a forward-chaining strategy, specific to the expert systems based on production rules, was used. The reasoning is of deductive type, from the facts to the goal.

HMI: The process is operated by a friendly graphical interface that communicates with the expert system. The main screen of the interface (**Figure 19**) contains a synoptic scheme of the process where it can be seen the global state of the process [14]. HMI gives to the operator the possibility to visualize online the main variables of the process, to control the process in manual or automatic regime, to plot and to store the values of the process variables for later processing.

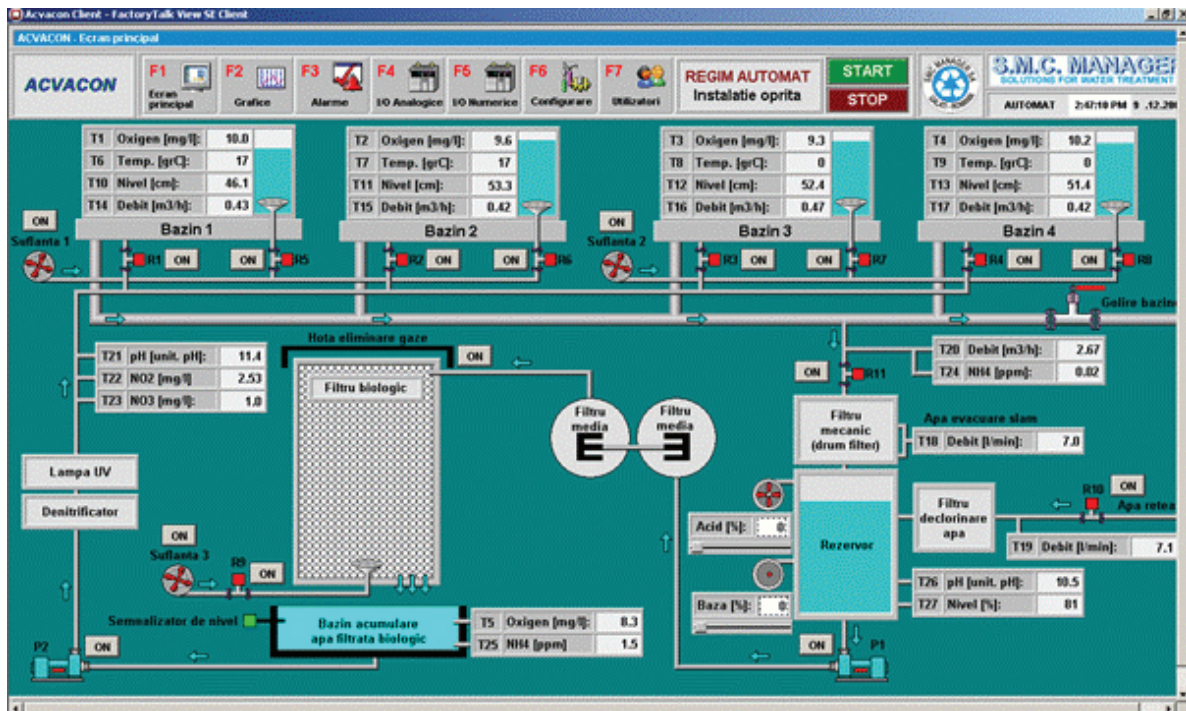

Figure 19. The main screen of the interface [14].

6. Conclusions

The performance of the biological filtering of the recirculated water in RAS has a crucial importance because it provides a proper hygienic and sanitary state of culture biomass. As a last resort, the ratio between the fish production and the culture space provided by RAS depends on this performance. The analysis of the pilot plant of RAS containing a trickling biofilter and a chemical denitrificator, made in "Dunarea de Jos" University of Galati, mainly targeted aspects of modeling, monitoring and control of the pilot station. It was confirmed experimentally that the biofilter aeration in countercurrent with respect to the flow of the processed water has a practical negligible effect so that the trickling biofilter does not offer control means of the nitrification process. In these conditions, the main possibility to control the nitrification process is the control of recirculated flow. The practical expertise from the operation of the pilot plant showed that the use of the recirculating pumps having a reduced cost, with constant flow and on-off control, is not an adequate solution in terms of energy consumption and mostly from the control necessities point of view. An alternative to this solution is the use of variable flow pumps, driven by frequency controlled asynchronous motors. An indirect control solution of the nitrification process that can be applied to reduce ammonia concentration at the biofilter output consists in the aeration intensification in aquaculture tanks.

The main difficulty of RAS control is generated by the disturbances that strongly affect all the system variables. These disturbances are produced by the washing processes of mechanical, sand and active carbon filters of RAS. Their presence makes difficult to discern the effects of control applied to the recirculating flow by the variations induced through internal disturbances. A possible solution, validated experimentally, consists in reducing these disturbances through the removal of sand and active carbon filters. It has been shown that their presence is not essential. In this case, the frequency of the internal disturbances, induced only by mechanical filter, is significantly reduced, having positive effects on the conditions in which the process control is carried out. The monitoring and control system of RAS provides, at the first hierarchical level, the local control loops of the process variables: water level, O₂ concentrations and pH. At the superior level, the process monitoring, its operating, and the control of nitrification process are achieved. Because of the high level of the system's disturbances, it was considered that the best solution for achieving these functions is to use an expert system.

An integrated modeling of RAS was performed, taking into account the phenomena that take place both in the biological subsystem of the fish population and at the level of the microbiological subsystem of the water quality. Thus, a distributed parameter system based on partial differential equations of the biofilm formation and substrate consumption and on reaction kinetics of ASM1 type was obtained. The model has been identified based on the experimental data taken from aquaculture pilot plant located in "Dunarea de Jos" University of Galati. This model was used as process emulator for a complete analysis of trickling biofilter. It allowed testing its behavior through numerical simulation in different situations, some of them being very difficult to obtain practically, because it could affect the fish biomass or even the microorganism population. This also allowed the treating of the biofilm through an adaptive filter, allowing the sensibility analysis of frequency models for each I-O channel.

Author details

Marian Barbu*, Emil Ceangă and Sergiu Caraman

*Address all correspondence to: marian.barbu@ugal.ro

"Dunărea de Jos" University of Galati, Department of Automatic Control and Electrical Engineering, Galați, România

References

- [1] Timmons M.B., Ebeling J.M. Recirculating aquaculture. 3rd Edition. Ithaca Publishing Company; Ithaca, NY 2013.

- [2] Ebeling J.M., Timmons M.B. Recirculating Aquaculture Systems. In: Tidwell J.H., editor. Aquaculture Production Systems. Wiley-Blackwell; Oxford; 2012.
- [3] Timmons M.B., Ebeling J.M. Recirculating Aquaculture. Cayuga Aqua Ventures; Ithaca, NY 2007.
- [4] Barbu M., Ionescu T., Ifrim G., Caraman S., Cristea V., Ceanga E. Results regarding the water quality control in recirculating aquaculture systems. *Journal of Environmental Protection and Ecology*. 2012; 13 (1): 39–47.
- [5] Wik T., Linden B., Wramner P. Integrated dynamic aquaculture and wastewater treatment modelling for recirculating aquaculture systems. *Aquaculture*. 2009; 287 (3–4): 361–370.
- [6] Wanner O., Eberl HJ., Morgenroth E., Noguera D., Picioreanu C., Rittmann BE., Van Loosdrecht M.C.M. *Mathematical Modeling of Biofilms*. IWA Publishing, London; 2006.
- [7] Barbu M., Mînză V., Carp D., Ceanga E. Identification and sensitivity analysis of a trickling biofilter viewed as a distributed parameters system. In: 15th International Conference on System Theory, Control and Computing, ICSTCC, Sinaia, Romania; 2011.
- [8] Reichert P. Design techniques of a computer program for the identification of processes and the simulation of water quality in aquatic systems. *Environmental Software*. 1995; 10 (3): 199–210.
- [9] Henze M., Gujer W., Mino T., van Loosdrecht M.C.M. *Activated Sludge Models ASM1, ASM2, ASM2d and ASM3*. IWA Publishing, London; 2000.
- [10] Barbu M., Picioreanu C. Model of trickling biofilter from an intensive recirculating aquaculture system. In: IWA Biofilm Conference: Processes in Biofilms, Shanghai, China; 2011.
- [11] Haykin S. *Adaptive Filter Theory*. Prentice Hall; Englewood Cliffs, NJ 1995.
- [12] Caraman S., Barbu M., Ionescu T., Ifrim G., Cristea V., Ceanga E. The analysis of the dynamic properties of the wastewater treatment process in a recirculating aquaculture system. *Romanian Biotechnological Letters*. 2010; 15 (4): 5457–5466.
- [13] Barbu M. Experimental results regarding the operating regimes of trickling filters in recirculating aquaculture systems. *Fresenius Environmental Bulletin*. 2012; 21 (11c): 3500–3506.
- [14] Barbu M., Caraman S., Vlad C., Nicolau T., Ceang E. Hierarchical control system for recirculating aquaculture processes. In: 16th International Conference on System Theory, Control and Computing, ICSTCC 2012, Sinaia, Romania; 2012.