

Theophilus Arthur

# **CONTROL STRUCTURE DESIGN FOR METHANOL PROCESS**

**Trondheim, June 2010**

Master thesis for the degree of MSc.

Norwegian University of Science and Technology

Faculty of Natural Sciences and Technology

Department of Chemical Engineering



**NTNU – Trondheim**  
Norwegian University of  
Science and Technology

## **Acknowledgements**

This project would not have been possible without the help and support of many people.

First and Foremost, I would like to express my sincere gratitude to the almighty God for seeing me through thick and thin times during my study at this wonderful institution.

Secondly, I would like to thank my supervisor Prof. Sigurd Skogestad for the continuous support he offered me during my MSc. studies, for his patience, motivation, enthusiasm, and immense knowledge. His guidance helped me in all the time of my research and writing of this thesis. I could not have imagined having a better advisor and mentor for my master program.

Besides my advisor, I would like to thank my co-supervisor Mehdi Panahi, for his encouragement, insightful comments, hard questions and for steering me towards the right direction all the time. My sincere thanks also go to Prof. Heinz Preisig, Prof. Magne Hillestad, Prof. Jens-Petter Andreassen and Lisbeth Roely, and all the other members of the department.

I thank my fellow international students Emmanuel Mba, Aderonke Adedeji, Trimaharika Widarena, and Bicheng Gao. Also I thank the Ghanaian community in Trondheim especially Miriam Peprah, Joseph Armoo, Noble Arden Nkuadey and all the rest for their support and advice.

Last but not the least; I would like to thank my family: my wife Joyce Asare Arthur and my parents John Yalley-Arthur and Helena Eshun, for giving birth to me at the first place and supporting me spiritually throughout my life.

## Abstract

This thesis studies the self-optimizing control for a methanol plant. Natural gas was considered as the raw material for the process simulation, since it is of special interest in Norway for both economic and political point of view. Different technologies which are applied in practice for the production of the mentioned petrochemical were also studied in the literature review of this project.

The three main parts in the production of methanol namely; synthesis gas production, methanol synthesis and purification has been simulated using UniSim™. Autothermal reforming (ATR) technology was used for the production of the synthesis gas since it is one of the best ways of producing methanol in large capacities. The methanol synthesis part which is of importance amongst the three for this project was simulated by using the kinetics studied by Froment and Vanden Bussche in a fixed bed reactor (Lurgi technology).

The UniSim™ process simulator was also used for the optimization of the process in only mode I of self-optimizing control method proposed by Skogestad where the feed rate is given. Some of the degrees of freedom considered during the process optimization include flow rates of water and oxygen relative to methane in the feed, pressure at the synthesis gas and methanol synthesis section, recycle flows (which includes unconverted syngas to the methanol reactor and pure hydrogen from the pressure adsorption swing to the make-up gas compressor) and also outlet temperature of the fired heater. Some of the operational constraints were the recycle ratios, maximum and minimum temperatures, minimum stream to carbon ratios, and minimum amount of the product. The operational objective function for the optimization was the carbon efficiency which is an important operating parameter for overall energy efficiency defined as the measure of how much carbon in the feed is converted to methanol product. Next the process was optimized when various disturbances occur (such as the feed flow rate, feed composition and temperature).

One of the main themes of the project which is identifying the self-optimizing variables (which are controlled variables which indirectly give close to optimal operation when held at constant setpoints, despite changes in the disturbance variables) for the process. Only one of the constraints was found to be active and that was the outlet temperature of fired heater. The self-optimizing variables identified for this process includes flowrate of water, outlet temperature of fired heater, pressure at both the syngas and methanol part, recycle of unconverted syngas to the methanol reactor and recycle of pure hydrogen to the make-up gas. The just mentioned variables can be kept constant except the flowrate of oxygen when disturbances occur.

The effect of implementation error was also considered and it was found that it has a major impact on the pressure of the methanol synthesis section and also the split ratio between the recycle flow to the methanol reactor and the purge stream. The exact local method was used to find the best candidate sets of control variables for the unconstrained manipulated inputs mentioned above. The best set was to use the make-up gas compressor power to control pressure to the methanol reactor and the flowrate of the purge gas is flow controlled.

A plantwide control structure was proposed for the methanol process. However, because of the instabilities of the process, it became very difficult to test the effectiveness of the control structure. The dynamics of the process in UniSim™ failed when the whole plant was analysed but seems to work fine when they are separated that is the synthesis gas part and the methanol synthesis part. One of the major problems was the control of the outlet temperature of the methanol reactor, since it became difficult to control it, its impact on the objective function was very great.

## Table of Contents

Acknowledgements.....	i
Abstract.....	- 1 -
List of figures.....	- 1 -
List of tables.....	- 1 -
Nomenclature .....	- 1 -
Chapter 1.....	- 1 -
Introduction .....	- 1 -
1.1 Background motivation .....	- 1 -
1.4 Aims.....	- 7 -
1.5 Outline .....	- 7 -
Chapter 2.....	- 9 -
Literature Survey of the Methanol Process .....	- 9 -
2.1 Methanol Production Technology .....	- 9 -
2.2 Synthesis gas production .....	- 10 -
2.3 Reactions and thermodynamics of synthesis gas production .....	- 11 -
2.4 Production of methanol technologies .....	- 12 -
2.5 Methanol reactor.....	- 16 -
2.6 Thermodynamics and Kinetics of methanol synthesis .....	- 16 -
2.7 Procedure for control structure design for chemical plants.....	- 24 -
Chapter 3.....	- 30 -
Methanol Process Description .....	- 30 -
3.1 Pre-reforming.....	- 30 -
3.2 Autothermic reaction .....	- 31 -
3.3 Separation process .....	- 31 -
3.4 Compression .....	- 32 -
3.5 Methanol synthesis .....	- 32 -
3.6 Purification .....	- 33 -
3.7 Details of the methanol process model in UniSim™ .....	- 34 -
Chapter 4.....	- 39 -
Results and Discussion .....	- 39 -

4.1 Self-optimizing control.....	- 40 -
4.1.1 Step 1: Degree of freedom analysis.....	- 40 -
4.1.2 Step 2: Definition of optimal operation.....	- 41 -
4.1.3 Step 3: Optimization.....	- 41 -
4.1.4 Step 4: Identification of important disturbances.....	- 42 -
4.1.5 Step 5: Identification of candidate control variables.....	- 47 -
4.1.6 Step 6: Detailed evaluation of loss.....	- 48 -
4.2 Dynamic Simulation.....	- 50 -
4.2.2 Tuning of controllers.....	- 51 -
Chapter 5.....	- 57 -
Conclusion and further work.....	- 57 -
5.1 Conclusion.....	- 57 -
5.2 Future Recommendation.....	- 58 -
REFERENCES.....	- 60 -
APPENDIX.....	- 62 -

## List of figures

Figure.1.1: Norway Natural gas production and consumption, 1987 - 2007 .....	- 2 -
Figure2.1: Autothermal reformer .....	- 11 -
Figure2.2: Flow sheet of Lurgi low-pressure methanol process, [14] .....	- 13 -
Figure2.3: Flow scheme of the low-pressure methanol process, [12].....	- 14 -
Figure2.4: Flow scheme of the reaction section of the Haldor Topsøe methanol process, [12] .....	- 14 -
Figure2.5: Mitsubishi Gas Chemical low-pressure methanol synthesis process, [14].....	- 15 -
Figure2.6: Typical control layer for a chemical plant.....	- 25 -
Figure3.1: Process flowsheet for methanol production.....	- 30 -
Figure3.2: Methanol UniSim™ process flowsheet.....	- 36 -
Figure4.1: Steady-state concentrations with varying temperature (P = 76.98bar).....	- 39 -
Figure4.2: Steady-state concentration with varying pressure (T = 270°C).....	- 40 -
Figure4.3: Change in natural gas flow rate .....	- 43 -
Figure4.4: change in natural gas composition .....	- 44 -
Figure4.5: Change in outlet temperature of fired heater .....	- 45 -
Figure4.10: Plant wide control structure.....	- 55 -
Figure4.6: Setpoint of control variables.....	- 51 -
Figure4.7: 10% decrease in natural gas flowrate .....	- 52 -
Figure4.8: 10% increase in natural gas flowrate.....	- 53 -
Figure4.9: 5% change in natural gas composition .....	- 54 -

## List of tables

Table1.1: Typical composition of Natural Gas [20] .....	- 1 -
Table1.2: Properties of methanol [15] .....	- 3 -
Table1.3: Feedstocks, processes and catalysts for the production of syngas and methanol [15].....	- 4 -
Table 2.1: Reactions during methane conversion with steam and/or oxygen [12] .....	- 12 -
Table 2.2: CO and CO <sub>2</sub> equilibrium conversion data [12].....	- 17 -
Table2.3: Role of CO <sub>2</sub> in methanol synthesis as reported by several authors .....	- 18 -
Table2.4: The experimental conditions used by Klier et al (1982).....	- 20 -
Table2.5: The operating conditions used by Graaf et al (1988a).....	- 21 -
Table2.6: The operating conditions used by Vanden Bussche and Froment (1996).....	- 22 -
Table2.7: The operating conditions used by Ledakowicz et al (1992) .....	- 22 -
Table2.8: The operating conditions used by Skrzypek et al. (1991).....	- 23 -
Table2.9: Typical number of steady-state degrees of freedom for some process units .....	- 24 -
Table3.1: Pre-reforming reactions .....	- 31 -
Table3.2: Reactions occurring in the ATR reactor .....	- 31 -
Table3.3: Kinetic and equilibrium data.....	- 33 -
Table3.4: Catalyst and reactor data.....	- 33 -
Table3.5: Natural gas composition .....	- 34 -
Table4.1: List of manipulated variables.....	- 41 -
Table4.2: Disturbances to the process.....	- 42 -
Table4.3: Summary of worst case losses for various disturbances.....	- 46 -
Table4.4: Effect of CV implementation error on objective function (loss) .....	- 46 -
Table4.5: Selected candidate control variables for the methanol process.....	- 48 -
Table4.6: Candidate control variables with small losses in local analysis.....	- 49 -
Table4.7: Maximum singular values for unconstrained control variables .....	- 50 -
Table4.8: Controller parameters .....	- 56 -



## Nomenclature

Symbol	Definition	Unit
$u$	Base set for unconstrained degree of freedom	
$d$	Disturbance variables	
$J_{ud}$	Cost for a given $u$ and $d$	
$J_{uu}$	Cost function for a given (Hessian)	
$L = J - J_{opt}(d)$	Loss	
$u_{opt}(d)$	Optimal value of $u$ for given $d$	
$y$	Measured variable	
$G$	Steady-state gain matrix	
$e_c = c' - c'_{opt}$	Deviation from optimal $c$	
$\sigma(S_1 G)$	Minimum singular value	
$\sigma(\mathbf{M})$	Maximum singular value	
$S_I$	Matrix of scaling for $c_i$	
$x$	Internal variables (states)	
$W_d$	Expected magnitude of individual disturbances	
$W_n$	Magnitude of implementation error	
$\Delta H$	Enthalpy of reaction	kJ/mol
$\Delta G$	Gibbs energy	kJ/mol
$\Delta S$	Entropy	J/kmol
$B$	Activation energy	
$R_g$	Universal gas constant	kJ/kmol K
$R$	Recycle rate	kmol/kmol
$A$	Frequency factor for reaction	
$c_p$	Specific heat of the gas at constant pressure	J/mol
$D_i$	Tube inside diameter	m
$P_i$	Partial pressure of component $i$	kPa
$F_{MeOH}$	Molar flowrate of methanol	ton/day
$K_i$	Adsorption equilibrium constant for component $i$	bar <sup>-1</sup>
$r_i$	Rate constant for methanol reaction, where $i = A, B$	mol/kg sbar <sup>-1/2</sup>
$T$	Temperature	K
$\rho_b$	Density of catalytic bed	kg/m <sup>3</sup>

## Chapter 1

### Introduction

This thesis presents a Master of Science degree project conducted at the department of Chemical Engineering, at NTNU. The thesis studies the simulation, optimization and control structure design using stepwise approach of Skogestad.

#### 1.1 Background motivation

##### 1.1.1 Natural gas as raw material

Natural gas is becoming one of the vital components of the world's supply of energy. It is one of the cleanest, safest and most useful of all energy sources. Although we cannot say it is 100% safe, since it also emits lower levels of potentially harmful by-products into the air after burning. The composition of natural gas can vary but below is a chart displaying the typical makeup of natural gas before it is sent for refining.

**Table1.1: Typical composition of Natural Gas [20]**

Methane	CH <sub>4</sub>	70-90%
Ethane	C <sub>2</sub> H <sub>6</sub>	
Propane	C <sub>3</sub> H <sub>8</sub>	
Butane	C <sub>4</sub> H <sub>10</sub>	0-20%
Carbon Dioxide	CO <sub>2</sub>	0-8%
Oxygen	O <sub>2</sub>	0-0.2%
Nitrogen	N <sub>2</sub>	0-5%
Hydrogen sulphide	H <sub>2</sub> S	0-5%
Rare gases	Ar, He, Ne, Xe	trace

Norway in particular has generated some special interest in the conversion of natural gas for both economic and political reasons. According to the OGJ, Norway had 81.7 trillion cubic feet (Tcf) of proven natural gas reserves as of January 2009 [21]. Norway produced about 3.5 Tcf of natural gas in 2008 and the production has been increasing since 1994. The main option for the

## Control Structure Design for Methanol Process

use of this natural gas produced in this country is for export to Europe via pipelines, power production and conversion to other petrochemicals like methanol. The country is the second-largest supplier of natural to the European Union, behind Russia.

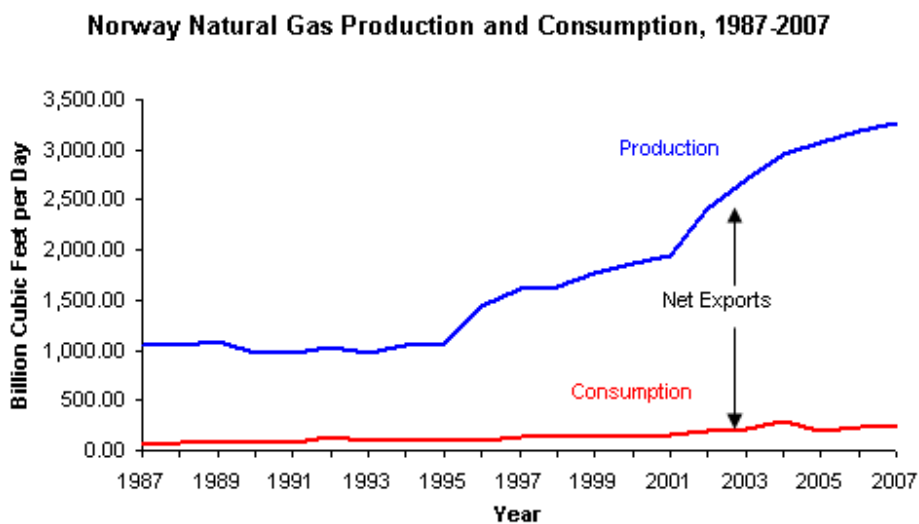

**Figure.1.1: Norway Natural gas production and consumption, 1987 - 2007**

### 1.1.2 Methanol

Methanol also known as methyl alcohol or wood alcohol is a colourless, water-soluble liquid with mild alcoholic odour. It freezes at  $-97.6^{\circ}\text{C}$ , boils at  $64.6^{\circ}\text{C}$  and a density of  $791\text{kg/m}^3$  at  $20^{\circ}\text{C}$ . It is polar, acid-base neutral, and generally considered non-corrosive. It is miscible with most organic solvents and is capable of dissolving many inorganic salts.

Methanol can be produced from a variety of sources including natural gas, coal, biomass and petroleum. Some properties of methanol are shown in table 1.2.

## Control Structure Design for Methanol Process

---

**Table1.2: Properties of methanol [15]**

Synonyms	Methyl alcohol, wood alcohol
Chemical formular	CH <sub>3</sub> OH
Molecular weight	32.04
Chemical composition (%)	
Carbon	37.5
Hydrogen	12.5
Oxygen	50
Melting point	-97.6°C
Boiling point	64.6°C
Density at 20°C	791kg/m <sup>3</sup>
Energy content	5420 kcal/kg
	173.2 kcal/mol
Energy of vapourization	9.2 kcal/mol
Flash point	11°C
Explosive limits in air	7 – 36%
Auto ignition temperature	455°C

---

Table 1.3 summarizes the processes, feedstocks and catalysts for the production of methanol and its precursor syngas. Synthesis of methanol takes place industrially via syngas.

## Control Structure Design for Methanol Process

**Table1.3: Feedstocks, processes and catalysts for the production of syngas and methanol [15]**

Feedstocks	Process and main reactions	Catalysts
Formation of syngas		
Natural gas	Steam reforming: $\text{CH}_4 + \text{H}_2\text{O} \leftrightarrow \text{CO} + 3\text{H}_2$	Ni on $\text{Al}_2\text{O}_3$
Natural gas	Autothermal reforming: $\text{CH}_4 + 2\text{O}_2 \leftrightarrow \text{CO}_2 + 2\text{H}_2\text{O}$ Then $\text{CH}_4 + \text{H}_2\text{O} \leftrightarrow \text{CO} + 3\text{H}_2$ $\text{CO}_2 + \text{H}_2 \leftrightarrow \text{CO} + \text{H}_2\text{O}$	- Ni on refractory supports
Natural gas	Partial oxidation: $\text{CH}_4 + 1/2\text{O}_2 \rightarrow \text{CO} + 2\text{H}_2$	Non-catalytic or lanthanide/Ru Supported by Ru, Ni, Pd
Coal	Gasification (in the presence of $\text{H}_2\text{O}/\text{O}_2$ )	-
Biomass	Gasification	-
Others(e.g.liquefied petroleum gas, naphtha, heavy fuel oil)	Steam reforming (light hydrocarbons)	Alkalized Ni on $\text{Al}_2\text{O}_3$ or on Ca/ $\text{Al}_2\text{O}_3$
Formation of methanol		
Syngas	Methanol synthesis $\text{CO} + 2\text{H}_2 \leftrightarrow \text{CH}_3\text{OH}$ $\text{CO}_2 + 3\text{H}_2 \leftrightarrow \text{CH}_3\text{OH} + \text{H}_2\text{O}$	Cu/ZnO/ $\text{Al}_2\text{O}_3$ Cu/ZnO/ $\text{Cr}_2\text{O}_3$ /ZnCr
Syngas	Two-step methanol synthesis: $\text{CH}_3\text{OH} + \text{CO} \leftrightarrow \text{HCOOCH}_3$ , then	Potassium methoxide

## Control Structure Design for Methanol Process

---

	$\text{HCOOCH}_3 + 2\text{H}_2 \leftrightarrow 2\text{CH}_3\text{OH}$	Cu chromite
Methane	Direct oxidation: $\text{CH}_4 + 1/2\text{O}_2(\text{N}_2\text{O}) \leftrightarrow \text{CH}_3\text{OH}$	
Methane	Bioprocessing	Metal oxides (eg $\text{MoO}_3$ based)  Enzymes (eg cytochrome $\text{P}_{450}$ ), methanotrophs.

**Table 1.3: Feedstocks, processes and catalysts for the production of syngas and methanol [15] (cont'd)**

Methanol can be used as a fuel or fuel additive (e.g. neat methanol fuel, methanol blended with gasoline, MTBE, TAME and methanol to gasoline). It can also be used for the production of chemicals like formaldehyde, acetic acid, chloromethanes, methyl methacrylate, dimethyl terephthalate, methyl amines, and glycol methyl ethers. It is also used as a solvent for windshield, antifreeze, inhibitor to hydrate formation in natural gas processing and as a substrate for crop growth.

### **1.1.3 Steady State Simulation**

Simulations done in steady state has been used more often in the process industry for the design, analysis and optimization of chemical processes. The material and energy balance data for a process flow are also provided by this type of simulation. The use of equations in steady-state models defines the relationships between elements of the modelled system and attempts to find a state in which the system is in equilibrium. Such models do not consider the transient behaviour of the process; they are therefore used at the early stages of conceptual design, feasibility studies, detailed engineering and the initialization stages for dynamic simulations which are used in studying how the process changes with time.

These models are usually made up of blocks of unit operations put together by the user and physical data for each chemical component of the input stream. The amount information needed from the user is for the input streams to run the simulation is very minimal. In this project the steady state simulation was purposely used for the optimization and evaluation of the performance of the plant.

## Control Structure Design for Methanol Process

---

### ***1.1.4 Dynamic state simulation***

Simulation dynamics has grown to be a necessary tool in the process industry over the last decade. It is mainly used to improve unit yields, plant stability, safety and controllability. Such kind of simulations is able to predict how the process changes with time and also assist in the evaluation and design of the control structures for a particular process. It can be categorized into two type's namely empirical and first principle models. Empirical models are based on black box model approach. This type of model is stacked with a number of regressions of the input/output responses. Multivariable regression, fuzzy logic systems and neural networks are typical examples of such type of model. The downside of this type of model is the handling of wide range operating conditions for which the model is regressed. The first principal models are the ones developed from the fundamental equations for the mass, energy and momentum balances; diffusive and heat transport; chemical kinetics and reaction mechanisms; thermodynamics and phase equilibrium. The process is represented in terms of Ordinary Differential Equations (ODE) or Algebraic Equations. The equations are solved based on the techniques of numerical integration over time to predict the dynamic behaviour of the process in response to various predicted and unpredicted disturbances.

Dynamic modelling helps in the better designing, optimization and operation of a chemical process or refining plant. It is never true that a real plant operates in steady-state. There are certain disturbances that occur in real plants for example feed and environmental disturbances, heat exchanger fouling and catalytic degradation which constantly upset the conditions for smooth running of the process are not accounted for in the steady-state mode. The study of the transient behaviour of the process is the only way to show how the plant functions in real life; dynamic simulating software like UniSim™ can be used to approximate the transient behaviour of the process.

Dynamic simulation assures us that the plant can produce the desired products in a manner that is safe and easy to operate. There are certain features in the simulating tool that allows you to specify the size of equipment and also it is possible to verify the equipment function as expected in the actual plant situation. Offline dynamic simulation can aid in the design of controller optimization without adversely affecting the profitability or safety of the plant. It is also possible

# Control Structure Design for Methanol Process

---

to design and test different control strategies and then choose the best for implementation. Dynamic response to system disturbances and also optimal tuning of controllers can be examined. Dynamic analysis gives feed-back and improves the steady-state model by pinpointing specific areas in the plant that have difficulty achieving the objectives set out in steady-state. It is also possible to investigate:

- Process optimization
- Controller optimization
- Safety evaluation
- Transition between operating conditions
- Start-up/shutdown conditions

## 1.4 Aims

The sole purpose of this thesis is to use the systematic method described in [26] to design control structure for the methanol process. Based on the procedure we first find the control variables by using the self-optimizing control approach. A control structure to the process is to be developed for the process and this structure is validated by using dynamic simulation. More details of the procedure are described in the next chapter.

## 1.5 Outline

Part of this thesis is from my previous project work. It is written in the form a book with references, appendix and notation list.

**Chapter 2** gives an overview of the literature survey of the methanol process and the idea of self-optimizing control

**Chapter 3** describes the detailed design of the methanol process with process flow diagrams and also the review of the UniSim™ simulation



## Control Structure Design for Methanol Process

---

**Chapter 4** elaborates on the results and discussion obtained as a result of the simulation and optimization obtained from the process.

**Chapter 5** concludes the work done in this thesis and also the future work to be done on the topic.

## Chapter 2

### Literature Survey of the Methanol Process

The chapter introduces how methanol is manufactured from the process industries, the kinetics of the process and most importantly how the synthesis gas is manufactured.

#### 2.1 Methanol Production Technology

All commercial methanol technologies is made up of three process sections as listed below:

- Synthesis gas preparation
- Methanol synthesis
- Methanol purification

When designing a methanol plant this process sections can be considered independently, and it is possible to select each technology separately for optimization. Capital cost and the efficiency of the plant is the normal criteria used in the selection of a particular technology. The synthesis gas preparation and compression typically accounts for about 60% of the investment, and almost all energy is consumed in this process section [23]. Therefore the selection of reforming technology is very important, regardless of the plant location. The synthesis gas used for the production of methanol is characterized by what is called the module (M) of the synthesis gas which is defined by the stoichiometric ratio  $(H_2 - CO_2) / (CO + CO_2)$ . A model of 2 defines a stoichiometric synthesis gas for the formation of methanol [23]. Some relevant properties of the syngas for the formation of methanol are the CO to CO<sub>2</sub> ratio and the concentration of inerts. The achievable per pass conversion and the rate of reaction increases if the CO to CO<sub>2</sub> is very high. This also reduces the formation of water and the rate of deactivation of the catalyst also decreases. If the inert concentration in the syngas is very high it affects the partial pressure of the active reactants and thereby reducing the rate of reaction. Typical inerts in the methanol synthesis are methane, argon and nitrogen.

## 2.2 Synthesis gas production

Synthesis gas (syngas) is a general term used in describing a mixture hydrogen and carbon monoxide (CO) in different ratios and can be generated from any hydrocarbon feedstock. Synthesis gas can be produced from a large variety of materials which includes natural gas, naphtha, residual oil, petroleum coke, biomass and coal. The most material applicable in the production of methanol is natural gas. The production of syngas occupies the major investment cost of GTL plants. The principal technologies used for the production of syngas are summarized below;

### i) **SMR**

This technology has been the most predominantly used commercially in which steam and methane are converted catalytically and endothermically to hydrogen and carbon monoxide. After the desulphurization of the natural gas feed, the product is mixed with steam (optionally CO<sub>2</sub>) and then preheated to about 780K before it enters the reformer tubes. The heat for the endothermic reforming reaction is supplied by the combustion of fuel in the reformer furnace (allothermic operation), [12]. The hot effluent gas exiting the reformer is used for the production of steam. A separator is used in separating water from the syngas by gravitation and the raw syngas is treated further depending on its use.

### ii) **Heat-Exchange reforming**

Large amount of heat is required in the steam reformer and the autothermic reformer (ATR) also produces heat, an advanced technology suggests that the heat from the ATR is used to supply the heat input needed by the steam reformer and this process is known as the heat-exchange reforming or gas-heated reforming. The major advantage of this is the reduction in investment cost by eliminating the expensive fired reformer. The consequence of this process is that only medium pressure steam can be generated and large electrical power will be needed for the driving of the syngas compressor.

### iii) **Autothermic reforming (ATR)**

Addition of oxygen to the steam reforming process is an alternative measure in obtaining lower H<sub>2</sub>/CO ratio. Autothermic reforming is the reforming of light hydrocarbons in a

## Control Structure Design for Methanol Process

mixture of steam and oxygen in the presence of a catalyst [12]. The reactor is designed with a refractory lined vessel, therefore higher temperature and pressure can be applied than in steam reforming. ATR cannot be used alone; therefore a pre-reformer is installed downstream where typically 35 to 45% of the reforming reaction occurs [12]. The ATR converts the remaining methane from the pre-reformer. Air is used to supply the required oxygen.

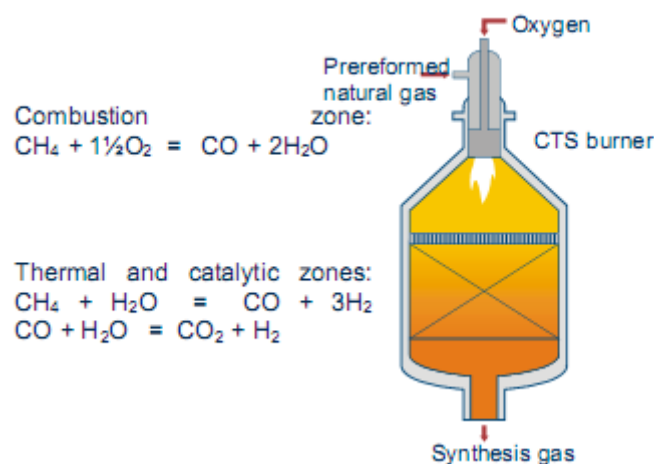

Figure2.1: Autothermal reformer

A reactivity of the synthesis gas produced from the autothermal reforming occurs due to the amount of carbon monoxide present. This synthesis gas produced has a module of 1.7 to 1.8, implying that it is deficient in hydrogen [23]. This gas is therefore unsuitable for the production of methanol and an adjustment to a module of around 2 is needed. This adjustment is either done by removing carbon dioxide from the synthesis gas or recovering hydrogen from the synthesis loop purge gas and recycling the recovered hydrogen to the synthesis gas [23].

### 2.3 Reactions and thermodynamics of synthesis gas production

Natural gas is predominantly made up of methane and for simplicity it will be used in describing the various reactions occurring in steam reforming. The table below shows the various reactions;

# Control Structure Design for Methanol Process

**Table 2.1: Reactions during methane conversion with steam and/or oxygen [12]**

Reaction	$\Delta H_{298}^0 \left( \frac{kJ}{mol} \right)$
$CH_4 + H_2O \leftrightarrow CO + 3H_2$	206
$CO + H_2O \leftrightarrow CO_2 + H_2$	-41
$CH_4 + CO_2 \leftrightarrow 2CO + 2H_2$	247
$CH_4 \leftrightarrow C + 2H_2$	75
$2CO \leftrightarrow C + CO_2$	-173
$CH_4 + 1/2O_2 \rightarrow CO + 2H_2$	-36
$CH_4 + 2O_2 \rightarrow CO_2 + 2H_2O$	-803
$CO + 1/2O_2 \rightarrow CO_2$	-284
$H_2 + 1/2O_2 \rightarrow H_2O$	-242

## 2.4 Production of methanol technologies

### 2.4.1 Lurgi low-pressure methanol synthesis process

The process developed by Lurgi Corporation for the synthesis of methanol is made up of a reactor operating at a temperature of 250 - 260°C and a pressure of 50 – 60bar. The reactor is a shell and tube type with the catalysts filled in the tubes. The heat of reaction is removed by circulating cold water on the shell side and this generates high pressure steam for other usage. Feedstock for the production of syngas includes gaseous hydrocarbons such as methane as well as liquid hydrocarbons like naphtha. The syngas can be produced via two routes namely steam reforming and partial oxidation. Steam reforming is carried out at temperatures of 850 - 860°C. Desulphurized naphtha is contacted with steam at this temperature to produce hydrogen and carbon oxides. The syngas produced is compressed to 50 – 80bar before it is fed into the methanol reactor. For the second route, heavy residues are fed into a furnace along with oxygen and steam at 1400 - 1450°C and the operating pressure is at 55 – 60bar and this does not require any further compression. Below is the flow scheme for the process;

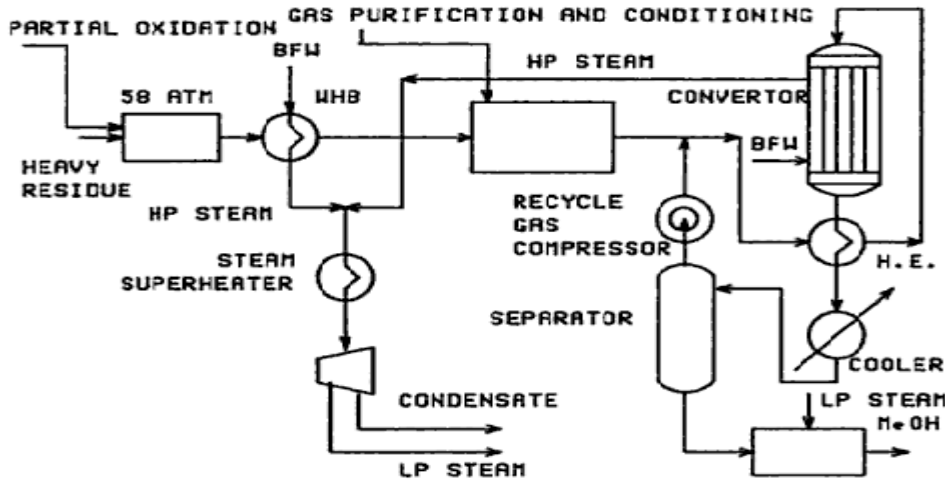

Figure 2.2: Flow sheet of Lurgi low-pressure methanol process, [14]

### 2.4.2 ICI low-pressure methanol process

This process utilizes the use of an adiabatic reactor and a single catalyst bed. The heat of reaction is removed or quenched by introducing cold reactants at different heights of the catalyst bed. First of all fresh synthesis gas which is compressed and mixed with recycled gas is heated by heat exchange with the reactor effluent. Then about 40% of the stream is sent to the reactor after undergoing supplementary preheating also by the reactor effluent [12]. Then the rest is used as a quench gas for removing the heat of reaction. The products emanating from the reactor is cooled by heat exchanged with the feed and water for the generation of high pressure steam. It is further cooled with an air-cool heat exchanger in which methanol and water are condensed. The separation of gas/liquid takes place in a flash drum under pressure. The gas is recycled after purging small part to keep the inerts level in the loop within limits [12]. Purification of the methanol is done in two different columns. The first column removes gases and other light impurities while the second separates methanol from other heavy alcohols. Below is the process flow diagram;

# Control Structure Design for Methanol Process

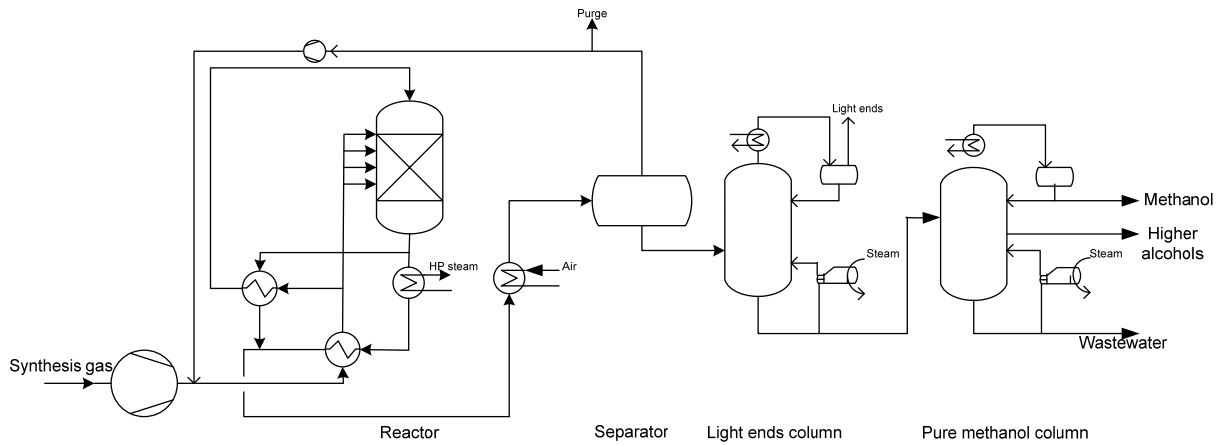

Figure2.3: Flow scheme of the low-pressure methanol process, [12]

## 2.4.3 Haldor Topsøe methanol process

This process uses several adiabatic reactors arranged in series and the heat of reaction is removed by intermediate coolers. The synthesis gas flows radially through the catalyst bed and this reduces pressure drop as compared to axial flow [1]. The purification is the same as the other processes. The flow scheme is shown below;

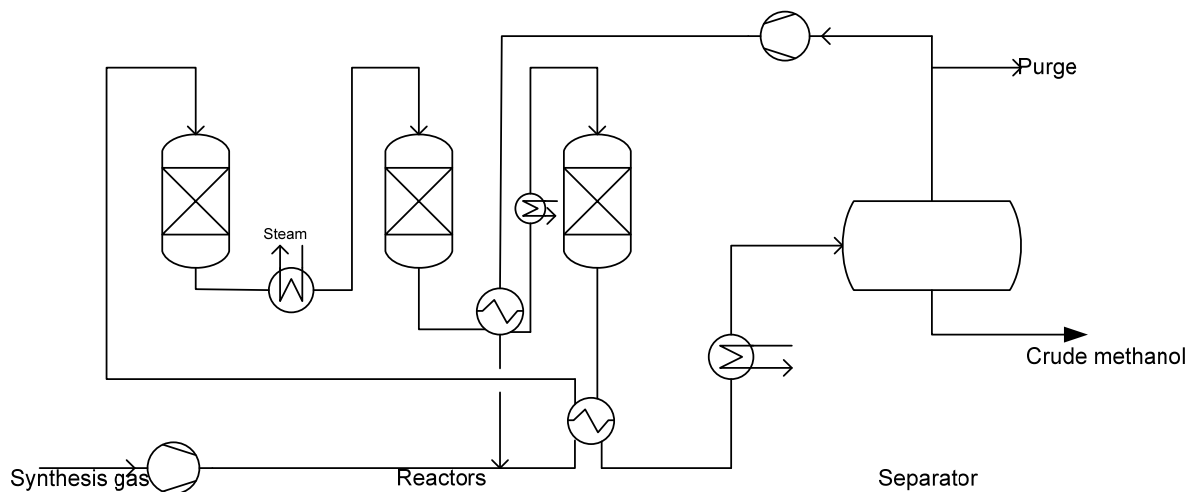

Figure2.4: Flow scheme of the reaction section of the Haldor Topsøe methanol process, [12]

# Control Structure Design for Methanol Process

## 2.4.4 The MGC low-pressure process

The flow scheme below shows the process developed by Mitsubishi Gas Chemical Company. It uses copper-based methanol synthesis catalyst. It operates at temperatures ranging from 200 - 280°C over a pressure range of 50 – 150 atm. The temperature of the catalyst bed is kept under control by using quench type converter design, and also some of the heat of reaction is recovered in an intermediate stage boiler. This process utilizes hydrocarbon as feedstock. The raw material is desulphurised and then fed into a steam reformer at 500°C. The exit stream from the reformer contains hydrogen, carbon monoxide and carbon dioxide at 800 - 850°C. The gases are compressed in a centrifugal compressor and mixed with the recycle stream before being fed into the converter. The

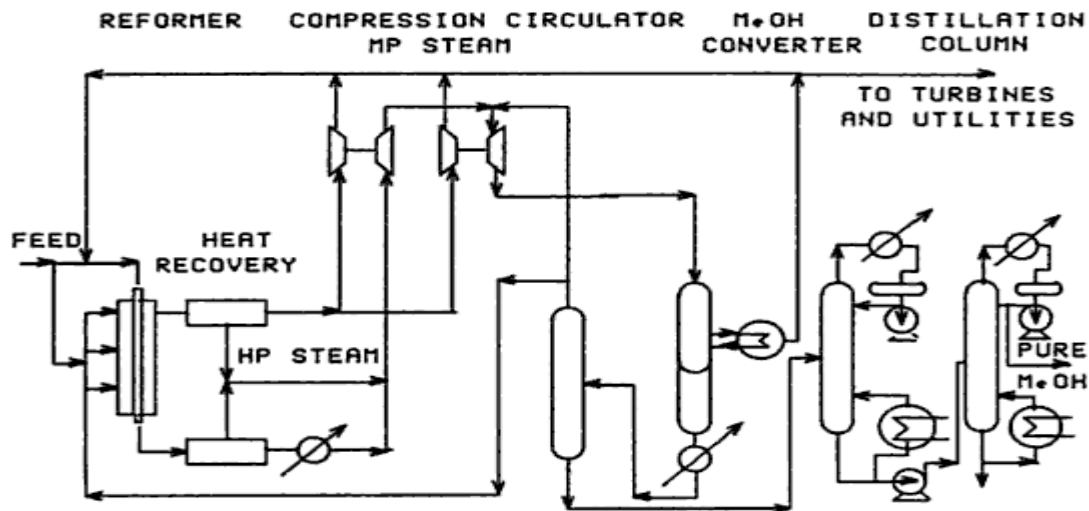

Figure 2.5: Mitsubishi Gas Chemical low-pressure methanol synthesis process, [14]



# Control Structure Design for Methanol Process

---

## 2.5 Methanol reactor

Different designs of methanol synthesis reactors have been used:

- Quench reactor
- Adiabatic reactors in series
- Boiling water reactors (BWR)

A **quench reactor** is made up of a number of adiabatic catalyst beds installed in series in one pressure shell [23]. Practically, up to five catalyst beds have been used. The feed entering the reactor is divided into several fractions and distributed to the several catalyst beds.

If **adiabatic reactors** are used in the synthesis loop, it is normally made up of a number (2 – 4) fixed beds placed in series with cooling between the reactors. The cooling is achieved in several ways including preheating of high pressure boiler feed water, generation of medium pressure steam, and/or by preheat of feed to the first reactor. This system features good economy of scale and also the mechanical simplicity contributes to the low investment cost.

The **BWR** is a shell and tube heat exchanger with the catalysts installed on the tube side in principle. Cooling takes place by providing boiling water on the shell side. By controlling the pressure of the circulating boiling water, the temperature of the reaction is controlled and optimized. The steam generated can be used to drive the compressors and subsequently as distillation steam. This type of reactor is nearly isothermal, and this gives a high conversion compared to the amount of catalyst installed. The reaction rate depends on the operating temperature of the reactor, and this might be between 240°C - 260°C.

## 2.6 Thermodynamics and Kinetics of methanol synthesis

The three main reactions for the formation of methanol from synthesis gas is made up of hydrogenation of CO, hydrogenation of CO<sub>2</sub> and the reverse water-gas shift reaction. The reaction proceeds as follows;

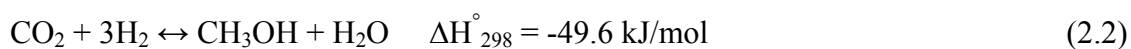
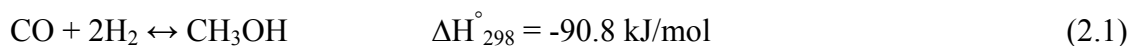

## Control Structure Design for Methanol Process

---

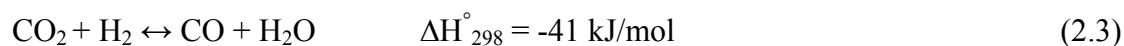

The table below shows the equilibrium data for the methanol forming reactions:

**Table 2.2: CO and CO<sub>2</sub> equilibrium conversion data [12]**

Temp. (K)	CO conversion			CO <sub>2</sub> conversion		
	Pressure (bar)			Pressure (bar)		
	50	100	300	10	100	300
525	0.524	0.769	0.951	0.035	0.052	0.189
575	0.174	0.440	0.825	0.064	0.081	0.187
625	0.027	0.145	0.600	0.100	0.127	0.223
675	0.015	0.017	0.310	0.168	0.186	0.260

During the CO hydrogenation other products can be formed such as higher alcohols and hydrocarbons. The figure below shows some thermodynamic data for the synthesis of methanol and also some possible by-products formed as a result of the reaction between CO and H<sub>2</sub>, with water as a by-product. The figure clearly shows that methanol is less stable and it is less likely to be formed in the reaction between CO and H<sub>2</sub>, some of the products formed is methane through the methanation reaction. The selectivity of the catalyst is very important during the methanol process. The selectivity of modern catalyst CuO/ZnO/Al<sub>2</sub>O<sub>3</sub> is over 99%.

The literature on the kinetic studies of methanol is thoroughly reviewed in this section. Different kinetic models with the corresponding operating conditions are also presented. Although methanol synthesis is an important industrial process and has been a commercial process since 1923, the kinetic studies and reaction mechanisms in open literature are often conflicting (Rozovskii et al. 2003).

The role of CO<sub>2</sub> is most often than not insufficiently understood. Most models published nowadays either states that methanol is produced from CO only or CO<sub>2</sub> only. The table below displays the conflicts that existed between the 50's and 80's.

## Control Structure Design for Methanol Process

**Table 2.3: Role of CO<sub>2</sub> in methanol synthesis as reported by several authors**

Authors	Carbon source for methanol	Adsorption of CO <sub>2</sub>	Catalyst
Natta (1955)	CO	-	Zn-Cr
Bakemeier et al. (1970)	CO	Yes	Zn-Cr
Leonov et al. (1973)	CO	No	Cu-Zn-Al
Schermuly and Luft (1977)	CO	Yes	Cu-?
Denise and Sneed (1982)	CO + CO <sub>2</sub>	-	Cu-Zn-Al
Klier et al. (1982)	CO + CO <sub>2</sub>	Yes	Cu-Zn
Monier et al. (1984)	CO	Yes	Cu-Cr
Chinchen et al. (1984)	CO <sub>2</sub>	Yes	Cu-Zn-Al
Villa et al. (1985)	CO	Yes	Cu-Zn-Al
Liu et al. (1985)	CO + CO <sub>2</sub>	Yes	Cu-Zn
Seyfert and Luft (1985)	CO	Yes	Cu-Zn
Dybkjaer (1985)	CO <sub>2</sub>	Yes	Cu-Zn-Al, Cu-Zn-Cr

Others also believed that it is primarily produced from the hydrogenation of CO<sub>2</sub> (Skrzypek et al. 1995, Coteron and Hayhurst 1994, Vanden Bussche and Froment 1996, Šetinc et al. 1999, Wu et al. 2001). Šetinc et al. (1999) states that the role of CO is to remove the absorbed oxygen from the catalyst surface, which results in the reaction between CO<sub>2</sub> and H<sub>2</sub>.

The studies made on the kinetics varies due to the reaction conditions (temperature and pressure), feedstock and catalyst used. Some models derive the rate expressions from the synthesis of CO and H<sub>2</sub> while others take into consideration CO<sub>2</sub> as a feed. The basic of the rate expression also varies due to the different limiting conditions assumed. This gives rise to the different variety of kinetic equations with different level of details. Some authors look at the thermodynamics that limit the rate while others consider the mass transfer limitations.

## Control Structure Design for Methanol Process

---

There have been early attempts to model the reaction kinetics for high pressure methanol synthesis with ZnO/Cr<sub>2</sub>O<sub>3</sub> catalyst. Vanden Bussche and Froment, 1996 based their research on equation proposed by Natta. Natta only considered CO hydrogenation and proposed the kinetic equation, (Vanden Bussche and Froment, 1996).

$$r_{CH_3OH} = \frac{f_{CO}f_{H_2}^2 - f_{CH_3OH}/K_2^*}{(A+Bf_{CO}+Cf_{H_2}+Df_{CH_3OH})^3} \quad (2.4)$$

$f_i$  denotes the fugacity of the component  $i$  and A,B,C and D are estimated constants (Vanden Bussche and Froment, 1996).

They first assumed that only CO hydrogenation occurred in the synthesis. It was later discovered that CO<sub>2</sub> must be considered as a feed and that it also contributes to the reaction kinetics. Bakemier et al. included the presence of CO<sub>2</sub> in the kinetic equation with a Langmuir-type isotherm and also studied the catalytic process with ZnO/Cr<sub>2</sub>O<sub>3</sub> catalyst and ended up with the kinetic equation (Vanden Bussche and Froment, 1996).

$$r_{CH_3OH} = Ae^{-E/RT} \frac{\left[ P_{CO}^m P_{H_2}^n \left( 1 - \left( \frac{P_{CH_3OH}}{P_{CO} P_{H_2}^2 K_2^*} \right) \right) \right]}{1 + De^{-F/RT} P_{CO_2}/P_{H_2}} \quad (2.5)$$

Attempts nowadays is based on low-pressure synthesis over Cu-based catalysts, this is due to their ability of improving the process. The first kinetic equation was published by Leonov et al. (Vanden Bussche and Froment, 1996):

$$r_{CH_3OH} = k \left( \frac{P_{CO}^{0.5} P_{H_2}}{P_{CH_3OH}^{0.66}} - \frac{P_{CH_3OH}^{0.34}}{P_{CO}^{0.5} P_{H_2} K_2^*} \right) \quad (2.6)$$

Leonov et al. (1970) also assumed that methanol was produced from CO and neglected CO<sub>2</sub>. Klier et al (1982) considered methanol synthesis solely through CO hydrogenation but also included CO<sub>2</sub> in the kinetic equation. They found that the reaction rate reaches a maximum with certain  $P_{CO}/P_{CO_2}$  ratio. The model proposed by Klier et al (1982) was:

$$r_1 = k_1 \left( 1 + \frac{1}{K_{redox}^{eq}} \frac{P_{CO}}{P_{CO_2}} \right)^{-3} \frac{K_{CO} K_{H_2}^2 \left( P_{CO} P_{H_2}^2 - \frac{P_{CH_3OH}}{K_1^{eq}} \right)}{(1 + K_{CO} P_{CO} + K_{CO_2} P_{CO_2} + K_{H_2} P_{H_2})} \quad (2.7)$$

## Control Structure Design for Methanol Process

$$r_2 = k_2 \left( P_{CO_2} - \frac{1}{K_2^{eq}} \frac{P_{CH_3OH} P_{H_2O}}{P_{H_2}^3} \right) \quad (2.8)$$

The operating conditions for the above expressions are presented in the table below;

**Table 2.4: The experimental conditions used by Klier et al (1982)**

Catalyst	Reactions	Feed [mol%]	T [K]	P [bar]	Type of reactor
CuO – ZnO	$CO + 2H_2 \leftrightarrow CH_3OH$	CO: 0 – 30	498-	75	Tubular
30 – 70	$CO_2 + 3H_2 \leftrightarrow CH_3OH$	CO <sub>2</sub> : 0 – 30	523		integral fixed bed
Metal atomic %	+ H <sub>2</sub> O $CO_2 + H_2 \leftrightarrow CO + H_2O$	H <sub>2</sub> : 70			

Villa et al also noticed that the water gas shift reaction should also be considered. It was also assumed that methanol is only produced through CO hydrogenation. The kinetic models proposed by Villa et al are: (Vanden Bussche and Froment, 1996)

$$r_{CH_3OH} = \frac{f_{CO} f_{H_2}^2 \frac{f_{CH_3OH}}{K_2^*}}{(A + B f_{CO} + C f_{H_2} + G f_{CO_2})^3} \quad (2.9)$$

$$r_{RWGS} = \frac{f_{CO_2} f_{H_2} - f_{CO} f_{H_2O} K_3^*}{M^2} \quad (2.10)$$

Graaf et al (1988) and Graaf et al (1990) derived the kinetic model by looking at both the hydrogenation of CO and CO<sub>2</sub> as well as the water gas shift reaction. Elementary step kinetic equation for each reaction was studied and they ended up with 48 possible reaction schemes. Through statistical discrimination, they selected the kinetic model equation shown below;

$$r'_{CH_3OH,A3} = \frac{k'_{ps,A3} K_{CO} \left( f_{CO} f_{H_2}^{1.5} \frac{f_{CH_3OH}}{f_{H_2}^{0.5} K_{P1}^0} \right)}{(1 + K_{CO} f_{CO} + K_{CO_2} f_{CO_2}) \left( f_{H_2}^{0.5} + \left( \frac{K_{H_2O}}{K_{H_2}^{0.5}} \right) f_{H_2O} \right)} \quad (2.11)$$

## Control Structure Design for Methanol Process

---

$$r'_{CH_3OH,C3} = \frac{k'_{ps,C3} K_{CO_2} \left( f_{CO_2} f_{H_2}^{1.5} - \frac{f_{CH_3OH} f_{H_2O}}{f_{H_2}^{1.5} K_{P_3^0}} \right)}{(1 + K_{CO} f_{CO} + K_{CO_2} f_{CO_2}) \left( f_{H_2}^{0.5} + \left( \frac{K_{H_2O}}{K_{H_2}^{0.5}} \right) f_{H_2O} \right)} \quad (2.12)$$

$$r'_{H_2O,B2} = \frac{k'_{ps,B2} K_{CO_2} \left( f_{CO_2} f_{H_2} - \frac{f_{H_2O} f_{CO}}{K_{P_2^0}} \right)}{(1 + K_{CO} f_{CO} + K_{CO_2} f_{CO_2}) \left( f_{H_2}^{0.5} + \left( \frac{K_{H_2O}}{K_{H_2}^{0.5}} \right) f_{H_2O} \right)} \quad (2.13)$$

The operating conditions used in the study by Graaf et al are presented in table 2.5. The original kinetic equation for two-phase methanol synthesis was derived by Graaf et al in 1988. Later, they found that mass transport limitations has some influence on the kinetics, this raised the need for them to recalculate the values of the parameters.

**Table2.5: The operating conditions used by Graaf et al (1988a)**

Catalyst	Reactions	Feed [mol%]	T [K]	P [bar]	Type of reactor
CuO – ZnO – Al <sub>2</sub> O <sub>3</sub>	CO + 2H <sub>2</sub> ↔ CH <sub>3</sub> OH	CO: 0 – 22	483-	15 – 50	Gradientless spinning basket
	CO <sub>2</sub> + 3H <sub>2</sub> ↔ CH <sub>3</sub> OH	CO <sub>2</sub> : 2,1–26, 1	518		
Haldor Topsøe	+ H <sub>2</sub> O	H <sub>2</sub> : 67,4-90			
Mk 101	CO <sub>2</sub> + H <sub>2</sub> ↔ CO + H <sub>2</sub> O				

They discovered that the kinetic model for two-phase also holds for three-phase synthesis. Graaf et al identified the parameters for the three-phase system and it was noticed that in the three-phase synthesis CO<sub>2</sub> hydrogenation dominates while CO hydrogenation dominates in two-phase synthesis.

(Vanden Bussche and Froment, 1996) states that the equation proposed by Graaf et al has some disagreement concerning the intermediate species of the overall reaction. Assumption by (Vanden Bussche and Froment, 1996) is that CO<sub>2</sub> is the main source of carbon in methanol synthesis. They derived the kinetic equation base on the reaction mechanism given by;

## Control Structure Design for Methanol Process

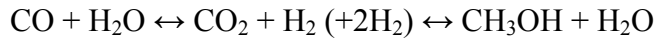

They made the observation but neglected the intermediate species from the kinetic equation.

They proposed the equation below;

$$r_{\text{CH}_3\text{OH}} = \frac{kP_{\text{CO}_2}P_{\text{H}_2}(1 - P_{\text{CH}_3\text{OH}}P_{\text{H}_2\text{O}}/K_1^{eq}P_{\text{CO}_2}P_{\text{H}_2}^3)}{\left(1 + \frac{K_{\text{WH}}P_{\text{H}_2\text{O}}}{P_{\text{H}_2}} + \sqrt{K_{\text{H}_2}P_{\text{H}_2} + K_{\text{H}_2\text{O}}P_{\text{H}_2\text{O}}}\right)^3} \quad (2.14)$$

$$r_{\text{RWGSR}} = \frac{k_2P_{\text{CO}_2}(1 - K_3^{eq}(P_{\text{CO}}P_{\text{H}_2\text{O}}/P_{\text{CO}_2}P_{\text{H}_2}))}{\left(1 + \frac{K_{\text{WH}}P_{\text{H}_2\text{O}}}{P_{\text{H}_2}} + \sqrt{K_{\text{H}_2}P_{\text{H}_2} + K_{\text{H}_2\text{O}}P_{\text{H}_2\text{O}}}\right)^3} \quad (2.15)$$

The operating conditions that led to the proposed kinetics from Vanden Bussche and Froment (1996) are presented in the table below;

**Table2.6: The operating conditions used by Vanden Bussche and Froment (1996)**

Catalyst	Reactions	Feed (mol %)	T (K)	P (bar)	Type of reactor
Cu/ZnO/ Al <sub>2</sub> O <sub>3</sub>	(1) CO <sub>2</sub> + 3H <sub>2</sub> ↔ CH <sub>3</sub> OH + H <sub>2</sub> O (2) CO <sub>2</sub> + H <sub>2</sub> ↔ CO + H <sub>2</sub> O	CO: 0 – 30 CO <sub>2</sub> : 0-30 H <sub>2</sub> : 70 pCO <sub>2</sub> /pCO: 0-4,1	453 - 553	15-51	tubular

The equilibrium constants in the equations  $K_1^{eq}$  and  $K_3^{eq}$  can be determined thermodynamically but in their case they used the values from Graaf et al. (1986).

Another group of scientists Ledakowicz et al. (1992) also studied the synthesis of methanol in bubble column slurry reactor. The two catalysts used in their experiments were suspended in two different inert liquids; paraffin oil (BMT-15) and molten wax (Vestowax SH 105). They discovered this kinetic model in their studies;

$$r_{\text{CH}_3\text{OH}} = k \left[ (C_{\text{H}_2}^2 C_{\text{CO}}) - \left( \frac{C_{\text{CH}_3\text{OH}}}{K_c} \right) \right] \quad (2.16)$$

The operating conditions are presented in the table below;

**Table2.7: The operating conditions used by Ledakowicz et al (1992)**

Catalyst	Reactions	Feed (mol %)	T (K)	P (bar)	Type of reactor
BASF S3- 85 and BT-d <63μm	(1) CO + 2H <sub>2</sub> ↔ CH <sub>3</sub> OH	CO: 17 – 50 CO <sub>2</sub> : 1-5 H <sub>2</sub> : 30 - 65	490 - 533	20-60	Stirred autoclave and bubble column slurry reactor

## Control Structure Design for Methanol Process

Skrzypek et al. (1991) presented Langmuir-Hinshelwood-type kinetic equation for lower-pressure methanol synthesis. The commercial catalysts used were polish CuO (60% wt)-ZnO (30%)-Al<sub>2</sub>O<sub>3</sub> (7.5%) in their study. They discovered that the synthesis reaction favours CO<sub>2</sub> in spite of the fact that CO is considered as the carbon source. They therefore based their kinetic model on reactions (2) and (3). They performed a couple of simple experiments by using a feed consisting of only CO<sub>2</sub> and H<sub>2</sub> methanol formed with no difficulties. Another observation was made by using feed flow made up of CO and H<sub>2</sub> without CO<sub>2</sub> and H<sub>2</sub>O (steam was completely removed from the feed), methanol was not formed. Methanol was formed as soon as water was introduced in the feed. This was due to the water gas shift reaction, where CO and H<sub>2</sub>O produce CO<sub>2</sub>, which further reacts with H<sub>2</sub> to form methanol. They therefore proposed the kinetic model below;

$$r_1 = k_1 K_{H_2}^2 K_{CO_2} \left[ \frac{P_{H_2}^2 P_{CO_2} \frac{P_{CH_3OH} P_{H_2O}}{K_1^{eq} P_{H_2}}}{(1 + K_{H_2} P_{H_2} + K_{CO_2} P_{CO_2} + K_{CH_3OH} P_{CH_3OH} + K_{H_2O} P_{H_2O} + K_{CO} P_{CO})^3} \right] \quad (2.17)$$

$$r_2 = k_2 K_{H_2} K_{CO_2} \left[ \frac{P_{H_2} P_{CO_2} \frac{P_{CO} P_{H_2O}}{K_1^{eq} P_{H_2O}}}{(1 + K_{H_2} P_{H_2} + K_{CO_2} P_{CO_2} + K_{CH_3OH} P_{CH_3OH} + K_{H_2O} P_{H_2O} + K_{CO} P_{CO})^2} \right] \quad (2.18)$$

The experimental conditions used by Skrzypek et al. (1991) are presented in the table below;

**Table 2.8: The operating conditions used by Skrzypek et al. (1991)**

Catalyst	Reactions	Feed (mol %)	T (K)	P (bar)	Type of reactor
CuO-ZnO-Al <sub>2</sub> O <sub>3</sub> commercial Blasiak's catalyst CuO: 62, ZnO: 30 and Al <sub>2</sub> O <sub>3</sub> : 7wt%	(1) CO <sub>2</sub> + 3H <sub>2</sub> ↔ CH <sub>3</sub> OH + H <sub>2</sub> O (2) CO <sub>2</sub> + H <sub>2</sub> ↔ CO + H <sub>2</sub> O	CO: 0 – 20 CO <sub>2</sub> : 5-35 H <sub>2</sub> : 10 - 80	460 - 550	30-90	Integral fixed bed (and also differential)

The kinetic model proposed by Graaf et. al have different concentrations for the intermediate species. Some intermediate species features in two different overall reactions and all these are not accounted for in their model. Skrzypek et al based their measurement on deactivated catalyst and this makes their reaction very slow. The model from Ledakowicz only proposed the model from the first reaction, implying that the other two reactions are only transition



# Control Structure Design for Methanol Process

reactions in the methanol synthesis. The model from Vanden Bussche and Froment will be used since it states that  $\text{CO}_2$  is the source of carbon for the methanol production which has been proven to be true by many of the few methanol producing industries; for example Statoil. Also because of uncertainties about the intermediate species, they neglected them.

## 2.7 Procedure for control structure design for chemical plants

### *Step 1: Definition of operational objectives and constraints*

The operational objectives regarding a particular plant is combined into a scalar cost function  $J$  to be minimized. Other related objectives like safety constraints are normally formulated as constraints.

### *Step 2: Selection of manipulated variables and degree of freedom analysis*

It is very important to choose the number of dynamic or steady-state degrees of freedom because this will help in determining the number of steady-state control variables. This can be found by counting the degrees of freedom for individual units in a complex plant as shown in table 2.10 [24].

**Table 2.9: Typical number of steady-state degrees of freedom for some process units**

Process unit	DOF
External feed stream	1 (federate)
Splitter	$n-1$ split fractions ( $n$ is the number of exit streams)
Mixer	0
Compressor, turbine, and pump	1 (work)
Adiabatic flash tank	0
Liquid phase reactor	1 (holdup)
Gas phase reactor	0
Heat exchanger	1 (duty or net area)
Columns (e.g. distillation) excluding heat exchangers	0 + number of side streams

NB: Add 1 degree of freedom for each extra pressure that is set (need an extra valve, compressor or pump), e.g. in flash tank, gas phase reactor or column.

# Control Structure Design for Methanol Process

## Step 3: Procedure for selecting control variables by using self-optimizing control

### Self-optimizing control

This section outlines the procedure through which we will be able to select the primary controlled variables for the process. As it has already been mentioned the sole purpose of this thesis is to achieve self-optimizing control which means keeping the primary controlled variables  $c$  at constant setpoint  $c_s$  will still lead to near-optimal operation indirectly.

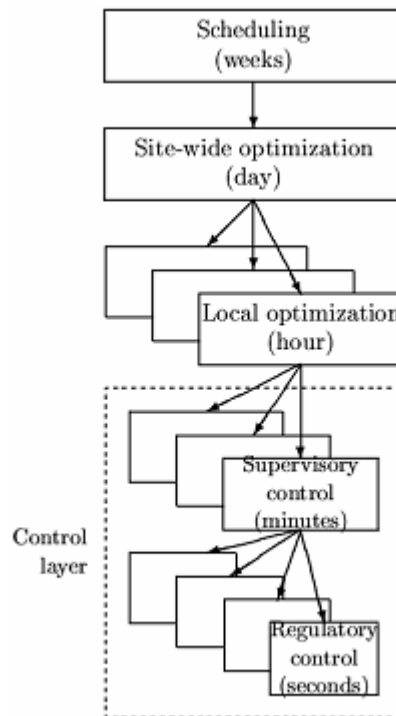

Figure 2.6: Typical control layer for a chemical plant

*Self-optimizing control* is when acceptable operation (acceptable loss in the objective function) can be achieved by using pre-calculated setpoints,  $c_s$ , for the controlled variables ( $y$ ) (without the use of re-optimization when disturbances occur) [18]. One way in solving such a problem is to evaluate the effect of disturbances and implementation error on the objective function. The main steps for this procedure are as follows [18];

1. Degree of freedom analysis
2. Definition of optimal operation

## Control Structure Design for Methanol Process

---

3. Identification of important disturbances
4. Optimization
5. Identification of candidate control variables  $c$ .
6. Evaluation of loss for alternative combinations of controlled variables (loss imposed by keeping constant set points when there are disturbances or implementation errors), including feasibility investigation.
7. Final evaluation and selection (including controllability analysis).

The control variables  $c$  selected should be able to satisfy the following requirements;

- a) its optimal value should be insensitive to disturbances
- b) easy to measure and control (in order to make the implementation error acceptable)
- c) sensitive to changes in the manipulated variable (steady-state degrees of freedom)
- d) it should be independent, for cases with more than one unconstrained degrees of freedom

### *Local (linear) method*

Brute force method (Direct loss evaluation) [18] is a simple way of finding the candidate control variables ( $y$ ) and the possible disturbances ( $d$ ) when they are small in numbers.

The loss function ( $L$ ) can be defined as the difference in the objective function for  $J_{opt}(d)$  and  $J(u,d)$ .

$$L = J(u, d) - J_{opt}(u, d) = \frac{1}{2} \|Z\|_2^2 \quad (2.21)$$

The  $z$  in the formulae is defined as  $z = J_{uu}^{-\frac{1}{2}}(u - u_{opt}) \equiv J_{uu}^{1/2} G^{-1}(c - c_{opt})$ , where  $G$  is the steady-state gain matrix from the unconstrained degrees of freedom  $u$  to the controlled variables  $c$  and  $J_{uu}$  is the Hessian of the objective function with respect to the  $u$ . Ideally for optimal cases  $L = 0$ , but in reality  $L > 0$ . The value of  $L$  should be reasonably small implying that the plant will be operating close to its optimum. The most important thing here is to find variables to keep constant and not the optimal sets of variables.

From [25], assuming that each controlled variable  $c_i$  is scaled such that;

$\|e'_c\| = \|c' - c'_{opt}\| \leq 1$ , the worst case loss given by;

## Control Structure Design for Methanol Process

---

$$L_{max} = \max_{\|e_c\|_2 \leq 1} L = \frac{1}{2} \frac{1}{\underline{\sigma}(S_1 G J_{uu}^{-1/2})^2} \quad (2.22)$$

Where  $S_1$  is the matrix of scaling for  $c_i$ :

$$S_1 = \text{diag} \left\{ \frac{1}{\text{span}(c_i)} \right\} \quad (2.23)$$

Where  $\text{span}(c_i) = \Delta c_{i,opt}(d) + n_i(\Delta c_{i,opt}(d))$  is the variation of  $c_i$  due to variation in disturbances ( $d$ ) and implementation error ( $n_i$ ).

In order to minimize the loss  $L$ ,  $\underline{\sigma}(S_1 G J_{uu}^{-1/2})$  should be maximized or  $\underline{\sigma}(S_1 G)$  should be maximized.

### *Step 4: Production rate and Inventory control*

At steady-state, it is at least required that the flow through all units (in terms of mass) to be constant, and this can be achieved by keeping the total inventory (mass holdup) in each unit constant [27]. The total inventory (holdup, level) has very little or no effect at steady-state but it is controlled anyway for mass balance satisfaction and stable operation. The liquid holdup/level can be controlled using inflow or outflow. Where the production rate is set gives a little insight about the direction of the flow that can be used for the inventory control.

### *Step 5: Regulatory control*

This layer is made up of single-input-single-output (SISO) PI control loops. Its objective is for stabilization. The controlled variables for this layer are the measured output variables and their setpoints can be used as degrees of freedom for the layers above. The use of manipulated variables that saturates during operation should be avoided in this layer because they can cause in lost in control and demands a new configuration for the loops. A good secondary control variable should have the following properties [27];

- a) easy to measure
- b) easy to control using one of the manipulated variables (the manipulated variable should have a direct, fast and strong effect on it).
- c) For stabilization: the measurement should be able to detect unstable mode quickly

## Control Structure Design for Methanol Process

---

- d) For local disturbance rejection: the variable is located closer to an important disturbance downstream.

To assign control loops at this layer, we first need to know where to set the production rate and then make an assumption that the level loops are stabilized. For an unstable process a pole vector analysis can be used to determine the secondary control variable. This method is beyond the scope of this project.

### *Step 6: Supervisory control*

The purpose of this layer is to keep the primary controlled outputs  $c$  at their optimal setpoints  $c_s$  by making use of the setpoints of the regulatory layer and any unused manipulated variable as degree of freedom. The variables to be controlled and their corresponding setpoints are determined by optimization. Either decentralized or multivariable control can be used for this layer. Decentralized control is preferred for non-interacting processes and cases where active constraints remain constant [27].

### *Step 7: Optimization*

The overall control objective is to maintain acceptable operation (in terms of environmental impact, load on operators, and so on) while keeping the operating conditions close to economically optimal [18]. Increasing the economics of a process is the sole goal of optimization in process industries. The economic objective is transformed into technical objectives such as increasing the production rate and quality of the product in consideration, also decreasing the consumption of energy as well as maintaining safe operation.

More often than not there are constraints related to the quality and safe operation of the product and plant respectively. The optimization problem is a mathematical representation of the technical objectives for measuring the performance of the process. The objective function is denoted by  $J$  in this project and it is defined as;

$$\min J_o(x, u_o, d) \quad (2.19)$$

Subjected to the constraints

$$g_1(x, u_o, d) = 0; g_2(x, u_o, d) \leq 0 \quad (2.20)$$

## Control Structure Design for Methanol Process

---

where  $u$  are the independent variables we can affect (degrees of freedom for optimization),  $x$  represents internal variables (states) and  $d$  are independent variables we cannot affect (disturbances).

The objective function  $J$  can either be maximized or minimized depending on the given problem subjected to constraints by using available inputs and parameters  $u$  (decision variables). There a whole lot methods used in solving the optimization problem, such methods are beyond the scope of this project.

### *Step 8: Validation*

A better way of validating the determined plantwide control structure is to use a nonlinear dynamic simulation to test it.

## Chapter 3

### Methanol Process Description

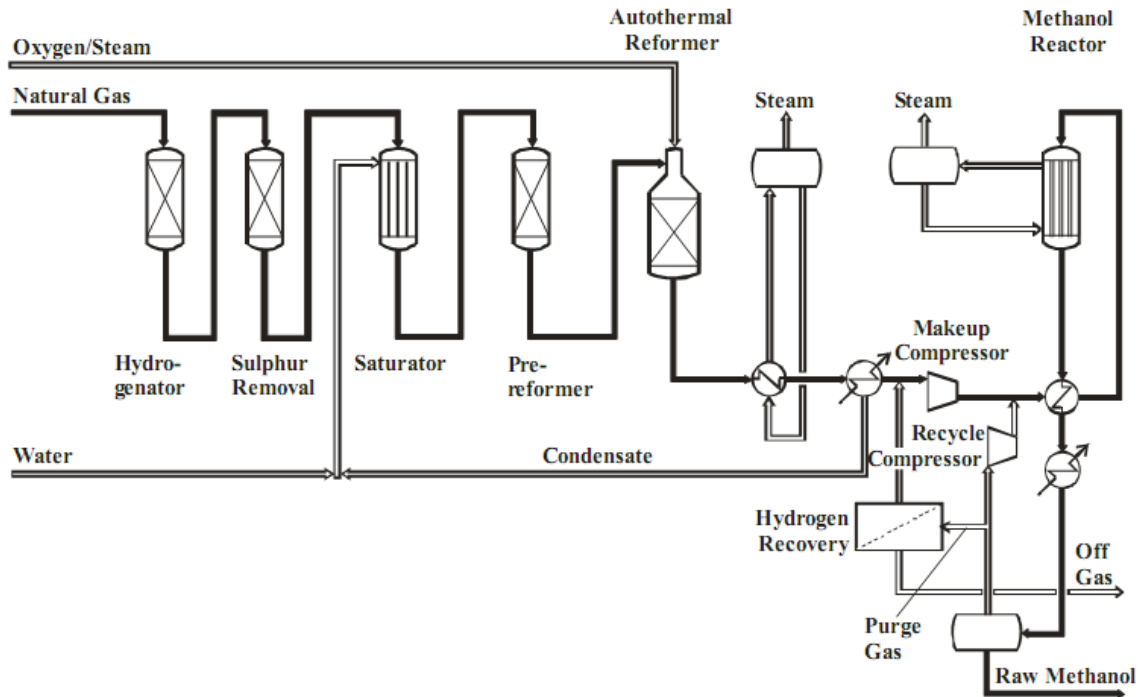

Figure 3.1: Process flowsheet for methanol production

The detailed description of methanol synthesis is described in this chapter. The synthesis gas used for the production of methanol can be made from natural gas. Natural gas at [50°C, 70bar] is first of all expanded to reduce the pressure to [30bar]. Water is also needed for the reforming of the natural gas. Water at [30°C, 1bar] is pumped to increase the pressure to 30bar. The resulting solutions are then preheated to reach vapour phase prior to entering the pre-reformer.

#### 3.1 Pre-reforming

Pre-reforming is the term that has been applied to the low temperature steam-reforming of hydrocarbons in a simple adiabatic reactor. The pre-reformer utilizes the heat content of the feed stream to drive the steam reforming reaction at low temperatures. This reactor also uses nickel catalyst to promote the rate of the reaction. This pre-reformer is able to convert the

## Control Structure Design for Methanol Process

higher hydrocarbons into methane and carbon dioxide. It operates at a temperature of about 497°C, [12]. The pre-reforming reactions result in an equilibrium gas mixture containing hydrogen, carbon monoxide, carbon dioxide, methane and steam as per the reactions given below:

**Table3.1: Pre-reforming reactions**

Reaction	$\Delta H$ (kJ/mol)	$\Delta G$ (kJ/mol)	$\Delta S$ (J/Kmol)	$T_{\text{carnot}}$ (K)
$C_2H_6 + 2H_2O \rightarrow 2CO + 5H_2$	347.24	215.70	441.41	786.66
$C_3H_8 + 3H_2O \rightarrow 3CO + 7H_2$	521.46	282.52	801.81	650.35
$n-C_4H_{10} + 4H_2O \rightarrow 4CO + 9H_2$	676.77	365.62	1044.14	648.16
$CH_4 + H_2O \leftrightarrow CO + 3H_2$	205.88	141.97	214.47	959.95
$CO + H_2O \leftrightarrow H_2 + CO_2$	-41.14	-28.61	-42.05	978.36

In the pre-reformer, the endothermic reaction is followed by the exothermic methanation and shift reactions, adjusting the chemical equilibrium between the carbon oxides, methane, hydrogen and water according to above reactions.

### 3.2 Autothermic reaction

ATR operates at low steam to carbon ratios [1] and the development of new burner designs ensures safe operation and high on-stream factors. The alternative measurement to achieve lower  $H_2/CO$  ratios is the addition of oxygen. Autothermic reforming is the reforming of light hydrocarbons in a mixture of steam and oxygen in the presence of a catalyst, [11]. The oxidation reaction is used to adjust a synthetic ratio [7]. In this project, the autothermal reforming processes was used to produce synthesis gas with a synthetic ratio of approximately 2. The reactions occurring in the ATR reactor is shown below:

**Table3.2: Reactions occurring in the ATR reactor**

Reaction	$\Delta H$ (kJ/mol)	$\Delta G$ (kJ/mol)	$\Delta S$ (J/Kmol)	$T_{\text{carnot}}$ (K)
$CH_4 + 1.5O_2 \leftrightarrow CO + 2H_2O$	-519.60	-543.80	81.23	-6396.65
$CH_4 + H_2O \leftrightarrow CO + 3H_2$	205.88	141.97	214.47	959.95
$CO + H_2O \leftrightarrow H_2 + CO_2$	-41.14	-28.61	-42.05	978.36

### 3.3 Separation process

Since all the reactions occurring in the ATR are exothermic reactions, the temperature of the product is very high. The products need to be cooled to a lower temperature before the



## Control Structure Design for Methanol Process

separation can take place. After cooling the products, it is then separated into the synthesis gas part leaving at the top of the separator while the water in the mixture leaves at the bottom.

### 3.4 Compression

The pressure of the synthesis gas emanating from the separator is increased from 30 bar to 80 bar and this is done by using a compressor. The compressed mixture is then mixed with a recycle stream from the flash drum as shown in the flow sheet. The temperature of the resulting mixture is then raised to 270°C before it enters the methanol reactor.

### 3.5 Methanol synthesis

The make-up synthesis gas and the recycle at [270°C, 80 bar] contains mostly hydrogen, carbon monoxide and carbon dioxide. The main reactions for the methanol formation are hydrogenation of CO, hydrogenation of CO<sub>2</sub> and then coupled with the reverse water gas shift reaction. Methanol is thermodynamically less stable [12] and therefore the catalyst used should be very selective. The three reactions are as follows:

	Reaction	$\Delta H$ (kJ/mol)	$\Delta G$ (kJ/mol)	$\Delta S$ (J/Kmol)	$T_{\text{carnot}}$ (K)
1	$\text{CO} + 2\text{H}_2 \leftrightarrow \text{CH}_3\text{OH}$	-90.45	-25.15	-219.13	412.77
2	$\text{CO}_2 + 3\text{H}_2 \leftrightarrow \text{CH}_3\text{OH} + \text{H}_2\text{O}$	-49.43	3.46	-177.09	279.12
3	$\text{CO}_2 + \text{H}_2 \leftrightarrow \text{H}_2\text{O} + \text{CO}$	+41.14	28.61	42.05	978.36

Two independent reactions (hydrogenation of carbon monoxide and the reverse water gas shift) were considered out of the three dependent reactions (1) – (3). The rate of reaction constants combined with the equilibrium rate constants provides enough information about kinetics of methanol synthesis. The reaction rate constants, adsorption equilibrium constants and reaction equilibrium constants which appear in kinetics expressions are tabulated in 3.3.

The reactor effluent is cooled to 40°C before it is sent to the vapour-liquid separator. Gas/liquid separation is carried out in a vessel under pressure. The gas is recycled after purging a small part to keep the level of inerts within the loop within limits. The crude methanol is then sent to the purification section. The design specifications and catalyst information for industrial methanol reactor is given in the table 3.4.

## Control Structure Design for Methanol Process

**Table3.3: Kinetic and equilibrium data**

$k = A \exp(B/R_g T)$	A	B
$k_a$ (bar <sup>-1/2</sup> )	0.499	17197
$k_b$ (bar <sup>-1</sup> )	$6.62 \times 10^{-11}$	124119
$k_c$	3453.38	-
$k_d$ (mol/kg s bar <sup>2</sup> )	1.07	36696
$k_e$ (mol/kg s bar)	$1.22 \times 10^{10}$	-94765
$K^{eq} = 10^{(A/T-B)}$	A	B
$K_1^{eq}$ (bar <sup>-2</sup> )	3066	10.592
$K_2^{eq}$	2073	2.029

**Table3.4: Catalyst and reactor data**

Parameter	Value
Number of tubes	5500
Density (kgm <sup>-3</sup> )	1775
Particle diameter (m)	$5.47 \times 10^{-3}$
Heat capacity (kJ kg <sup>-1</sup> K <sup>-1</sup> )	5
Length of reactor (m)	7.022
Bed void fraction	0.39
Density of catalyst bed (kgm <sup>-3</sup> )	1140
Tube inner diameter (m)	0.038
Tube outer diameter (m)	0.042

### 3.6 Purification

The water-methanol mixture is distilled in order to meet the final specifications. It is essential for methanol to be stabilized (either by distillation or by deep flashing) in order to remove volatile components such as CO<sub>2</sub> and permit shipment and transport in atmospheric vessels. There are three grades of methanol namely: *chemical grade AAA (99.85wt% MeOH, 0.1wt%*

## Control Structure Design for Methanol Process

---

water, and concentrations of higher alcohols at parts-per-million levels), Fuel grade (97wt% MeOH, 1 wt% water, 1.5wt% alcohols and 0.5wt% of process oil) and MTBE grade (97wt% MeOH, 1wt% water, 2wt% alcohols, 150ppm methyl acetate, 0.3wt% inert liquid medium).

### 3.7 Details of the methanol process model in UniSim™

A schematic flowsheet for the methanol production in UniSim™ is shown in figure 3.2 and the corresponding stream conditions are at the appendix.

Methanol production from synthesis gas is simulated using Honeywell UniSim Design R380 with Soave-Redlich-Kwong (SRK) fluid package. Mass and energy balances have been established for all cases. The Soave-Redlich-Kwong equation of state was used to calculate the stream physical and transport properties. The pressure drop across all the unit operations is set to 0.kPa. The simulation overview will be divided into several sections namely feed conditioning, pre-reforming, autothermal reforming (ATR), methanol production and purification. The catalyst used for the simulation was the Cu/ZnO/Al<sub>2</sub>O<sub>3</sub> which has a selectivity of over 99%.

#### *Feed Conditioning*

Table 3.5 shows the composition of the natural gas used in the simulation;

**Table3.5: Natural gas composition**

Component	Mole fraction
Nitrogen	0.006
Methane	0.955
Ethane	0.03
Propane	0.005
n-Butane	0.004

The natural gas is introduced at [50°C, 70bar], it is then expanded by K-101 to [30bar] before it is preheated to (497 °C). Fresh water at [30°C, 1bar] is also pumped to (30bar) and then preheated to (252 °C) by exchanging heat with the effluent from the autothermal reactor as depicted in figure 3.2. The saturated steam produced is split into two where part of it used for

## Control Structure Design for Methanol Process

---

the steam reforming of natural gas and the other for the air separation unit (ASU). The preheated natural gas and water then enters the pre-reformers.

### *Pre-reforming*

It is made up of two reactors; the first one is modelled as a conversion reactor in which the higher hydrocarbons namely ethane, propane and n-butane are converted into hydrogen and carbon monoxide through conversion reactions. It is an adiabatic reactor and all the reactions have 100% conversion. The reactions taking place in this reactor has already been described in the section.

The main components that should be present for the reactions to proceed are the preheated natural gas and steam. The unconverted natural gas (mainly methane) and the products as a result of the three reactions (stream 4 at 291°C) are then fed into the next pre-reformer which is an equilibrium reactor and also modelled as an adiabatic reactor. The reactions that goes on in the equilibrium reactor is the steam reforming of methane and the water gas shift reaction. Both reactions are exothermic. The products (stream 5) from the second pre-reformer are mainly methane, water, hydrogen, carbon monoxide and carbon dioxide. The carbon monoxide content in (stream 5) reduces due to the water gas shift reaction.

### *Autothermal reforming (ATR)*

To operate the autothermal reformer, the unconverted methane, water, hydrogen, CO, CO<sub>2</sub> and nitrogen from the pre-reformer and air are first fed into the reformer for combustion to heat up the catalyst of the reformer. Since the technology involve the use of combined reforming, the steam to carbon ratio was 0.6, this is because lower ratios do not favour soot and coke formation which is not desired in autothermal reforming process. The oxygen to carbon ratio was also found to be 0.5667 after the simulation. In brief, this model takes into account three principal reactions as shown in the process description section and six gas species including methane (CH<sub>4</sub>), oxygen (O<sub>2</sub>), carbon dioxide (CO<sub>2</sub>), water (H<sub>2</sub>O), carbon monoxide (CO) and hydrogen (H<sub>2</sub>) in chemical kinetics. Nitrogen (N<sub>2</sub>) present in the inlet air is considered as a diluent, which affects only the gas property.

# Control Structure Design for Methanol Process

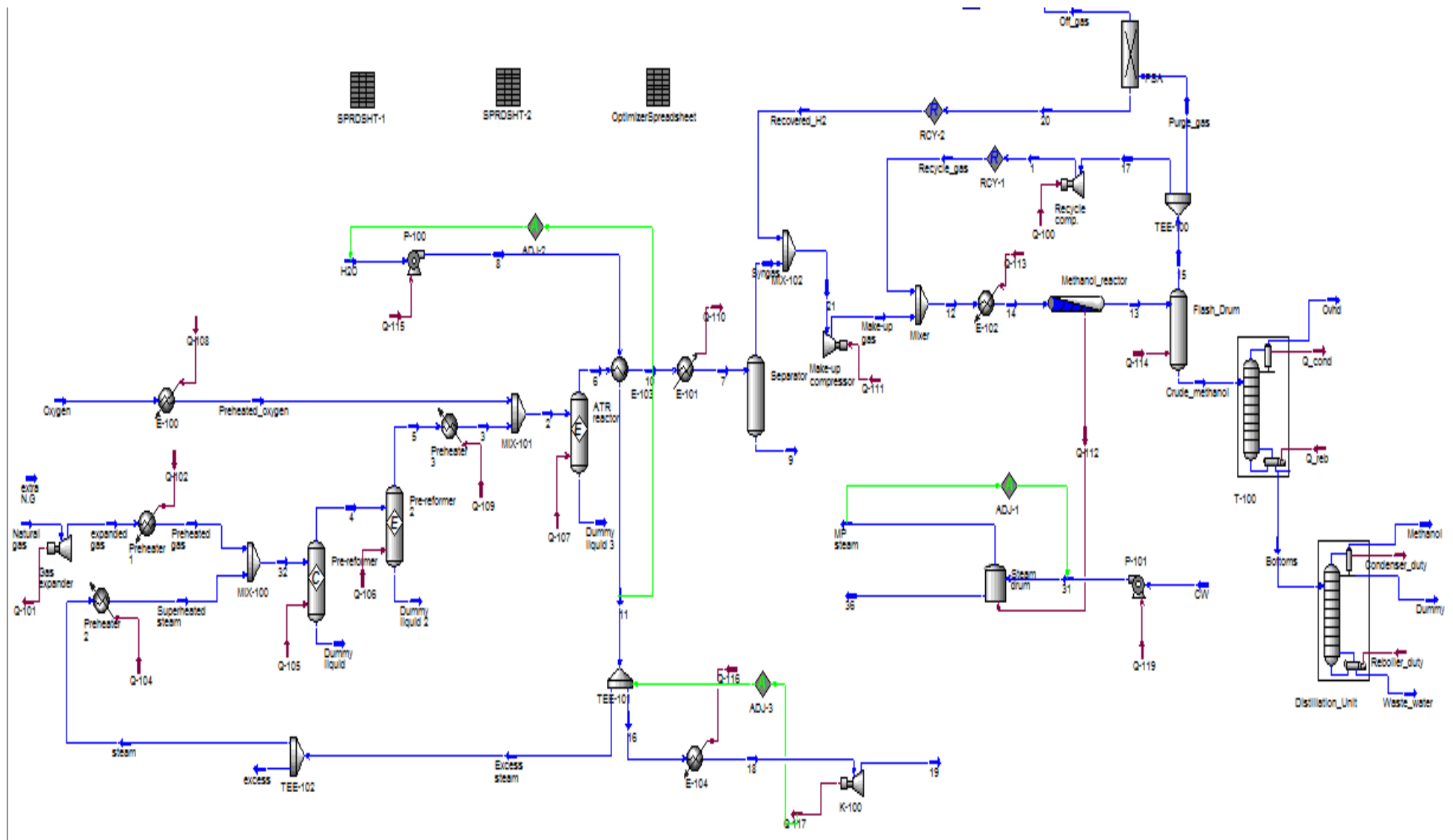

Figure3.2: Methanol UniSim™ process flowsheet

## Control Structure Design for Methanol Process

---

Since the stoichiometry of all the reactions were known, the reformer was modelled as an equilibrium reactor. The outlet stream composition and properties were calculated by UniSim.

The temperature of the effluent gas from the ATR is around 1095°C, a heat exchanger is installed right after the reactor to produce a medium pressure steam which will be used to drive the compressor used in the air separation unit (ASU). The energy required by the ASU is 300 kWh/ton of oxygen. The properties of the steam produced are 252.4 °C and 40bar.

The production of steam reduces the temperature of the gas to 200 °C, but there is still the need for us to cool down the mixture to 20°C before the separation takes place. The separation is mainly done to get rid of the water in the gas mixture. The synthesis gas produced has a module (M) of 1.867. The syngas is deficient in hydrogen and this call for some adjustment in the M before it will be suitable for methanol production.

### *Methanol Synthesis*

The synthesis gas leaving the separator is compressed to 76.98bar, the make-up gas as shown on the diagram is then mixed with the recycled stream which is very rich in hydrogen but this amount of hydrogen is still not enough for the adjustment, therefore a pressure swing absorption (PSA) unit is installed to produce some pure hydrogen, and this adjusts the M to 2.03. The recycle ratio for the process is 4.71. The resulting mixture is heated again to a suitable temperature (270 °C) for the reaction to proceed. The methanol reactor is simulated as plugged flow reactor (PFR) made up 5500 tubes. As described by the kinetics there are only two independent reactions taking place in the reactor. The details of the reaction and how it is applied in UniSim is shown at the appendix.

The effluent from the methanol reactor is flashed to get rid of some of the unwanted gases in the final product. This is done at a temperature of 40°C by the flash as shown on the flowsheet. The resulting crude methanol produced is then sent to the distillation column for purification. About 96.5% of the unreacted synthesis gas is recycled to the methanol reactor and the other part is purged from the process to reduce the amount of inerts in the loop. A different kind of technology was used in the process known as the pressure swing adsorption unit; this equipment was used to produce pure hydrogen from the purge gas. The hydrogen produced was about 17% of the hydrogen found in the purge gas. Some of the combustible

## Control Structure Design for Methanol Process

---

gases found in the off-gas were burned to supply energy to the fired heater at the synthesis gas production section. The combustibles include hydrogen, carbon monoxide and methane. This brought the total of gases released into the environment to be around 300 tonnes/day.

Only two distillation columns are installed in this simulation, it is usually three in practice. This is because we did not consider the formation of higher alcohols in our model like ethanol and glycol. The first distillation column removes most of the carbon dioxide in the crude methanol produced. The amount removed in this process was precisely 91wt%. It consists of only 10 trays and the feed was assumed to enter at the middle of the column which is tray number 5. The condenser and reboiler pressures were 1050kPa and 1100kPa respectively. The products leaving the column then enter the second distillation column. The second distillation unit removes the valuable product which is methanol from the top while the bottoms consist mainly of water and small traces of other gases. The column consists of 24 trays and the pressure difference is about 15kPa. The methanol is emanating at a temperature of 138.6°C and that of water is at 178.6°C. The methanol produced is about 99.96 wt% of the top products.

The table below shows the properties of the gases produced after the simulation

	Synthesis gas	Methanol	Off-gas
<i>Mass flow [tonne/day]</i>	6155	4671	1065
<i>Temperature [°C]</i>	20	138.6	41.61
<i>Pressure [bar]</i>	30	10	71.98
<b><i>Mole fraction</i></b>			
<i>H<sub>2</sub></i>	0.6569	-	0.6069
<i>CO</i>	0.2932	-	0.2505
<i>CO<sub>2</sub></i>	0.0382	-	0.0708
<i>H<sub>2</sub>O</i>	0.0009	0.0004	0.0002
<i>CH<sub>4</sub></i>	0.0089	-	0.0531
<i>N<sub>2</sub></i>	0.0020	-	0.0123
<i>CH<sub>3</sub>OH</i>	-	0.996	0.0061

## Chapter 4

### Results and Discussion

This section describes the results obtained from the simulation of the process in UniSim™, starting with the synthesis gas part, the methanol synthesis part and self-optimizing control procedure applied on the process.

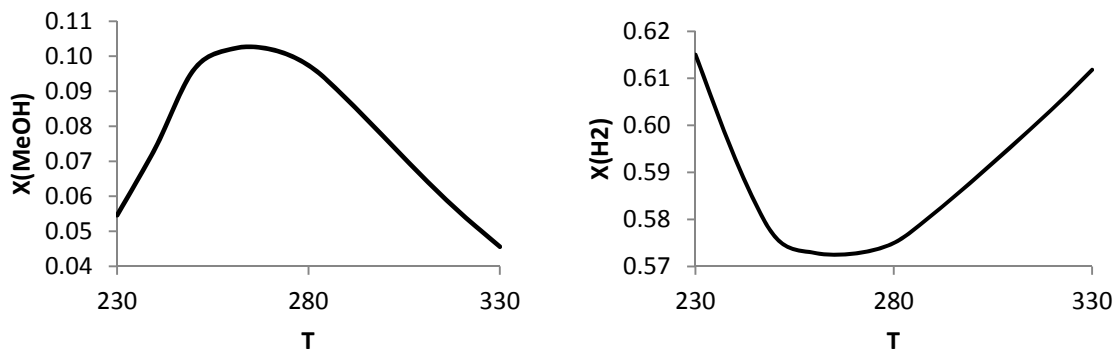
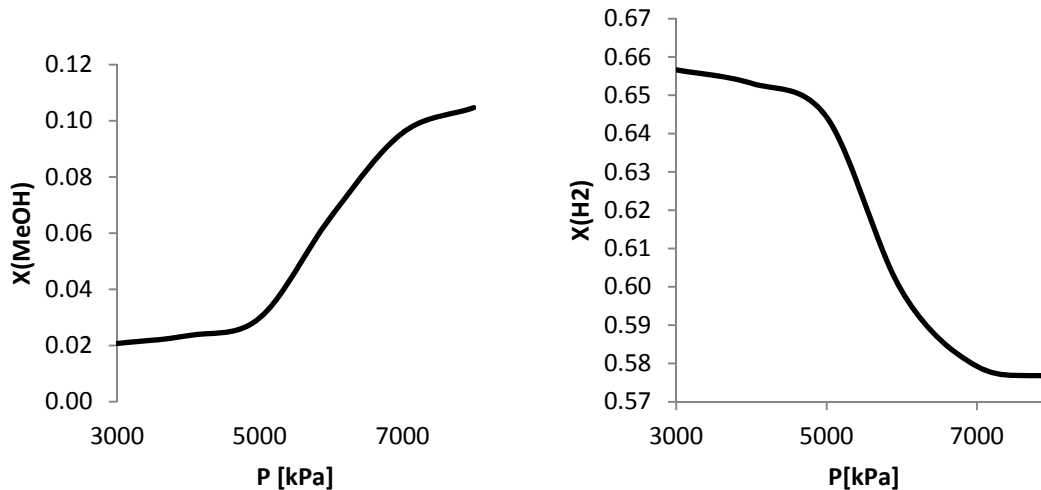

**Figure 4.1: Steady-state concentrations with varying temperature ( $P = 76.98\text{bar}$ ).**

The diagrams show how the concentration of methanol and hydrogen changes with the temperature of the process. Although the diagram shows the optimum temperature to be around  $270^\circ\text{C}$ , this temperature can affect the activity of the catalyst in the reactor and also will lead to deactivation of the catalyst within a short period of time. Instead a temperature of  $250^\circ\text{C}$  was used in the simulation.



# Control Structure Design for Methanol Process



**Figure 4.2: Steady-state concentration with varying pressure ( $T = 270^{\circ}\text{C}$ )**

The figure shows that the concentration of methanol increases with an increase in pressure and in the same shows that more hydrogen is consumed for the production of methanol. This is because of the increase in reactant partial pressures. Both reactions that  $\text{CO}_2$  hydrogenation and  $\text{CO}$  hydrogenation are nonequimolar with fewer molecules of products than reactants. The principle proposed by Le Chatelier helps us to understand that high pressure drives the reaction to the right.

The optimal recycle ratio found was 0.965, which means 96.5% of the unconverted syngas is recycle back to the reactor. The resulting inert compositions in the purge gas are 5.45 mol % of methane and 1.22 mol% of nitrogen. The remaining components represent the losses of reactant hydrogen, carbon monoxide and carbon dioxide. Increasing the split ratio (recycled gas) will increase the composition of inert components in the off gas but in effect reduce the amount of reactants in the off gas, which only has fuel value. However when the amount of inert in the recycle is low it affects the kinetics and also require higher recycle flow rates, and this will increase the recycle compressor costs. This means there is always a trade-off between off gas losses and recycle compressor energy and capital costs.

## 4.1 Self-optimizing control

The procedure outlined for self-optimizing control of a process according to [17].

### 4.1.1 Step 1: Degree of freedom analysis

The methanol plant with a fixed molar flowrate of natural gas has 7 degrees of freedom as shown in table 4.1.

# Control Structure Design for Methanol Process

---

**Table4.1: List of manipulated variables**

	Manipulated variable
U1	Oxygen flowrate [kgmole/hr]
U2	Water flowrate [kgmole/hr]
U3	Outlet temperature of fired heater [°C]
U4	Pressure at syngas section [bar]
U5	Pressure at methanol synthesis section [bar]
U6	Recycle % to methanol reactor
U7	Recycle % of pure hydrogen to make-up gas

## 4.1.2 Step 2: Definition of optimal operation

The objective function considered for optimization of this process was based on the carbon efficiency for the whole plant which is an important operating parameter for overall energy efficiency. The carbon efficiency is defined as the ratio of moles of methanol in the outlet stream to the moles of inlet carbon including the moles of carbon in fresh natural gas for the fired heater. The following objective function is to be maximized:

$$J = \frac{\text{molar flow of methanol } \left[\frac{\text{kgmole}}{\text{hr}}\right]}{\text{molar flow of carbon contents in natural gas for the plant } \left[\frac{\text{kgmole}}{\text{hr}}\right]}$$

subject to the constraints:

1. The temperature of the methanol reactor

$$T_{r,\max} \leq 270^\circ\text{C}$$

2. Outlet temperature of fired heater

$$1000^\circ\text{C} \leq T_{\text{ATR}} \leq 1100^\circ\text{C}$$

3. Temperature of the coolant

$$240^\circ\text{C} \leq T_c \leq 260^\circ\text{C}$$

4. Recycle ratio

$$0 \leq R \leq 1$$

5. Maximum production rate

$$F_{\text{methanol}} \leq 5000\text{tonne/day}$$

## 4.1.3 Step 3: Optimization

Optimization was performed using the 7 degrees of freedom by making use of the SQP algorithm in UniSim™.to the find the optimal nominal operating point.

## Control Structure Design for Methanol Process

Variable	
Optimal objective function [%]	87.21
U1	4024
U2	4266
U3	650
U4	30
U5	76.98
U6	96.5
U7	17

### 4.1.4 Step 4: Identification of important disturbances

The following disturbances (errors) were considered for this process:

**Table4.2: Disturbances to the process**

		Nominal	Disturbance
D1	Natural gas flow rate	7300	-20%
D2	Natural gas flow rate	7300	+20%
D3	Natural gas composition	0.955	-10%
D4	Natural gas composition	0.955	-5%
D5	Inlet temperature of ATR	650°C	-25
D6	Inlet temperature of ATR	650°C	+25

The process was reoptimized when different disturbances occur, and it was discovered that the exit temperature was always active. This implies that 6 control variables should be identified for the 6 unconstrained degrees of freedom. We continue the experiment and try to find out whether some the unconstrained degrees of freedom can be kept constant at the optimal nominal values and achieve near-optimal operation and at the same time get a minimum acceptable loss in the presence of disturbances and implementation error. The ideal case is to achieve an acceptable loss in the presence of disturbances without reoptimizing the degrees of freedom when disturbances and implementation errors occur.

This leads us to the concept of self-optimizing control approach, a series of simulation experiments were performed by reoptimizing the process when different disturbances occur. a minimal loss in the objective function. A series of graphs were obtained and these are presented below;

# Control Structure Design for Methanol Process

First disturbance: change in flow rate of natural gas ( $\pm 20\%$ )

(a) Changes in natural gas flowrate ( $\pm 20\%$ )

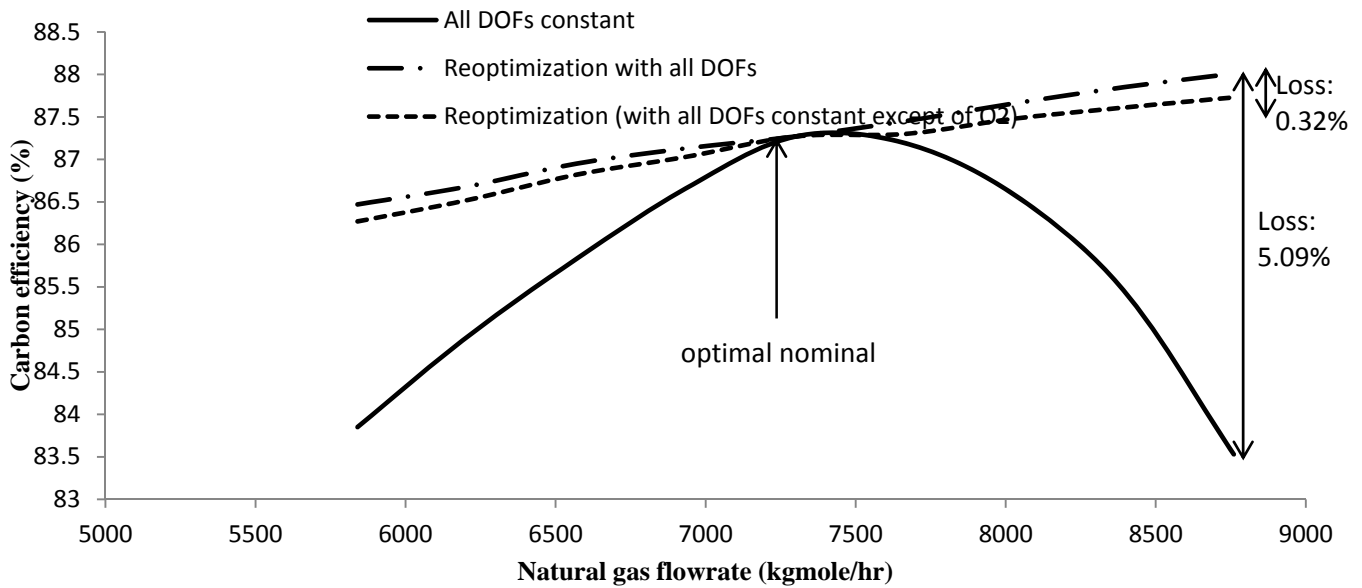

(b)

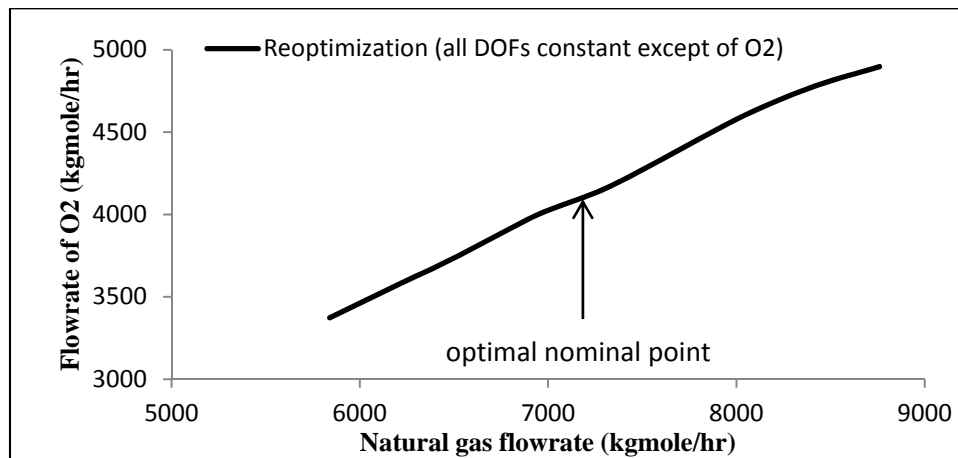

Figure4.3: Change in natural gas flow rate

The flowrate of the natural was allowed to fluctuate between  $\pm 20\%$ . The solid line in figure 4.3a shows the value of the objective function when changes are made to the natural gas flowrate while the degrees of freedom remain fixed at their optimal nominal points. The traditional policy, which is to keep the degrees of freedom constant, gave a loss of 5.09% in the carbon efficiency when the natural gas flowrate recorded an increase of 10%. The dotted line shows the reoptimization of the objective function when flowrate of natural gas changes and the degrees of freedom are allowed to vary. It was discovered that the optimal variation

## Control Structure Design for Methanol Process

in the flowrate of oxygen was found to be the greatest amongst the remaining six degrees of freedom and this is shown in figure 4.3b. These gave us a clue that we can keep the other degrees of freedom constant and allow the flowrate of oxygen to fluctuate during reoptimization. The dashed line depicts the observation we made and the loss was recorded an acceptable loss of 0.32% in the objective function at the worst case. Since there are other disturbances to consider it cannot be concluded here that keeping the five unconstrained degrees of freedom constant is the best solution.

### *Second disturbance: Change in natural gas composition*

(a)

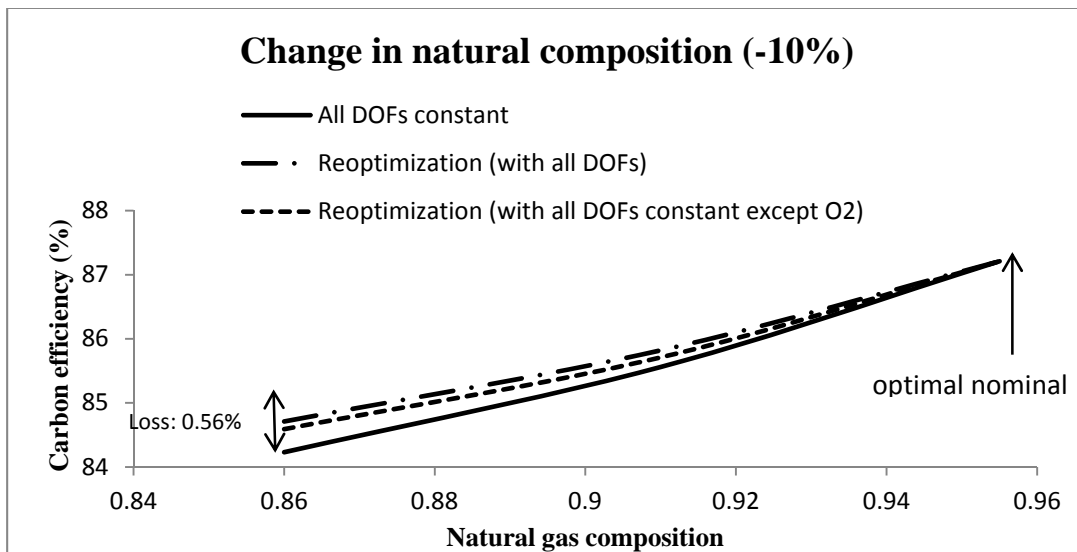

(b)

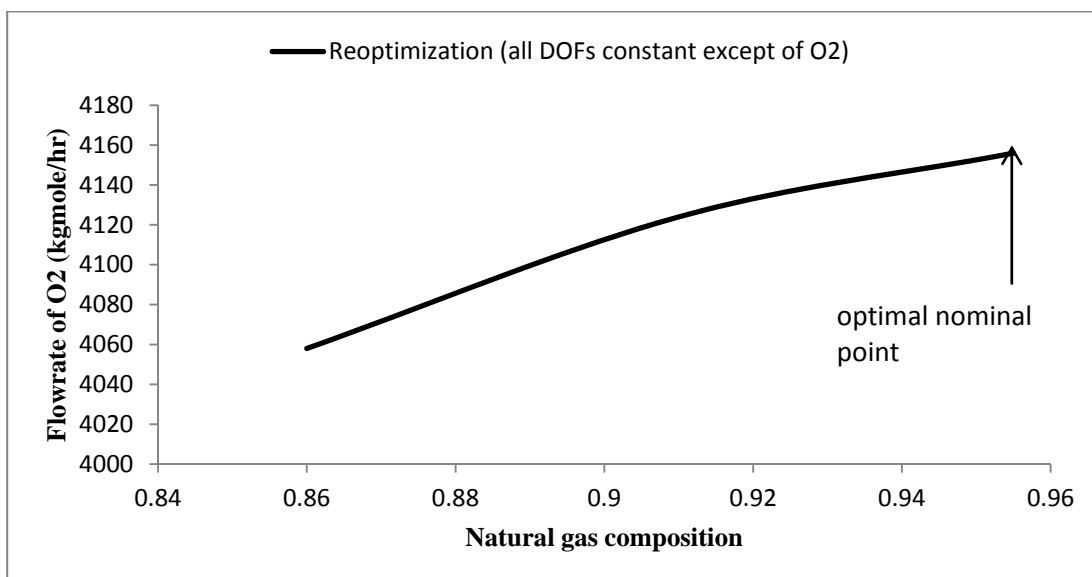

Figure4.4: change in natural gas composition

## Control Structure Design for Methanol Process

Following the same procedure as the first one, a second disturbance was considered which was a change in the composition of natural gas. The composition of methane changed from 95.5% to 85%. The effect of this disturbance was less significant. The worst case gave a loss of 0.56% while when the flowrate of oxygen was included for reoptimization the loss was approximately zero.

**Third disturbance: Change in outlet temperature of fired heater ( $\pm 25^\circ\text{C}$ )**

(a)

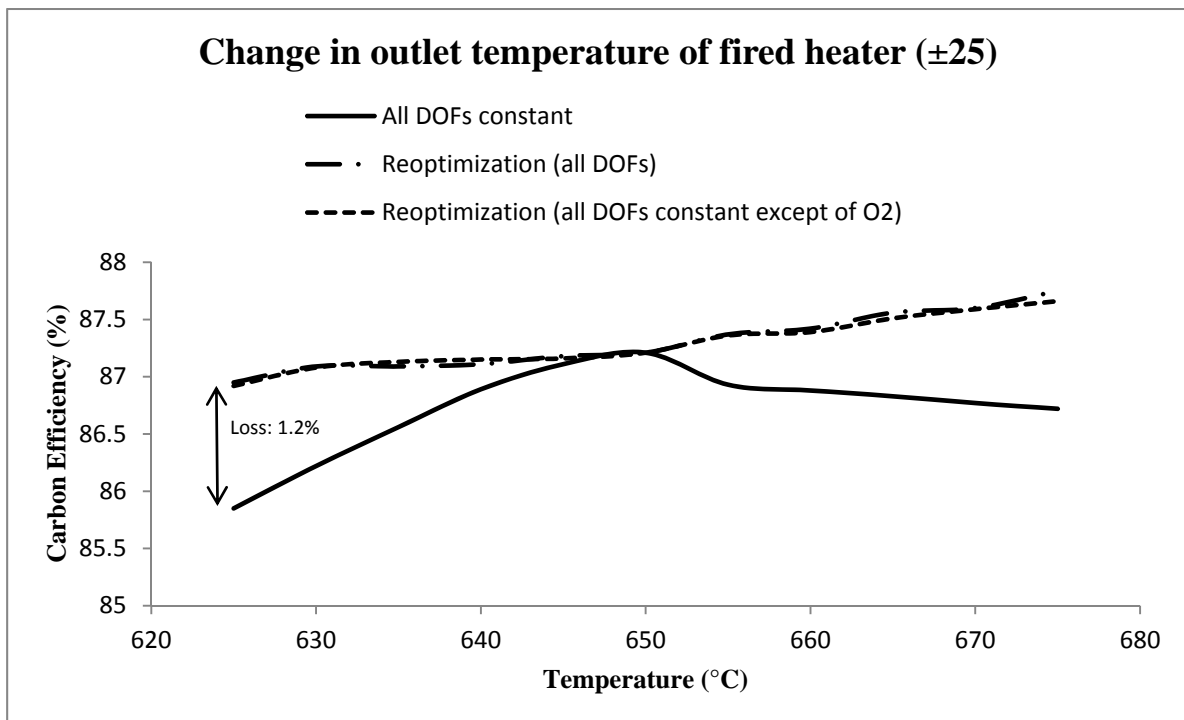

(b)

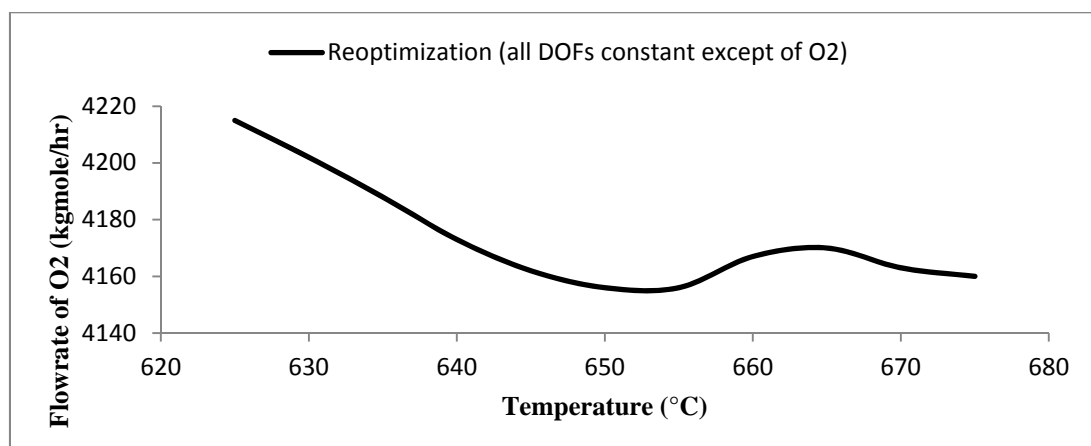

Figure4.5: Change in outlet temperature of fired heater

## Control Structure Design for Methanol Process

Figure 4.5a shows that if the constant degree of freedom policy is used without reoptimizing the process, the loss is 0.57% when the temperature is reduced by 25°C. Reoptimizing the process with all degrees of freedom varying except the flowrate of oxygen gave a loss of 0.13% when the temperature was 625°C.

The loss in objective function associated with the different disturbances are summarised in the table below;

**Table4.3: Summary of worst case losses for various disturbances**

	Disturbance	Worse case of each disturbance		Loss (%) if all DOFs are constant except O2 flowrate
		Change from nominal point	Loss (%)	
1	Natural gas flowrate	+20%	5.09	0.32
2	Natural gas composition	-10%	0.57	0.13
3	outlet temperature of fired heater	-25°C	1.27	0.03

The table clearly shows that we can keep all the degrees of freedom at their optimal nominal point except the flowrate of oxygen and only have an acceptable minimum loss in the objective function without reoptimizing the whole plant when certain disturbances occur. During the optimization of the plant only one constraint was active and that was the outlet temperature of fired heater. This means we are now left to find 6 control variables (CVs) for the 6 unconstrained degrees of freedom (DOFs). Some of the DOF as CVs can be kept at their optimal nominal point but care must be taken to check the effect of implementation error on such variables. Implementation error with respect to a control variable is defined as the difference between its setpoint and its actual value, e.g. due to measurement error or poor controls [24]. The effect of control variable implementation error on the objective function is shown in the table below;

**Table4.4: Effect of CV implementation error on objective function (loss)**

Control variable	Implementation error (%)	Loss (%)
Flowrate of water	-10	0.46
Pressure (syngas part)	-2	0.88
Pressure (methanol part)	-2	<b>2.08</b>
Recycle % to methanol reactor	-15	<b>3.53</b>
Recycle % of pure hydrogen to make-up gas	-15	0.69

## Control Structure Design for Methanol Process

---

From the implementation error analysis we found that the objective function was sensitive to implementation errors in pressure (methanol part) U5 and recycle % of unconverted syngas to the methanol reactor U6. The objective function was however less sensitive to the implantation error as a result of water flowrate U2, pressure (syngas part) U4 and recycle % of pure hydrogen to make-up gas U7. We can conclude up to this point for the self-optimizing control that, it is possible to keep four of the degrees of freedom at their optimal nominal point and they are U2, U3, U4 and U7. This implies that we have three unconstrained degrees of freedom and they are U1, U5 and U6. Therefore there arises the need for us to find the candidate control variables for the unconstrained degrees of freedom.

### 4.1.5 Step 5: Identification of candidate control variables

Table 4.6 shows the selected candidate control variables for the two unconstrained degrees of freedom at the methanol process loop. The unconstrained degree of freedom at the synthesis gas section which is the flowrate of oxygen will be used to control the temperature of the autothermal reactor (ATR).

What should we control to achieve a minimum acceptable loss in the objective function when disturbances occur? This is the question left to be answered in this section. So far this project has outlined 44 candidate measurements from the methanol synthesis part. We are looking at 2 unconstrained degrees of freedom at this point and having 44 measurements will result in;

$$\frac{44 \cdot 43 \cdot 42 \cdot 41 \cdot 40 \cdot \dots \cdot 1}{2.1} = 946 \text{ possible combinations.}$$

It is clearly impossible to evaluate the effects of disturbances and implementation errors for all these possible combinations. Since the composition mole fraction of the purge gas is the same as that of the recycled gas only that of the recycled gas was used for the analysis.

Minimization of the loss  $L$  for any worst-case combination of disturbances and implementation errors is equivalent to minimizing the maximum singular value of  $\bar{\sigma}(M)$ , and that was used to obtain the best candidate sets of controlled variables. The calculation of variables  $S_1$  (total span),  $G$  (steady-state linear matrix) and  $J_{uu}$  (Hessian of unconstrained inputs) are shown at the appendix. Table 4.7 shows the candidate control variables that were chosen with their corresponding nominal optimal point, optimal variation and total span (sum of the optimal variation and implementation error). From table 4.7, about 6 sets of the best



## Control Structure Design for Methanol Process

pairing contains the compressor power for the make-up gas (Y1) being used in controlling the pressure of the methanol reactor.

**Table 4.5: Selected candidate control variables for the methanol process**

Y1	Duty of make-up compressor	Y23	Mole fraction of H <sub>2</sub> O to reactor
Y2	Duty of recycle compressor	Y24	Mole fraction of CH <sub>4</sub> to reactor
Y3	Flowrate of make-up gas	Y25	Mole fraction of H <sub>2</sub> to reactor
Y4	Mole fraction of CO in make-up gas	Y26	Mole fraction of N <sub>2</sub> to reactor
Y5	Mole fraction of CO <sub>2</sub> in make-up gas	Y27	Mole fraction of MeOH out of reactor
Y6	Mole fraction of H <sub>2</sub> O in make-up gas	Y28	Mole fraction of CO out of reactor
Y7	Mole fraction of CH <sub>4</sub> in make-up gas	Y29	Mole fraction of CO <sub>2</sub> out of reactor
Y8	Mole fraction of H <sub>2</sub> in make-up gas	Y30	Mole fraction of H <sub>2</sub> O out of reactor
Y9	Mole fraction of N <sub>2</sub> in make-up gas	Y31	Mole fraction of CH <sub>4</sub> out of reactor
Y10	Flowrate of recycle gas	Y32	Mole fraction of H <sub>2</sub> out of reactor
Y11	Flowrate of purge gas	Y33	Mole fraction of N <sub>2</sub> out of reactor
Y12	Mole fraction of MeOH in recycle gas	Y34	Heat flow from reactor
Y13	Mole fraction of CO in recycle gas	Y35	Flowrate of separator overhead vapour
Y14	Mole fraction of CO <sub>2</sub> in recycle gas	Y36	Mole fraction of MeOH from separator overhead vapour
Y15	Mole fraction of H <sub>2</sub> O in recycle gas	Y37	Mole fraction of CO from separator overhead vapour
Y16	Mole fraction of CH <sub>4</sub> in recycle gas	Y38	Mole fraction of CO <sub>2</sub> from separator overhead vapour
Y17	Mole fraction of H <sub>2</sub> in recycle gas	Y39	Mole fraction of H <sub>2</sub> O from separator overhead vapour
Y18	Mole fraction of N <sub>2</sub> in recycle gas	Y40	Mole fraction of CH <sub>4</sub> from separator overhead vapour
Y19	Flowrate of syngas to reactor	Y41	Mole fraction of H <sub>2</sub> from separator overhead vapour
Y20	Mole fraction of MeOH to reactor	Y42	Mole fraction of N <sub>2</sub> from separator overhead vapour
Y21	Mole fraction of CO to reactor	Y43	Flowrate of liquid outlet from separator
Y22	Mole fraction of CO <sub>2</sub> to reactor	Y44	Flowrate out of reactor

The flowrate of the recycle and purge gas were also included as one of the best candidates for the split ratio. The other choices are also reasonable to consider that is set (7 – 16) as shown in table 4.7.

### 4.1.6 Step 6: Detailed evaluation of loss

The next step is to evaluate the loss associated with the promising candidate set of control variables in table 4.8 by keeping the constant setpoint policy in the presence of disturbances and implementation errors. The computations were performed using dedicated Matlab code developed by Vinay Kariwala. As can be seen from the table the set with the minimum loss is

## Control Structure Design for Methanol Process

the best to consider. Set 1 directs us to use the compressor power for the control of the pressure and also by flow-controlling the flowrate of the purge stream it will be possible to control the split ratio.

**Table 4.6: Candidate control variables with small losses in local analysis**

Variable	Name	Optimal nominal	Optimal variation	Implementation error	Total span
Y1	Duty of make-up compressor [kW]	22355.29	79.33	1117.76	1197.09
Y10	Flowrate of recycle gas [kgmol/hr]	56456.04	51450.56	5645.60	57096.16
Y11	Flowrate of purge gas [kgmol/hr]	3924.75	-778.74	392.48	-386.27
Y12	Mole fraction of MeOH in recycle gas	0.0056	0.00039	0.00056	0.00095
Y13	Mole fraction of CO in recycle gas	0.2124	0.0095	0.0212	0.0375
Y18	Mole fraction of N <sub>2</sub> in recycle gas	0.0109	0.1331	0.00109	0.1342
Y22	Mole fraction of CO <sub>2</sub> to reactor	0.0767	0.01148	0.00767	0.01915
Y26	Mole fraction of N <sub>2</sub> to reactor	0.00836	0.12168	0.00084	0.1225
Y28	Mole fraction of CO out of reactor	0.19164	0.01249	0.0192	0.03165
Y33	Mole fraction of N <sub>2</sub> out of reactor	0.00985	0.12929	0.00098	0.13018
Y34	Heat flow from reactor [kW]	174235.19	21027.77	8711.76	29739.52
Y36	Mole fraction of MeOH from separator overhead vapour	0.0056	0.00039	0.00056	0.00095
Y37	Mole fraction of CO from separator overhead vapour	0.0109	0.1331	0.00109	0.13424
Y42	Mole fraction of N <sub>2</sub> from separator overhead vapour	6619.85	744.58	661.99	1406.56
Y43	Flowrate of liquid outlet from separator [kgmol/hr]	22355.29	79.33	1117.76	1197.09

The final evaluation and control structure involves the selection of the sets of controlled variables with acceptable loss, such as the ones shown in table 4.7. Dynamic control performance (input-output controllability) will be used to analyse the results discovered by the self-optimizing control approach.

The procedure used for finding the maximum singular value  $\bar{\sigma}(\mathbf{M})$  and the loss  $L$  is shown at the appendix.

# Control Structure Design for Methanol Process

**Table4.7: Maximum singular values for unconstrained control variables**

Set	Variable 1	Variable 2	$\bar{\sigma}(M)$	Loss (L)
1	Y1	Y11	0.957497	0.4584
2	Y1	Y18	1.014889	0.515
3	Y1	Y42	1.014889	0.515
4	Y1	Y33	1.190378	0.7085
5	Y1	Y22	1.388380	0.9638
6	Y1	Y26	1.410957	0.9954
7	Y28	Y34	1.598562	1.2777
8	Y12	Y43	1.849108	1.7096
9	Y36	Y43	1.849108	1.7096
10	Y12	Y34	1.850027	1.7113
11	Y34	Y36	1.850027	1.7113
12	Y37	Y43	1.896787	1.7989
13	Y13	Y43	1.897156	1.7996
14	Y1	Y43	1.902630	1.8100
15	Y26	Y37	1.905256	1.8150
16	Y13	Y26	1.905571	1.8156

## 4.2 Dynamic Simulation

Before the steady-state simulation was transformed into dynamics, equipment sizing was carried out. All the separators were sized with 5 min residence time and a 50% liquid level. The calculation of the size of the separator was based on the superficial vapour velocities, using gas flowrate and density. The size of the methanol reactor was known from the steady state model. The size of the pre-reformer and the autothermal reactors were sized in the same way as the separators but without a liquid holdup amount. The heat exchangers on the other hand were sized with 10 min liquid holdup time.

The instability associated with the level of the condenser, reboiler and separators are stabilized by using its outlet liquid flow rate with a P – controller. As explained earlier the reactor is normally unstable and has some oscillations in its outlet temperature and this affects the inlet pressure or temperature as a result. It has been suggested by [2] to control the reaction temperature by controlling the pressure of the boiling water. Besides this pressure loop a level controller is used to control the water level in the steam drum. Control structures were also set for all the variables that were specified during the steady-state simulation. All these constitute the regulatory layer control.

## Control Structure Design for Methanol Process

---

The figure shown in the dynamic mode is a little different from the steady-state model because we wanted to simplify the process. The distillation columns and the splitter was removed.

### 4.2.2 Tuning of controllers

The selected regulatory loops are first of all closed and tuned individually starting with the fastest loops. Step tests were performed on the control variables ( $y$ ) by making changes in the manipulating variables ( $u$ ). The model parameters recorded are used to tune the controllers by using the SIMC tuning rules [26] to design PI-controllers:

$$K_c = \frac{1}{k} \frac{\tau}{\tau_c + \theta} ; \tau_I = \min\{\tau_1, 4(\tau_c + \theta)\}$$

where  $k$ ,  $\tau$ ,  $\tau_c$  and  $\theta$  are the gain, time constant, tuning parameter (desired closed loop time constant) and effective delay respectively. In this process  $\tau_c = \theta$ , for robustness. The gain  $K_c$  and integral time  $\tau_I$  for the regulatory controllers are shown in the table below;

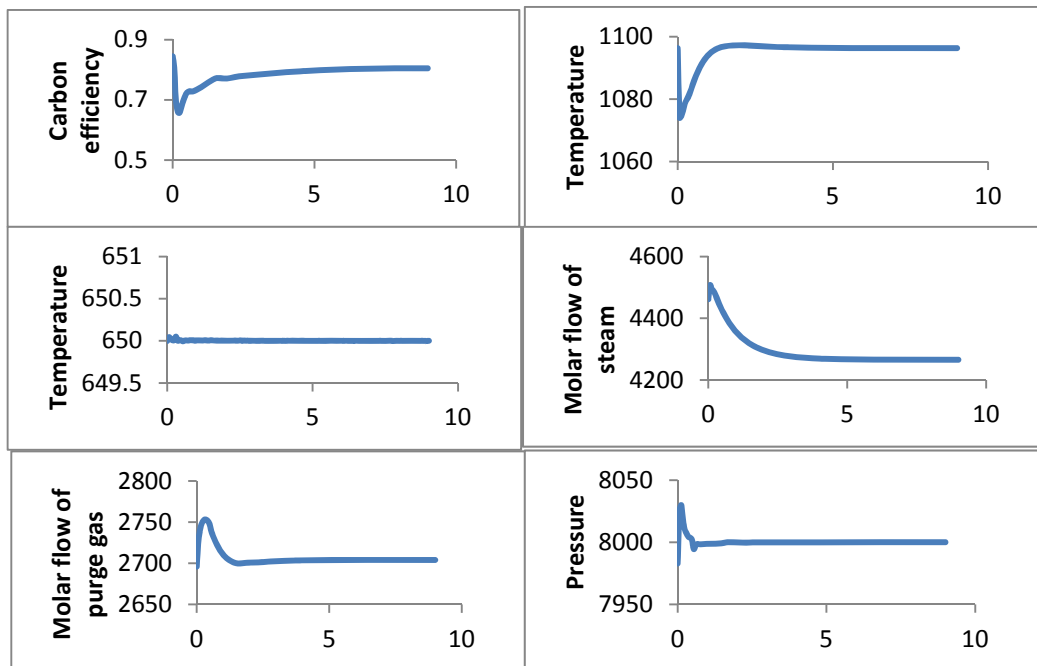

Figure 4.6: Setpoint of control variables

Figure 4.6 shows the setpoint of the control variables when no disturbance has occur for about 2.5hrs.

## Control Structure Design for Methanol Process

The graphs shows the objective function, temperature of the ATR, outlet temperature of the fired heater, molar flow of steam, molar flow of purge gas and pressure of the make-up gas and recycle gas.

Although the process was separated, the effect of disturbances on the process was used to validate the control scheme proposed for the different parts. The first was a 10% decrease in the natural flowrate (from 7300 to 6570). The responses are shown in the figure below;

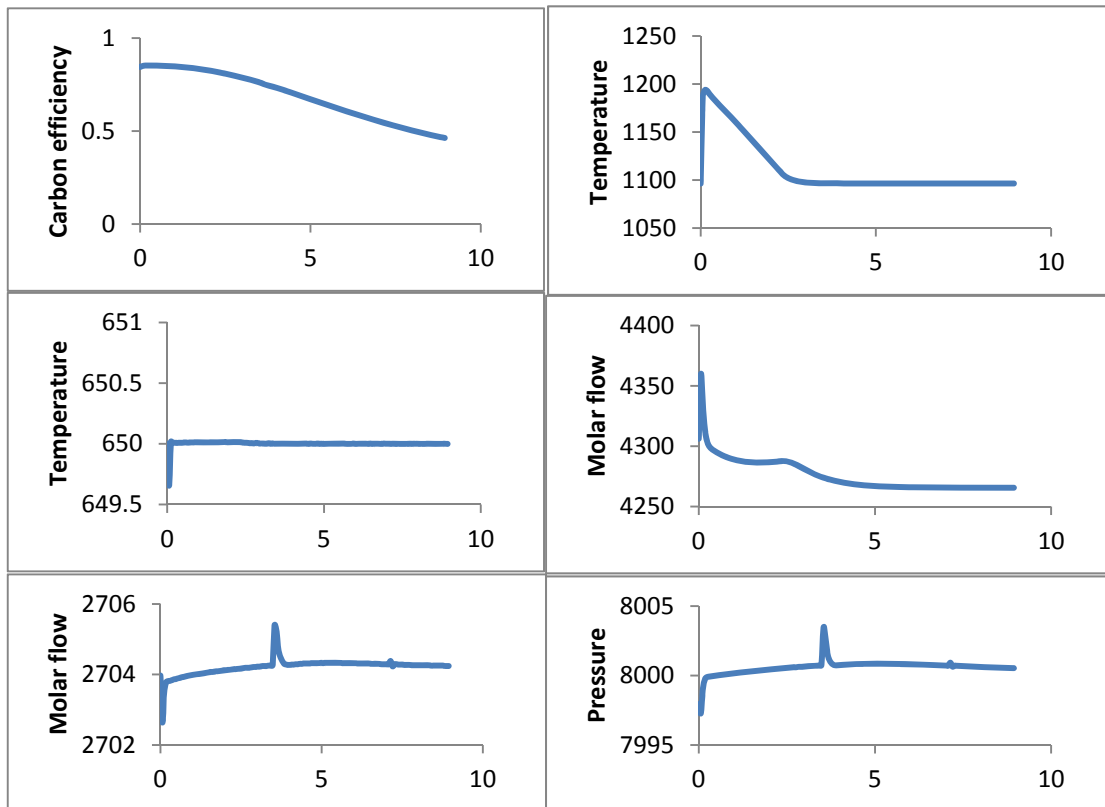
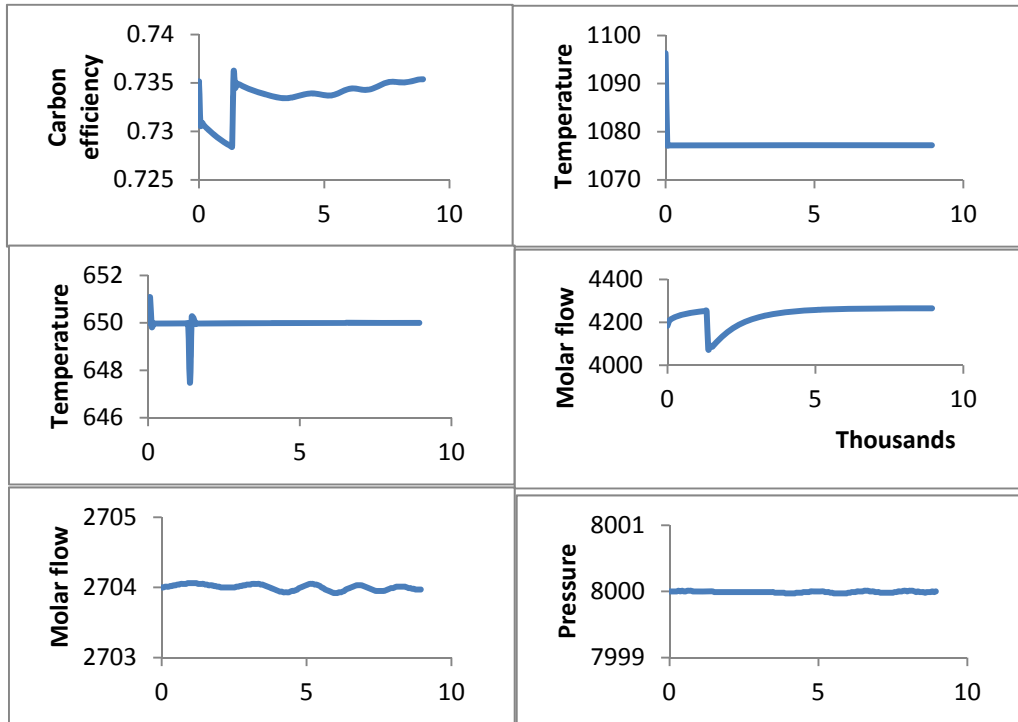

Figure4.7: 10% decrease in natural gas flowrate

From the figure above the objective function is decreasing rapidly, this is because of the outlet temperature of the methanol reactor not being controlled. The other control variables seem to drift away from their setpoint but come back after a certain period of time.

## Control Structure Design for Methanol Process

The next figure shows the response when the natural gas molar flow is increased by 10% (from 7300 to 8030).



**Figure 4.8: 10% increase in natural gas flowrate**

The temperature of the ATR assumes a new steady-state value ( $1077^{\circ}\text{C}$ ) when the natural molar flow increases. The pressure of the make-up gas and recycle gas tends to fluctuate around the setpoint.

The response of the control variables when the composition of the natural gas changes is shown in figure 4.9. Clearly, all the controllers work perfectly when the composition of natural gas changes. The only problem is that the objective function seems to decrease very rapidly but this is caused by the uncontrolled temperature out of the methanol reactor.

# Control Structure Design for Methanol Process

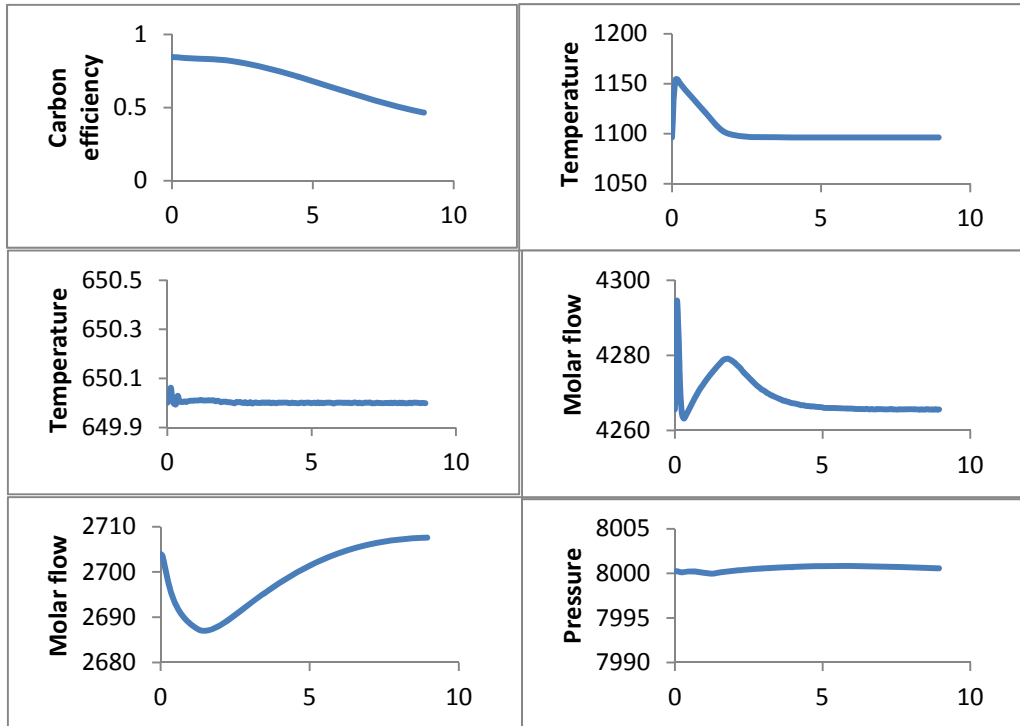

Figure 4.9: 5% change in natural gas composition

# Control Structure Design for Methanol Process

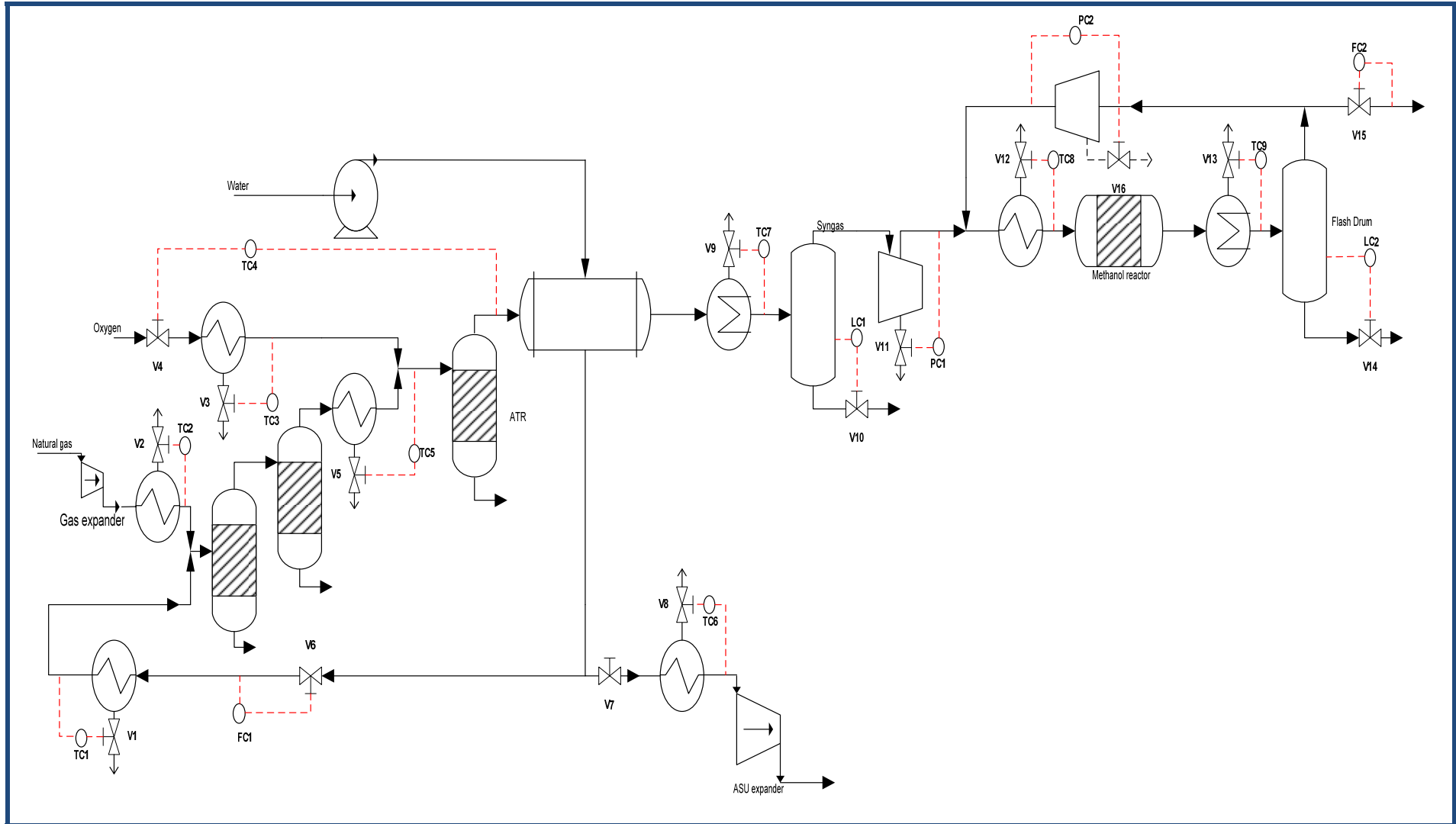

Figure 4.10: Plant wide control structure



## Control Structure Design for Methanol Process

**Table4.8: Controller parameters**

Tag	Input	Output	Set point	PI-controller parameters	
				Kc	$\tau_i$ (min)
FC1	V6	F <sub>super heated steam</sub> [kgmol/hr]	4266	0.6	5
FC2	V15	F <sub>purge gas</sub> [kgmol/hr]	2704	0.6	5
TC1	V1	T <sub>superheated steam</sub> [°C]	496.9	0.1	0.1
TC2	V2	T <sub>preheated natural gas</sub> [°C]	496.9	0.1	0.5
TC3	V3	T <sub>preheated oxygen</sub> [°C]	200	0.1	0.1
TC4	V4	T <sub>outlet of ATR</sub> [°C]	1095	0.01	0.45
TC5	V5	T <sub>inlet to ATR</sub> [°C]	650	0.1	0.1
TC6	V8	T <sub>steam for ASU</sub> [°C]	400	0.1	0.1
TC7	V9	T <sub>inlet to separator</sub> [°C]	20	0.05	2
TC8	V12	T <sub>inlet of methanol reactor</sub> [°C]	270	0.1	0.5
TC9	V13	T <sub>inlet to flash drum</sub> [°C]	40	0.05	2
PC1	V11	P <sub>make-up gas</sub> [kPa]	8000	0.7	0.3
PC2	V16	P <sub>recycle gas</sub> [kPa]	8000	0.7	0.3
LC1	V10	L <sub>separator</sub> [%]	50	2	
LC2	V14	L <sub>flash drum</sub> [%]	50	2	

NB: F, T, P, and L stands for flowrate, temperature, pressure and level respectively.

## Chapter 5

### Conclusion and further work

#### 5.1 Conclusion

The simulation of the methanol plant in UniSim™ imposed some challenges for this thesis but yet still a near accurate model was simulated. We can boldly say that the first aim for this thesis was achieved. Although there were some problems with the best kinetics to be chosen for the methanol formation, the kinetics proposed by Vanden Bussche and Froment proved to give a better results.

The area of optimization and controllability of the manufacturing plants still remains a bigger challenge for many industries today. In this thesis, the methodology used for the optimization incorporates several issues like economics, environmental and operational considerations for the process. The process was optimized with about 7 degrees of freedom which is known to have adverse effects on the carbon efficiency (objective function) was considered. UniSim™ optimizer was used to carry out this operation. The 7 degrees of freedom were flow rates of water and oxygen, pressure at the syngas and methanol synthesis part, inlet temperature to the ATR, the amount unreacted syngas recycled to the reactor and the amount of pure hydrogen recycled to the process. After the optimization, the optimal nominal values for these manipulated variables were found and used for further analysis. The idea of self-optimizing approach was carried out, it was discovered that keeping the all the degrees of freedom except the flow rate of oxygen gave an acceptable loss when disturbances occur. This means there will be no need to reoptimized the whole plant again when disturbances was to happen.

Another test was also carried out on the 6 decision variables left, and that was the effect of implementation error. It was realized that implementation error has some effect on two of the remaining degrees of freedom; and these were the pressure at the methanol part and the recycle of unconverted syngas to the methanol reactor. This means we have four constrained degrees of freedom and three unconstrained degrees of freedom for the plant based on the manipulated variables selected for the optimization.

The next step was to select candidate control variables for these unconstrained degrees of freedom. As it is always said in process control 'active constraints should be controlled'.

## Control Structure Design for Methanol Process

---

Insight from the process simulation suggested that; the flowrate of oxygen can be controlled with the outlet temperature from the autothermal reformer. About 44 possible candidates were selected for the other two remaining unconstrained degrees of freedom. The exact local method, as described in chapter 4 of this thesis was used to select some candidate sets for the process. The best pairing was the work of the compressor and the flowrate of the purge gas.

Dynamic evaluation and plant-wide control were integrated within the framework to assess the operability and controllability of the plant. Control in plant-wide perspective forms the final stage of the process synthesis, design and operation assessments. A simplified dynamic model was used to implement and validate overall dynamic performances of the plant. However the dynamic simulation failed to work in UniSim™ when the whole plant is analysed but seems to work fine when they are in separate parts namely syngas and methanol synthesis part. Further tests were performed on the different parts but since it was impossible to test the control structure of the entire plant it made it very difficult to conclude whether the control structure developed is really the best one for such a process.

### 5.2 Future Recommendation

Although a great deal of effort and some significant results were achieved in this thesis, but there is still a number of potential areas that is to be considered and addressed for further investigations. Outlined below are some of the future potential areas that can still be harnessed for this process;

1. Heat integration should be considered for this process.
2. Self-optimizing control in the dynamic mode should be considered in the near future
3. Mode II self-optimizing control proposed by (Skogestad, 2004) should be applied for this process
4. A different dynamic simulation software like Aspen dynamics™ should be used for the dynamics of the plant.
5. It was observed during the dynamic simulation that the pressure for the methanol synthesis loop was very difficult to control; therefore a more realistic way of using the compressor power for control is by using compressor curves and then specifying the speed of the compressor instead of the head and efficiency specification used in this thesis.

## Control Structure Design for Methanol Process

---

6. The outlet temperature of the methanol reactor should be controlled by controlling the temperature of the produced steam. I was unable to control this temperature because of the instability in the process.

# Control Structure Design for Methanol Process

---

## REFERENCES

- [1] K. Aasberg-Petersen, J. H. B. H., T.S. Christensen, I. Dybkjaer, P. Seier Christensen, C. Stub Nielsen, S.E.L. Winter Madsen, J.R. Rostrup-Nielsen (2001). "Technologies for large-scale gas conversion." Applied Catalysis **1**.
- [2] M. Shahrokhi, G. R. B. (2005). "Modeling, simulation and control of a methanol synthesis fixed-bed reactor." Chemical Engineering Science.
- [3] Higman, C. (1990). Synthesis Gas Processes for Synfuels Production. EUROGAS '90. Trondheim.
- [4] Froment G.F, K. M. Vanden Bussche (1996). "A Steady-State Kinetic Model for Methanol Synthesis and the Water Gas Shift Reaction on a Commercial Cu/ZnO/Al<sub>2</sub>O<sub>3</sub> Catalyst." Catalysis **161**.
- [5] Ali Elkamel, G. R. Z., Chris Marton and Ali Lohi (2009). "Optimal Fixed Bed Reactor Network Configuration for the Efficient Recycling of CO<sub>2</sub> into Methanol." Energies: 180-189.
- [6] Perregaard, J. (2005). "Methanol synthesis at near-critical conditions combined with ATR synthesis gas technology  
The technology choice for large-scale methanol production." Catalysis Today: 99-102
- [7] Chul-Jin Lee, Y. L., Ho Soo Kim, and Chonghun Han (2008). "Optimal Gas-To-Liquid Product Selection from Natural Gas under Uncertain Price Scenarios." Industrial & Engineering Chemistry Research: 794-800.
- [8] M.R. Rahimpour, H. E. B. (2008). "Dynamic optimization of membrane dual-type methanol reactor in the presence of catalyst deactivation using genetic algorithm." Fuel Processing Technology.
- [9] M.R. Rahimpour, M. L. (2007). "A comparison of co-current and counter-current modes of operation for a dual-type industrial methanol reactor." Chemical Engineering and Processing **47**: 1819-1830.
- [10] G.H. Graaf, H. S., E.J. Stamhuis and A.A.C.M. Beenackers (1989). "Intra-Particle Diffusion Limitations in Low-Pressure Methanol Synthesis." Chemical Engineering Science **45**: 773-783.
- [11] M.H. Khademi, P. S., M.R. Rahimpour, A. Jahanmiri (2009). "Optimization of methanol synthesis and cyclohexane dehydrogenation in a thermally coupled reactor using differential evolution (DE) method." Hydrogen Energy **34**: 6930-6944.
- [12] Jacob A. Moulijn, M. M., and Annelies Van Diepen (2001). Chemical Process Technology, John Wiley & Sons, Ltd.
- [13] Mr. M. R. Patel, Mr. C. N. Shah., and Mr. BPS. Mehta "Pre-reformer, the solution for increasing plant throughput."

## Control Structure Design for Methanol Process

---

- [14] Lee, S. (1990). Methanol Synthesis Technology, CRC Press.
- [15] Wu-Hsun Cheng and Harold H. Kung Ed. (1994). Methanol Production and Use Chemical Industries, CRC Press.
- [16] D.J. Wilhelm, D. R. S., A.D. Karp, R.L. Dickenson (2001). "Syngas production for gas-to-liquids applications: technologies, issues and outlook." Fuel Processing Technology **71**: 139 - 148.
- [17] Sigurd Skogestad (2000). Plantwide control: the search for the self-optimizing control structure. "Journal of Process Control" **10**: 487 – 507.
- [18] S. Skogestad and I. Postlethwaite (2005). Multivariable Feedback Control, 2nd edition, John Wiley & Sons Ltd.
- [19] I.L. Greeff, J.A. Visser, K.J. Ptasinski, F.J.J.G Janssen (2002). "Utilization of reactor heat in methanol synthesis to reduce compressor duty-application of power cycle principles and simulation tools." Applied Thermal Engineering" **22**: 1549 – 1558.
- [20] <http://www.naturalgas.org>
- [21] US energy Information and administration
- [22] Cao, Y., D. Rossiter and D. Owens (1998a). Globally optimal control structure selection using branch and bound method. In: Proceedings of DYCOPS-5, 5th IFAC Symposium on Dynamics and Control of Process Systems. Corfu, Greece.
- [23] Kim Aasberg-Pettersen, Charlotte Stub Nielsen, Lb Dybkjær and Jens Perregaard (2009). "Large scale methanol synthesis from natural gas": 1 – 14.
- [24] PhD thesis by Antonio Carlos Brandao de Araujo "Studies on plantwide control".
- [25] Halvorsen, I J., S. Skogestad, J. C. Morud and V. Alstad (2003). Optimal selection of controlled variables. *Ind. Eng. Chem. Res.* **42**, 3273–3284.
- [26] Simple analytic rules for model reduction and PID controller tuning. *Journal of Process control* **28**, 219 – 309.
- [27] Control structure design for complete chemical plants. *Computers and Chemical Engineering Journal* **28** (2004), 219 – 234.

## APPENDIX

### A: Kinetics applied in UniSim™

Vanden Bussche and Froment

Two independent reactions (hydrogenation of carbon monoxide and the reverse water gas shift) were considered out of the three following dependent reactions:

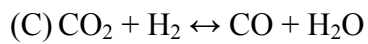
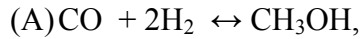

The table below shows the kinetic and equilibrium constants

$k = A \exp(B/R_g T)$	A	B
$k_a (\text{bar}^{-1/2})$	0.499	17197
$k_b (\text{bar}^{-1})$	$6.62 \times 10^{-11}$	124119
$k_c$	3453.38	-
$k_d (\text{mol/kg s bar}^2)$	1.07	36696
$k_e (\text{mol/kg s bar})$	$1.22 \times 10^{10}$	-94765
$K^{eq} = 10^{\left(\frac{A}{T} - B\right)}$	A	B
$K_1^{eq} (\text{bar}^{-2})$	3066	10.592
$K_2^{eq}$	2073	2.029

$$K_1^{eq} = 10^{\left(\frac{3066}{T} - 10.592\right)}$$

$$\ln K_1^{eq} = \ln 10^{\left(\frac{3066}{T} - 10.592\right)}$$

$$\ln K_1^{eq} = 2.3 \left( \frac{3066 \times 8.314}{RT} - 10.592 \right)$$

$$\ln K_1^{eq} = \left( \frac{58629}{RT} - 24.36 \right)$$

$$K_1^{eq} = e^{\left(\frac{58629}{RT} - 24.36\right)}$$

$$K_1^{eq} = 2.63 \times 10^{-11} e^{\left(\frac{58629}{RT}\right)}$$

$$K_2^{eq} = 10^{\left(\frac{2073}{T} - 2.029\right)}$$

$$\ln K_2^{eq} = \ln 10^{\left(\frac{2073}{T} - 2.029\right)}$$

$$\ln K_2^{eq} = 2.3 \left( \frac{2073 \times 8.314}{RT} - 2.029 \right)$$

$$\ln K_2^{eq} = \left( \frac{39640}{RT} - 4.67 \right)$$

$$K_2^{eq} = e^{\left(\frac{39640}{RT} - 4.67\right)}$$

$$K_2^{eq} = 9.37 \times 10^{-3} e^{\left(\frac{39640}{RT}\right)}$$

The rates of reaction proposed by Vanden Bussche and Froment according to reaction (B) and (C) are given below;

### CO<sub>2</sub> hydrogenation

$$r_B = \frac{k_d P_{CO_2} P_{H_2} \left( 1 - \left( \frac{1}{K_1^{eq}} \right) (P_{H_2O} P_{CH_3OH} / P_{H_2}^3 P_{CO_2}) \right)}{\left( 1 + \frac{k_c P_{H_2O}}{P_{H_2}} + k_a \sqrt{P_{H_2}} + k_b P_{H_2O} \right)^3}$$

$$r_B = \frac{k_d P_{CO_2} P_{H_2} - \frac{k_d}{K_1^{eq}} \frac{P_{H_2O} P_{CH_3OH}}{P_{H_2}^2}}{\left( 1 + \frac{k_c P_{H_2O}}{P_{H_2}} + k_a \sqrt{P_{H_2}} + k_b P_{H_2O} \right)^3}$$

$$\frac{k_d}{K_1^{eq}} = \frac{1.07 \exp\left(\frac{36696}{RT}\right)}{2.63 \times 10^{-11} \exp\left(\frac{58629}{RT}\right)} = 4.07 \times 10^{10} \exp\left(\frac{-21933}{RT}\right)$$



$$r_B = \frac{1.07 \exp\left(\frac{36696}{RT}\right) P_{CO_2} P_{H_2} - 4.07 \times 10^{10} \exp\left(\frac{-21933}{RT}\right) \frac{P_{H_2O} P_{CH_3OH}}{P_{H_2}^2}}{\left(1 + 3453.38 \exp\left(\frac{0}{RT}\right) \frac{P_{H_2O}}{P_{H_2}} + 0.499 \exp\left(\frac{17197}{RT}\right) \sqrt{P_{H_2}} + 6.62 \times 10^{-11} \exp\left(\frac{124119}{RT}\right) P_{H_2O}\right)^3} \frac{mol}{kgcat \cdot s}$$

$$\times 1775 \frac{kgcat}{m^3 cat} \times \frac{1 kmol}{1000 mol} \times \frac{(1 - 0.39) m_{cat}^3}{m_R^3}$$

$r_B$

$$= \frac{1.16 \exp\left(\frac{36696}{RT}\right) P_{CO_2} P_{H_2} - 4.41 \times 10^{10} \exp\left(\frac{-21933}{RT}\right) \frac{P_{H_2O} P_{CH_3OH}}{P_{H_2}^2}}{\left(1 + 3453.38 \exp\left(\frac{0}{RT}\right) \frac{P_{H_2O}}{P_{H_2}} + 0.499 \exp\left(\frac{17197}{RT}\right) \sqrt{P_{H_2}} + 6.62 \times 10^{-11} \exp\left(\frac{124119}{RT}\right) P_{H_2O}\right)^3} \frac{kgmol}{m_R^3 \cdot s}$$

### Reverse water gas shift reaction (RWGS)

$$r_C = \frac{k_e P_{CO_2} \left(1 - K_2^{eq} (P_{H_2O} P_{CO} / P_{H_2} P_{CO_2})\right)}{1 + \frac{k_c P_{H_2O}}{P_{H_2}} + k_a \sqrt{P_{H_2}} + k_b P_{H_2O}}$$

$$r_C = \frac{k_e P_{CO_2} - k_e K_2^{eq} \frac{P_{H_2O} P_{CO}}{P_{H_2}}}{1 + \frac{k_c P_{H_2O}}{P_{H_2}} + k_a \sqrt{P_{H_2}} + k_b P_{H_2O}}$$

$$k_e K_2^{eq} = 1.22 \times 10^{10} \exp\left(-\frac{94765}{RT}\right) 9.37 \times 10^{-3} \exp\left(\frac{39640}{RT}\right)$$

$$= 1.14 \times 10^8 \exp\left(-\frac{55125}{RT}\right)$$

$$r_C = \frac{1.22 \times 10^{10} \exp\left(-\frac{94765}{RT}\right) P_{CO_2} - 1.14 \times 10^8 \exp\left(-\frac{55125}{RT}\right) \frac{P_{H_2O} P_{CO}}{P_{H_2}}}{1 + 3453.38 \exp\left(\frac{0}{RT}\right) \frac{P_{H_2O}}{P_{H_2}} + 0.499 \exp\left(\frac{17197}{RT}\right) \sqrt{P_{H_2}} + 6.62 \times 10^{-11} \exp\left(\frac{124119}{RT}\right) P_{H_2O}} \frac{mol}{kgcat \cdot s}$$

$$\times 1775 \frac{kgcat}{m^3 cat} \times \frac{1 kmol}{1000 mol} \times \frac{(1 - 0.39) m_{cat}^3}{m_R^3}$$

$$r_C = \frac{1.32 \times 10^{10} \exp\left(-\frac{94765}{RT}\right) P_{CO_2} - 1.23 \times 10^8 \exp\left(-\frac{55125}{RT}\right) \frac{P_{H_2O} P_{CO}}{P_{H_2}}}{1 + 3453.38 \exp\left(\frac{0}{RT}\right) \frac{P_{H_2O}}{P_{H_2}} + 0.499 \exp\left(\frac{17197}{RT}\right) \sqrt{P_{H_2}} + 6.62 \times 10^{-11} \exp\left(\frac{124119}{RT}\right) P_{H_2O}} \frac{kgmol}{m_R^3 \cdot s}$$

B: Stream table for nominally optimal operating point for the methanol process (refer to fig. 3.2 for stream names)

1	 Norwegian University of Science and Trondheim Norway		Case Name: E:\Thesis\Methanol process simulation.usc		
2			Unit Set: optimizer		
3			Date/Time: Tuesday Jun 8 2010, 23:38:16		
4					
5					
6	<b>Workbook: Case (Main)</b>				
7					
8					
9	<b>Streams</b>				Fluid Pkg: All
10					
11	Name	Natural gas	expanded gas	Preheated gas	Superheated steam 4
12	Vapour Fraction	1.0000	1.0000	1.0000	1.0000
13	Temperature (C)	50.00 *	0.1748	496.9 *	496.9 *
14	Pressure (kPa)	7000 *	3000	3000	4000
15	Molar Flow (kgmole/h)	7300 *	7300	7300	4266
16	Mass Flow (tonne/d)	2951	2951	2951	1844
17	Std Ideal Liq Vol Flow (m3/h)	399.7	399.7	399.7	77.00
18	Heat Flow (kJ/h)	-5.492e+008	-5.595e+008	-3.757e+008	-9.631e+008
19	Molar Enthalpy (kJ/kgmole)	-7.524e+004	-7.664e+004	-5.147e+004	-2.258e+005
20	Comp Mole Frac (Methanol)	0.0000 *	0.0000	0.0000	0.0000
21	Comp Mole Frac (CO)	0.0000 *	0.0000	0.0000	0.0000
22	Comp Mole Frac (CO2)	0.0000 *	0.0000	0.0000	0.0000
23	Comp Mole Frac (H2O)	0.0000 *	0.0000	0.0000	1.0000
24	Comp Mole Frac (Methane)	0.9550 *	0.9550	0.9550	0.0000
25	Comp Mole Frac (Hydrogen)	0.0000 *	0.0000	0.0000	0.0000
26	Comp Mole Frac (Ethane)	0.0300 *	0.0300	0.0300	0.0000
27	Comp Mole Frac (Propane)	0.0050 *	0.0050	0.0050	0.0000
28	Comp Mole Frac (n-Butane)	0.0040 *	0.0040	0.0040	0.0000
29	Comp Mole Frac (Nitrogen)	0.0060 *	0.0060	0.0060	0.0000
30	Comp Mole Frac (Oxygen)	0.0000 *	0.0000	0.0000	0.0000
31					
32					
33	Honeywell International Inc.		UniSim Design (R380 Build 14027)		Page 1 of 20

Licensed to: Norwegian University

Printed by: Theophilus Arthur

\* Specified by user.

1		Norwegian University of Science and Trondheim Norway	Case Name: E:\Thesis\Methanol process simulation.usc			
2			Unit Set: optimizer			
3			Date/Time: Tuesday Jun 8 2010, 23:38:16			
4						
5						
6	<b>Workbook: Case (Main) (continued)</b>					
7						
8						
9	<b>Streams (continued)</b>				Fluid Pkg:	All
10						
11	Name	Dummy liquid	Dummy liquid 2	5	6	Dummy liquid 3
12	Vapour Fraction	0.0000	0.0000	1.0000	1.0000	0.0000
13	Temperature (C)	291.0	446.5	446.5	1095	1095
14	Pressure (kPa)	3000	3000	3000	3000	3000
15	Molar Flow (kgmole/h)	0.0000	0.0000	1.216e+004	2.644e+004	0.0000
16	Mass Flow (tonne/d)	0.0000	0.0000	4795	7886	0.0000
17	Std Ideal Liq Vol Flow (m3/h)	0.0000	0.0000	500.1	786.4	0.0000
18	Heat Flow (kJ/h)	0.0000	0.0000	-1.339e+009	-1.123e+009	0.0000
19	Molar Enthalpy (kJ/kgmole)	-2.600e+005	-1.101e+005	-1.101e+005	-4.249e+004	-4.249e+004
20	Comp Mole Frac (Methanol)	0.0000	0.0000	0.0000	0.0000	0.0000
21	Comp Mole Frac (CO)	0.0010	0.0006	0.0006	0.2488	0.2488
22	Comp Mole Frac (CO2)	0.0000	0.0239	0.0239	0.0325	0.0325
23	Comp Mole Frac (H2O)	0.9898	0.3025	0.3023	0.1520	0.1520
24	Comp Mole Frac (Methane)	0.0060	0.6031	0.6033	0.0075	0.0075
25	Comp Mole Frac (Hydrogen)	0.0031	0.0663	0.0663	0.5575	0.5575
26	Comp Mole Frac (Ethane)	0.0000	0.0000	0.0000	0.0000	0.0000
27	Comp Mole Frac (Propane)	0.0000	0.0000	0.0000	0.0000	0.0000
28	Comp Mole Frac (n-Butane)	0.0000	0.0000	0.0000	0.0000	0.0000
29	Comp Mole Frac (Nitrogen)	0.0000	0.0036	0.0036	0.0017	0.0017
30	Comp Mole Frac (Oxygen)	0.0000	0.0000	0.0000	0.0000	0.0000
31						
32						
33	Honeywell International Inc.		UniSim Design (R380 Build 14027)		Page 2 of 20	

1		Norwegian University of Science and Trondheim Norway	Case Name: E:\Thesis\Methanol process simulation.usc			
2			Unit Set: optimizer			
3			Date/Time: Tuesday Jun 8 2010, 23:38:16			
4						
5						
6	<b>Workbook: Case (Main) (continued)</b>					
7						
8	<b>Streams (continued)</b>					
9						Fluid Pkg: All
10						
11	Name	Oxygen	Preheated_oxygen	3	7	Syngas
12	Vapour Fraction	1.0000	1.0000	1.0000	0.8487	1.0000
13	Temperature (C)	5.000 *	200.0 *	733.9	20.00 *	20.00
14	Pressure (kPa)	3000	3000	3000	3000	3000
15	Molar Flow (kgmole/h)	4024 *	4024	1.216e+004	2.644e+004	2.244e+004
16	Mass Flow (tonne/d)	3090	3090	4795	7886	6155
17	Std Ideal Liq Vol Flow (m3/h)	113.2	113.2	500.1	786.4	714.1
18	Heat Flow (kJ/h)	-3.469e+006	2.087e+007	-1.144e+009	-2.235e+009	-1.088e+009
19	Molar Enthalpy (kJ/kgmole)	-862.1	5186	-9.408e+004	-8.455e+004	-4.850e+004
20	Comp Mole Frac (Methanol)	0.0000 *	0.0000	0.0000	0.0000	0.0000
21	Comp Mole Frac (CO)	0.0000 *	0.0000	0.0006	0.2488	0.2932
22	Comp Mole Frac (CO2)	0.0000 *	0.0000	0.0239	0.0325	0.0382
23	Comp Mole Frac (H2O)	0.0000 *	0.0000	0.3023	0.1520	0.0009
24	Comp Mole Frac (Methane)	0.0000 *	0.0000	0.6033	0.0075	0.0089
25	Comp Mole Frac (Hydrogen)	0.0000 *	0.0000	0.0663	0.5575	0.6569
26	Comp Mole Frac (Ethane)	0.0000 *	0.0000	0.0000	0.0000	0.0000
27	Comp Mole Frac (Propane)	0.0000 *	0.0000	0.0000	0.0000	0.0000
28	Comp Mole Frac (n-Butane)	0.0000 *	0.0000	0.0000	0.0000	0.0000
29	Comp Mole Frac (Nitrogen)	0.0000 *	0.0000	0.0036	0.0017	0.0020
30	Comp Mole Frac (Oxygen)	1.0000 *	1.0000	0.0000	0.0000	0.0000
31						
32						
33	Honeywell International Inc.		UniSim Design (R380 Build 14027)		Page 3 of 20	

1	 Norwegian University of Science and Trondheim Norway		Case Name: E:\Thesis\Methanol process simulation.usc			
2			Unit Set: optimizer			
3			Date/Time: Tuesday Jun 8 2010, 23:38:16			
4						
5						
6	<b>Workbook: Case (Main) (continued)</b>					
7						
8						
9	<b>Streams (continued)</b>				Fluid Pkg: All	
10						
11	Name	9	Make-up gas	12	13	14
12	Vapour Fraction	0.0000	1.0000	1.0000	1.0000	1.0000
13	Temperature (C)	20.00	140.7	63.70	255.0	270.0
14	Pressure (kPa)	3000	7698	7698	7198	7698
15	Molar Flow (kgmole/h)	4000	2.287e+004	1.307e+005	1.185e+005	1.307e+005
16	Mass Flow (tonne/d)	1731	6176	3.610e+004	3.610e+004	3.610e+004
17	Std Ideal Liq Vol Flow (m3/h)	72.28	726.6	4292	3960	4292
18	Heat Flow (kJ/h)	-1.147e+009	-1.005e+009	-6.771e+009	-6.592e+009	-5.936e+009
19	Molar Enthalpy (kJ/kgmole)	-2.867e+005	-4.396e+004	-5.182e+004	-5.564e+004	-4.542e+004
20	Comp Mole Frac (Methanol)	0.0000	0.0000	0.0045	0.0564	0.0045
21	Comp Mole Frac (CO)	0.0000	0.2876	0.2342	0.2103	0.2342
22	Comp Mole Frac (CO2)	0.0005	0.0374	0.0585	0.0611	0.0585
23	Comp Mole Frac (H2O)	0.9995	0.0009	0.0003	0.0038	0.0003
24	Comp Mole Frac (Methane)	0.0000	0.0087	0.0405	0.0446	0.0405
25	Comp Mole Frac (Hydrogen)	0.0000	0.6634	0.6527	0.6135	0.6527
26	Comp Mole Frac (Ethane)	0.0000	0.0000	0.0000	0.0000	0.0000
27	Comp Mole Frac (Propane)	0.0000	0.0000	0.0000	0.0000	0.0000
28	Comp Mole Frac (n-Butane)	0.0000	0.0000	0.0000	0.0000	0.0000
29	Comp Mole Frac (Nitrogen)	0.0000	0.0019	0.0094	0.0103	0.0094
30	Comp Mole Frac (Oxygen)	0.0000	0.0000	0.0000	0.0000	0.0000
31						
32						
33	Honeywell International Inc.		UniSim Design (R380 Build 14027)		Page 4 of 20	

1	 Norwegian University of Science and Trondheim Norway		Case Name: E:\Thesis\Methanol process simulation.usc			
2			Unit Set: optimizer			
3			Date/Time: Tuesday Jun 8 2010, 23:38:16			
4						
5						
6	<b>Workbook: Case (Main) (continued)</b>					
7						
8						
9	<b>Streams (continued)</b>				Fluid Pkg: All	
10						
11	Name	15	Crude_methanol	17	Purge_gas	Recycle_gas
12	Vapour Fraction	1.0000	0.0000	1.0000	1.0000	1.0000
13	Temperature (C)	40.00 *	40.00	40.00	40.00	47.93 *
14	Pressure (kPa)	7198	7198	7198	7198	7698 *
15	Molar Flow (kgmole/h)	1.117e+005	6755	1.078e+005	3910	1.078e+005 *
16	Mass Flow (tonne/d)	3.102e+004	5088	2.993e+004	1086	2.993e+004
17	Std Ideal Liq Vol Flow (m3/h)	3695	264.9	3565	129.3	3565
18	Heat Flow (kJ/h)	-6.003e+009	-1.668e+009	-5.793e+009	-2.101e+008	-5.766e+009
19	Molar Enthalpy (kJ/kgmole)	-5.373e+004	-2.469e+005	-5.373e+004	-5.373e+004	-5.348e+004
20	Comp Mole Frac (Methanol)	0.0054	0.8997	0.0054	0.0054	0.0054 *
21	Comp Mole Frac (CO)	0.2228	0.0026	0.2228	0.2228	0.2228 *
22	Comp Mole Frac (CO2)	0.0630	0.0292	0.0630	0.0630	0.0630 *
23	Comp Mole Frac (H2O)	0.0002	0.0638	0.0002	0.0002	0.0002 *
24	Comp Mole Frac (Methane)	0.0472	0.0022	0.0472	0.0472	0.0472 *
25	Comp Mole Frac (Hydrogen)	0.6504	0.0024	0.6504	0.6504	0.6504 *
26	Comp Mole Frac (Ethane)	0.0000	0.0000	0.0000	0.0000	0.0000 *
27	Comp Mole Frac (Propane)	0.0000	0.0000	0.0000	0.0000	0.0000 *
28	Comp Mole Frac (n-Butane)	0.0000	0.0000	0.0000	0.0000	0.0000 *
29	Comp Mole Frac (Nitrogen)	0.0110	0.0001	0.0110	0.0110	0.0110 *
30	Comp Mole Frac (Oxygen)	0.0000	0.0000	0.0000	0.0000	0.0000 *
31						
32						
33	Honeywell International Inc.		UniSim Design (R380 Build 14027)		Page 5 of 20	



1		Case Name: E:\Thesis\Methanol process simulation.usc
2		Unit Set: optimizer
3		Date/Time: Tuesday Jun 8 2010, 23:38:16
4		
5		

## Workbook: Case (Main) (continued)

Streams (continued)						Fluid Pkg:	All
Name	Off_gas	20	Recovered_H2	Methanol	Dummy		
Vapour Fraction	0.9999	1.0000	1.0000	1.0000	0.0000		
Temperature (C)	41.61	30.00 *	30.00 *	138.6	138.6		
Pressure (kPa)	7198	7198	7198 *	1000	1000		
Molar Flow (kgmole/h)	3478	432.4	432.4 *	6076	6.506e-005		
Mass Flow (tonne/d)	1065	20.92	20.92	4671	5.000e-005		
Std Ideal Liq Vol Flow (m3/h)	116.8	12.48	12.48	244.6	2.618e-006		
Heat Flow (kJ/h)	-2.102e+008	1.008e+005	1.008e+005	-1.198e+009	-14.84		
Molar Enthalpy (kJ/kgmole)	-6.044e+004	233.1	233.1	-1.971e+005	-2.281e+005		
Comp Mole Frac (Methanol)	0.0061	0.0000	0.0000 *	0.9993	0.9988		
Comp Mole Frac (CO)	0.2505	0.0000	0.0000 *	0.0000	0.0000		
Comp Mole Frac (CO2)	0.0708	0.0000	0.0000 *	0.0000	0.0000		
Comp Mole Frac (H2O)	0.0002	0.0000	0.0000 *	0.0007	0.0012		
Comp Mole Frac (Methane)	0.0531	0.0000	0.0000 *	0.0000	0.0000		
Comp Mole Frac (Hydrogen)	0.6069	1.0000	1.0000 *	0.0000	0.0000		
Comp Mole Frac (Ethane)	0.0000	0.0000	0.0000 *	0.0000	0.0000		
Comp Mole Frac (Propane)	0.0000	0.0000	0.0000 *	0.0000	0.0000		
Comp Mole Frac (n-Butane)	0.0000	0.0000	0.0000 *	0.0000	0.0000		
Comp Mole Frac (Nitrogen)	0.0123	0.0000	0.0000 *	0.0000	0.0000		
Comp Mole Frac (Oxygen)	0.0000	0.0000	0.0000 *	0.0000	0.0000		

1	 Norwegian University of Science and Trondheim Norway	Case Name: E:\Thesis\Methanol process simulation.usc
2		Unit Set: optimizer
3		Date/Time: Tuesday Jun 8 2010, 23:38:16
4		
5		

## Workbook: Case (Main) (continued)

Streams (continued)						Fluid Pkg:	All
Name	Waste_water	H2O	8	11	16		
Vapour Fraction	0.0000	0.0000	0.0000	0.5958	0.5958		
Temperature (C)	178.6	30.00 *	30.25	252.4	252.4		
Pressure (kPa)	1015	100.0 *	4000 *	4000	4000		
Molar Flow (kgmole/h)	430.5	2.115e+004 *	2.115e+004	2.115e+004	1.714e+004		
Mass Flow (tonne/d)	187.5	9143	9143	9143	7410		
Std Ideal Liq Vol Flow (m3/h)	7.859	381.7	381.7	381.7	309.4		
Heat Flow (kJ/h)	-1.176e+008	-6.047e+009	-6.045e+009	-5.253e+009	-4.258e+009		
Molar Enthalpy (kJ/kgmole)	-2.733e+005	-2.860e+005	-2.859e+005	-2.484e+005	-2.484e+005		
Comp Mole Frac (Methanol)	0.0093	0.0000 *	0.0000	0.0000	0.0000		
Comp Mole Frac (CO)	0.0000	0.0000 *	0.0000	0.0000	0.0000		
Comp Mole Frac (CO2)	0.0000	0.0000 *	0.0000	0.0000	0.0000		
Comp Mole Frac (H2O)	0.9907	1.0000 *	1.0000	1.0000	1.0000		
Comp Mole Frac (Methane)	0.0000	0.0000 *	0.0000	0.0000	0.0000		
Comp Mole Frac (Hydrogen)	0.0000	0.0000 *	0.0000	0.0000	0.0000		
Comp Mole Frac (Ethane)	0.0000	0.0000 *	0.0000	0.0000	0.0000		
Comp Mole Frac (Propane)	0.0000	0.0000 *	0.0000	0.0000	0.0000		
Comp Mole Frac (n-Butane)	0.0000	0.0000 *	0.0000	0.0000	0.0000		
Comp Mole Frac (Nitrogen)	0.0000	0.0000 *	0.0000	0.0000	0.0000		
Comp Mole Frac (Oxygen)	0.0000	0.0000 *	0.0000	0.0000	0.0000		



1	 Norwegian University of Science and Trondheim Norway		Case Name: E:\Thesis\Methanol process simulation.usc			
2			Unit Set: optimizer			
3			Date/Time: Tuesday Jun 8 2010, 23:38:16			
4						
5						
6	<b>Workbook: Case (Main) (continued)</b>					
7						
8						
9	<b>Streams (continued)</b>			Fluid Pkg: All		
10						
11	Name	18	19	Excess steam	10	22
12	Vapour Fraction	1.0000	0.9291	0.5958	1.0000	0.9979
13	Temperature (C)	400.0 *	46.06	252.4	200.0 *	44.20
14	Pressure (kPa)	4000	10.00 *	4000	3000	7198
15	Molar Flow (kgmole/h)	1.714e+004	1.714e+004	4008	2.644e+004	2607
16	Mass Flow (tonne/d)	7410	7410	1733	7886	478.9
17	Std Ideal Liq Vol Flow (m3/h)	309.4	309.4	72.34	786.4	86.31
18	Heat Flow (kJ/h)	-3.937e+009	-4.185e+009	-9.956e+008	-1.915e+009	-1.140e+008
19	Molar Enthalpy (kJ/kgmole)	-2.297e+005	-2.442e+005	-2.484e+005	-7.243e+004	-4.374e+004
20	Comp Mole Frac (Methanol)	0.0000	0.0000	0.0000	0.0000	0.0082
21	Comp Mole Frac (CO)	0.0000	0.0000	0.0000	0.2488	0.0000
22	Comp Mole Frac (CO2)	0.0000	0.0000	0.0000	0.0325	0.0945
23	Comp Mole Frac (H2O)	1.0000	1.0000	1.0000	0.1520	0.0002
24	Comp Mole Frac (Methane)	0.0000	0.0000	0.0000	0.0075	0.0708
25	Comp Mole Frac (Hydrogen)	0.0000	0.0000	0.0000	0.5575	0.8098
26	Comp Mole Frac (Ethane)	0.0000	0.0000	0.0000	0.0000	0.0000
27	Comp Mole Frac (Propane)	0.0000	0.0000	0.0000	0.0000	0.0000
28	Comp Mole Frac (n-Butane)	0.0000	0.0000	0.0000	0.0000	0.0000
29	Comp Mole Frac (Nitrogen)	0.0000	0.0000	0.0000	0.0017	0.0164
30	Comp Mole Frac (Oxygen)	0.0000	0.0000	0.0000	0.0000	0.0000
31						
32						
33	Honeywell International Inc.		UniSim Design (R380 Build 14027)		Page 8 of 20	

1		Norwegian University of Science and Trondheim Norway	Case Name: E:\Thesis\Methanol process simulation.usc
2			Unit Set: optimizer
3			Date/Time: Tuesday Jun 8 2010, 23:38:16
4			
5			

## Workbook: Case (Main) (continued)

Streams (continued)						Fluid Pkg:	All
Name	23	24	25	26	27		
Vapour Fraction	1.0000	0.9674	1.0000	0.9280	1.0000		
Temperature (C)	44.20	55.75	55.75	63.41	63.41		
Pressure (kPa)	7198	7198	7198	7198	7198		
Molar Flow (kgmole/h)	871.3	495.7	2111	311.1	184.6		
Mass Flow (tonne/d)	585.8	376.7	102.1	305.7	71.09		
Std Ideal Liq Vol Flow (m3/h)	30.53	25.39	60.92	15.49	9.893		
Heat Flow (kJ/h)	-9.619e+007	-1.161e+008	2.056e+006	-1.023e+008	-1.374e+007		
Molar Enthalpy (kJ/kgmole)	-1.104e+005	-2.341e+005	973.8	-3.289e+005	-7.442e+004		
Comp Mole Frac (Methanol)	0.0000	0.0429	0.0000	0.0683	0.0000		
Comp Mole Frac (CO)	1.0000	0.0000	0.0000	0.0000	0.0000		
Comp Mole Frac (CO2)	0.0000	0.4970	0.0000	0.7919	0.0000		
Comp Mole Frac (H2O)	0.0000	0.0013	0.0000	0.0020	0.0000		
Comp Mole Frac (Methane)	0.0000	0.3724	0.0000	0.0000	1.0000		
Comp Mole Frac (Hydrogen)	0.0000	0.0000	1.0000	0.0000	0.0000		
Comp Mole Frac (Ethane)	0.0000	0.0000	0.0000	0.0000	0.0000		
Comp Mole Frac (Propane)	0.0000	0.0000	0.0000	0.0000	0.0000		
Comp Mole Frac (n-Butane)	0.0000	0.0000	0.0000	0.0000	0.0000		
Comp Mole Frac (Nitrogen)	0.0000	0.0864	0.0000	0.1377	0.0000		
Comp Mole Frac (Oxygen)	0.0000	0.0000	0.0000	0.0000	0.0000		



Norwegian University of Science and  
Trondheim  
Norway

Case Name: E:\Thesis\Methanol process simulation.usc

Unit Set: optimizer

Date/Time: Tuesday Jun 8 2010, 23:38:16

## Workbook: Case (Main) (continued)

### Streams (continued)

Fluid Pkg:

All

Name	extra N.G	1	excess	steam	32
Vapour Fraction	1.0000	1.0000	0.5958	0.5958	1.0000
Temperature (C)	50.00 *	47.93	252.4	252.4	493.0
Pressure (kPa)	7000 *	7698	4000	4000	3000
Molar Flow (kgmole/h)	147.2	1.078e+005	-258.0	4266 *	1.157e+004
Mass Flow (tonne/d)	59.52	2.993e+004	-111.5	1844	4795
Std Ideal Liq Vol Flow (m3/h)	8.061	3565	-4.657	77.00	476.7
Heat Flow (kJ/h)	-1.108e+007	-5.767e+009	6.409e+007	-1.060e+009	-1.339e+009
Molar Enthalpy (kJ/kgmole)	-7.524e+004	-5.348e+004	-2.484e+005	-2.484e+005	-1.158e+005
Comp Mole Frac (Methanol)	0.0000 *	0.0054	0.0000	0.0000	0.0000
Comp Mole Frac (CO)	0.0000 *	0.2228	0.0000	0.0000	0.0000
Comp Mole Frac (CO2)	0.0000 *	0.0630	0.0000	0.0000	0.0000
Comp Mole Frac (H2O)	0.0000 *	0.0002	1.0000	1.0000	0.3688
Comp Mole Frac (Methane)	0.9550 *	0.0472	0.0000	0.0000	0.6028
Comp Mole Frac (Hydrogen)	0.0000 *	0.6504	0.0000	0.0000	0.0000
Comp Mole Frac (Ethane)	0.0300 *	0.0000	0.0000	0.0000	0.0189
Comp Mole Frac (Propane)	0.0050 *	0.0000	0.0000	0.0000	0.0032
Comp Mole Frac (n-Butane)	0.0040 *	0.0000	0.0000	0.0000	0.0025
Comp Mole Frac (Nitrogen)	0.0060 *	0.0110	0.0000	0.0000	0.0038
Comp Mole Frac (Oxygen)	0.0000 *	0.0000	0.0000	0.0000	0.0000

1	 Norwegian University of Science and Trondheim Norway		Case Name: E:\Thesis\Methanol process simulation.usc			
2			Unit Set: optimizer			
3			Date/Time: Tuesday Jun 8 2010, 23:38:16			
4						
5						
6	<b>Workbook: Case (Main) (continued)</b>					
7						
8						
9	<b>Streams (continued)</b>				Fluid Pkg: All	
10						
11	Name	CW	31	MP steam	36	Ovhd
12	Vapour Fraction	0.0000	0.0000	1.0000	0.0000	1.0000
13	Temperature (C)	30.00 *	30.25	290.1	290.1	18.00
14	Pressure (kPa)	101.0 *	3965 *	3965	3965	1050
15	Molar Flow (kgmole/h)	1.271e+004 *	1.271e+004	1.271e+004	0.0000	249.0
16	Mass Flow (tonne/d)	5496	5496	5496	0.0000	229.3
17	Std Ideal Liq Vol Flow (m3/h)	229.5	229.5	229.5	0.0000	12.52
18	Heat Flow (kJ/h)	-3.635e+009	-3.634e+009	-2.977e+009	0.0000	-8.147e+007
19	Molar Enthalpy (kJ/kgmole)	-2.860e+005	-2.859e+005	-2.342e+005	-2.630e+005	-3.272e+005
20	Comp Mole Frac (Methanol)	0.0000 *	0.0000	0.0000	0.0000	0.0097
21	Comp Mole Frac (CO)	0.0000 *	0.0000	0.0000	0.0000	0.0703
22	Comp Mole Frac (CO2)	0.0000 *	0.0000	0.0000	0.0000	0.7935
23	Comp Mole Frac (H2O)	1.0000 *	1.0000	1.0000	1.0000	0.0000
24	Comp Mole Frac (Methane)	0.0000 *	0.0000	0.0000	0.0000	0.0589
25	Comp Mole Frac (Hydrogen)	0.0000 *	0.0000	0.0000	0.0000	0.0638
26	Comp Mole Frac (Ethane)	0.0000 *	0.0000	0.0000	0.0000	0.0000
27	Comp Mole Frac (Propane)	0.0000 *	0.0000	0.0000	0.0000	0.0000
28	Comp Mole Frac (n-Butane)	0.0000 *	0.0000	0.0000	0.0000	0.0000
29	Comp Mole Frac (Nitrogen)	0.0000 *	0.0000	0.0000	0.0000	0.0038
30	Comp Mole Frac (Oxygen)	0.0000 *	0.0000	0.0000	0.0000	0.0000
31						
32						
33	Honeywell International Inc.		UniSim Design (R380 Build 14027)		Page 11 of 20	

1	 Norwegian University of Science and Trondheim Norway	Case Name: E:\Thesis\Methanol process simulation.usc
2		Unit Set: optimizer
3		Date/Time: Tuesday Jun 8 2010, 23:38:16
4		
5		

## Workbook: Case (Main) (continued)

Streams (continued)						Fluid Pkg:	All
Name	Bottoms	2	21	Q-101	Q-102		
Vapour Fraction	0.0000	1.0000	1.0000	---	---		
Temperature (C)	143.7	650.0 *	20.20	---	---		
Pressure (kPa)	1100	3000	3000	---	---		
Molar Flow (kgmole/h)	6506	1.619e+004	2.287e+004	---	---		
Mass Flow (tonne/d)	4858	7886	6176	---	---		
Std Ideal Liq Vol Flow (m3/h)	252.4	613.3	726.6	---	---		
Heat Flow (kJ/h)	-1.500e+009	-1.123e+009	-1.088e+009	1.026e+007	1.838e+008		
Molar Enthalpy (kJ/kgmole)	-2.305e+005	-6.940e+004	-4.758e+004	---	---		
Comp Mole Frac (Methanol)	0.9338	0.0000	0.0000	---	---		
Comp Mole Frac (CO)	0.0000	0.0005	0.2876	---	---		
Comp Mole Frac (CO2)	0.0000	0.0180	0.0374	---	---		
Comp Mole Frac (H2O)	0.0662	0.2271	0.0009	---	---		
Comp Mole Frac (Methane)	0.0000	0.4533	0.0087	---	---		
Comp Mole Frac (Hydrogen)	0.0000	0.0498	0.6634	---	---		
Comp Mole Frac (Ethane)	0.0000	0.0000	0.0000	---	---		
Comp Mole Frac (Propane)	0.0000	0.0000	0.0000	---	---		
Comp Mole Frac (n-Butane)	0.0000	0.0000	0.0000	---	---		
Comp Mole Frac (Nitrogen)	0.0000	0.0027	0.0019	---	---		
Comp Mole Frac (Oxygen)	0.0000	0.2486	0.0000	---	---		



1	 Norwegian University of Science and Trondheim Norway	Case Name: E:\Thesis\Methanol process simulation.usc				
2		Unit Set: optimizer				
3		Date/Time: Tuesday Jun 8 2010, 23:38:16				
4						
5						
6	<b>Workbook: Case (Main) (continued)</b>					
7						
8						
9	<b>Streams (continued)</b>					Fluid Pkg: All
10						
11	Name	Q-104	Q-105	Q-106	Q-107	Q-108
12	Vapour Fraction	---	---	---	---	---
13	Temperature (C)	---	---	---	---	---
14	Pressure (kPa)	---	---	---	---	---
15	Molar Flow (kgmole/h)	---	---	---	---	---
16	Mass Flow (tonne/d)	---	---	---	---	---
17	Std Ideal Liq Vol Flow (m3/h)	---	---	---	---	---
18	Heat Flow (kJ/h)	9.663e+007	0.0000 *	0.0000 *	0.0000 *	2.434e+007
19	Molar Enthalpy (kJ/kgmole)	---	---	---	---	---
20	Comp Mole Frac (Methanol)	---	---	---	---	---
21	Comp Mole Frac (CO)	---	---	---	---	---
22	Comp Mole Frac (CO2)	---	---	---	---	---
23	Comp Mole Frac (H2O)	---	---	---	---	---
24	Comp Mole Frac (Methane)	---	---	---	---	---
25	Comp Mole Frac (Hydrogen)	---	---	---	---	---
26	Comp Mole Frac (Ethane)	---	---	---	---	---
27	Comp Mole Frac (Propane)	---	---	---	---	---
28	Comp Mole Frac (n-Butane)	---	---	---	---	---
29	Comp Mole Frac (Nitrogen)	---	---	---	---	---
30	Comp Mole Frac (Oxygen)	---	---	---	---	---
31						
32						
33	Honeywell International Inc.		UniSim Design (R380 Build 14027)		Page 13 of 20	

1		Norwegian University of Science and Trondheim Norway	Case Name: E:\Thesis\Methanol process simulation.usc				
2			Unit Set: optimizer				
3			Date/Time: Tuesday Jun 8 2010, 23:38:16				
4			<b>Workbook: Case (Main) (continued)</b>				
5			<b>Streams (continued)</b>				
6					Fluid Pkg: All		
7							
8							
9							
10							
11	Name	Q-109	Q-110	Q-111	Q-112	Q-113	
12	Vapour Fraction	---	---	---	---	---	
13	Temperature (C)	---	---	---	---	---	
14	Pressure (kPa)	---	---	---	---	---	
15	Molar Flow (kgmole/h)	---	---	---	---	---	
16	Mass Flow (tonne/d)	---	---	---	---	---	
17	Std Ideal Liq Vol Flow (m3/h)	---	---	---	---	---	
18	Heat Flow (kJ/h)	1.946e+008	3.205e+008	8.272e+007	6.564e+008	8.355e+008	
19	Molar Enthalpy (kJ/kgmole)	---	---	---	---	---	
20	Comp Mole Frac (Methanol)	---	---	---	---	---	
21	Comp Mole Frac (CO)	---	---	---	---	---	
22	Comp Mole Frac (CO2)	---	---	---	---	---	
23	Comp Mole Frac (H2O)	---	---	---	---	---	
24	Comp Mole Frac (Methane)	---	---	---	---	---	
25	Comp Mole Frac (Hydrogen)	---	---	---	---	---	
26	Comp Mole Frac (Ethane)	---	---	---	---	---	
27	Comp Mole Frac (Propane)	---	---	---	---	---	
28	Comp Mole Frac (n-Butane)	---	---	---	---	---	
29	Comp Mole Frac (Nitrogen)	---	---	---	---	---	
30	Comp Mole Frac (Oxygen)	---	---	---	---	---	
31							
32							
33	Honeywell International Inc.	UniSim Design (R380 Build 14027)			Page 14 of 20		

1	 Norwegian University of Science and Trondheim Norway	Case Name: E:\Thesis\Methanol process simulation.usc				
2		Unit Set: optimizer				
3		Date/Time: Tuesday Jun 8 2010, 23:38:16				
4						
5						
6	<b>Workbook: Case (Main) (continued)</b>					
7						
8						
9	<b>Streams (continued)</b>				Fluid Pkg:	All
10						
11	Name	Q-114	Condenser_duty	Reboiler_duty	Q-115	Q-116
12	Vapour Fraction	---	---	---	---	---
13	Temperature (C)	---	---	---	---	---
14	Pressure (kPa)	---	---	---	---	---
15	Molar Flow (kgmole/h)	---	---	---	---	---
16	Mass Flow (tonne/d)	---	---	---	---	---
17	Std Ideal Liq Vol Flow (m3/h)	---	---	---	---	---
18	Heat Flow (kJ/h)	1.078e+009	5.534e+008	7.381e+008	1.974e+006	3.207e+008
19	Molar Enthalpy (kJ/kgmole)	---	---	---	---	---
20	Comp Mole Frac (Methanol)	---	---	---	---	---
21	Comp Mole Frac (CO)	---	---	---	---	---
22	Comp Mole Frac (CO2)	---	---	---	---	---
23	Comp Mole Frac (H2O)	---	---	---	---	---
24	Comp Mole Frac (Methane)	---	---	---	---	---
25	Comp Mole Frac (Hydrogen)	---	---	---	---	---
26	Comp Mole Frac (Ethane)	---	---	---	---	---
27	Comp Mole Frac (Propane)	---	---	---	---	---
28	Comp Mole Frac (n-Butane)	---	---	---	---	---
29	Comp Mole Frac (Nitrogen)	---	---	---	---	---
30	Comp Mole Frac (Oxygen)	---	---	---	---	---
31						
32						
33	Honeywell International Inc.	UniSim Design (R380 Build 14027)			Page 15 of 20	



1		Norwegian University of Science and Trondheim Norway	Case Name: E:\Thesis\Methanol process simulation.usc
2			Unit Set: optimizer
3			Date/Time: Tuesday Jun 8 2010, 23:38:16
4			
5			

## Workbook: Case (Main) (continued)

Streams (continued)						Fluid Pkg:	All
Name	Q-117	Q-100	Q-119	Q_cond	Q_reb		
Vapour Fraction	---	---	---	---	---		---
Temperature (C)	---	---	---	---	---		---
Pressure (kPa)	---	---	---	---	---		---
Molar Flow (kgmole/h)	---	---	---	---	---		---
Mass Flow (tonne/d)	---	---	---	---	---		---
Std Ideal Liq Vol Flow (m3/h)	---	---	---	---	---		---
Heat Flow (kJ/h)	2.481e+008	2.636e+007	1.175e+006	3.313e+007	1.194e+008		
Molar Enthalpy (kJ/kgmole)	---	---	---	---	---		---
Comp Mole Frac (Methanol)	---	---	---	---	---		---
Comp Mole Frac (CO)	---	---	---	---	---		---
Comp Mole Frac (CO2)	---	---	---	---	---		---
Comp Mole Frac (H2O)	---	---	---	---	---		---
Comp Mole Frac (Methane)	---	---	---	---	---		---
Comp Mole Frac (Hydrogen)	---	---	---	---	---		---
Comp Mole Frac (Ethane)	---	---	---	---	---		---
Comp Mole Frac (Propane)	---	---	---	---	---		---
Comp Mole Frac (n-Butane)	---	---	---	---	---		---
Comp Mole Frac (Nitrogen)	---	---	---	---	---		---
Comp Mole Frac (Oxygen)	---	---	---	---	---		---

### C. Selection of control variables

This part of the appendix outlines how to compute the linear gain matrix  $G$ , the Hessian  $J_{uu}$  of unconstrained inputs, the objective function  $J_{ud}$  in the presence of disturbances, optimal variation for candidate control variables  $span(c_i)$  and the disturbance matrix  $G_d$ .

$G$  and  $J_{uu}$  are calculated with respect to the optimal nominal point, assuming zero disturbances. The matrix is calculated by using the usual approximation:

$$\frac{\partial c_i(u)}{\partial u_j} = \lim_{h \rightarrow 0} \frac{c(u + e_j h) - c(u)}{h_j}$$

Where  $i = 1 \dots n_c$  is the index of the candidate control variables,  $j = 1 \dots n_u$  is the index set of unconstrained inputs,  $h$  is the vector of increments for each input  $u_j$ , and  $e_j = [000 \dots 1 \dots 0]$  is the zero vector except for the  $j$ -element which is 1.

In UniSim<sup>TM</sup>, the assumption made was that  $c(u)$  is the nominal point of the unconstrained input and  $c(u + e_j h)$  was evaluated by adding a step of magnitude  $e_j h$  to the vector  $u$  for each input  $j$  and then the resulting vectors was then taken excel which numerically calculates the term  $G_{ij} = \frac{\partial c_i(u)}{\partial u_j}$ .

The Hessian  $J_{uu}$  is also evaluated in a similar manner and the approximation used was:

$$\frac{\partial^2 J(u)}{\partial u_j^2} \Big|_i = \lim_{h \rightarrow 0} \frac{J(u + E_{ii}h + E_{jj}h) - J(u + E_{ii}h) - J(u + E_{jj}h) + J(u)}{[hh^T]_{ij}}$$

Where  $E_{ij}$  is the zero matrix except for the  $ij$ -element which is 1. Since there were only two unconstrained inputs, the matrix was calculated as;

$$J_{uu} = \begin{bmatrix} \frac{\partial^2 J(u)}{\partial u_1^2} & \frac{\partial}{\partial u_1} \frac{\partial J(u)}{\partial u_2} \\ \frac{\partial}{\partial u_2} \frac{\partial J(u)}{\partial u_1} & \frac{\partial^2 J(u)}{\partial u_2^2} \end{bmatrix}$$

Where  $u_1$  and  $u_2$  are pressure and the split ratio respectively.

$J_{ud}$  is calculated using the same approximation as the Hessian; the only difference is that the disturbances are included in this matrix. The matrix is as follows;

$$J_{ud} = \begin{bmatrix} \frac{\partial}{\partial u_1} \frac{\partial J}{\partial d_1} & \frac{\partial}{\partial u_1} \frac{\partial J}{\partial d_2} & \frac{\partial}{\partial u_1} \frac{\partial J}{\partial d_3} & \frac{\partial}{\partial u_1} \frac{\partial J}{\partial d_4} \\ \frac{\partial}{\partial u_2} \frac{\partial J}{\partial d_1} & \frac{\partial}{\partial u_2} \frac{\partial J}{\partial d_2} & \frac{\partial}{\partial u_2} \frac{\partial J}{\partial d_3} & \frac{\partial}{\partial u_2} \frac{\partial J}{\partial d_4} \end{bmatrix}$$

Where  $d_1$ ,  $d_2$ ,  $d_3$  and  $d_4$  are the disturbances resulting from the natural gas flowrate, composition, inlet temperature of the ATR and outlet temperature of the methanol reactor respectively considered for this analysis.

The optimal variation for the candidate variables ( $span(c_i)$ ) was used for the scaling of the linear matrix  $G$  obtained by linearizing the nonlinear model of the process. For each of the candidate controlled variable  $c_i$ , the optimal maximum variation  $\Delta c_{i,opt}(d)$  due to the variation in disturbances. The optimal parameters (inputs and outputs) from the nonlinear model for different conditions (disturbances and operating points). This gives rise to each candidate control variable  $c_i$  having different sets of values for  $\Delta c_{i,opt}(d)$ . From this we can apply the criteria below to choose the one that has maximum effect.

$$\Delta c_{i,opt}(d) = \max_{j \in D} (|c_{i,opt}^j - c_{i,opt}^{nom}|)$$

Where  $D$  is the set of disturbances,  $c_{i,opt}^j$  is the optimal value of  $c_i$  due to disturbance  $j$  and  $c_{i,opt}^{nom}$  is the nominal optimal value of  $c_i$ . Implementation error  $n_i$  (sum of measurement error and control error) for each candidate control variable  $c_i$  was also obtained. The scaling of the variables with the sum of the magnitudes of  $\Delta c_{i,opt}(d)$  and implementation error  $n_i$  makes them similar. The sum is called the span of the variable which is given as;

$$span(c_i) = \Delta c_{i,opt}(d) + n_i$$

The scaling matrix  $S_l$  can then be computed as  $S_1 = diag \left\{ \frac{1}{span(c_i)} \right\}$ .

The worst-case loss is given by:

$$\max_{\|f'\|_2 \leq 1} L = \bar{\sigma}(\mathbf{M})^2 / 2$$

where

$$\mathbf{M} = (\mathbf{M}_d \mathbf{M}_n)$$

$$\mathbf{M}_d = J_{uu}^{-\frac{1}{2}} (J_{uu}^{-1} J_{ud} - G^{-1} G_d) W_d$$

$$\mathbf{M}_n = J_{uu}^{1/2} G^{-1} W_n$$

$W_d$  represents the expected magnitude of the individual disturbances and  $W_n$  the magnitude of the implementation error.