

Topics in Nonlinear Control

Output Feedback Stabilization
and
Control of Positive Systems

Lars Struen Imsland

A DISSERTATION SUBMITTED IN PARTIAL FULFILLMENT
OF THE REQUIREMENTS FOR THE DEGREE OF

DOKTOR INGENIØR



Department of Engineering Cybernetics
Norwegian University of Science and Technology

2002

Norwegian University of Science and Technology
Department of Engineering Cybernetics
N-7491 Trondheim
Norway

Doktor ingeniøravhandling 2002:112
ITK Rapport 2002-6-W

ISBN 82-471-5504-4
ISSN 0809-103X

Summary

The contributions of this thesis are in the area of control of systems with nonlinear dynamics. The thesis is divided into three parts. The two first parts are similar in the sense that they both consider output feedback of rather general classes of nonlinear systems, and both approaches are based on mathematical programming (although in quite different ways). The third part contains a state feedback approach for a specific system class, and is more application oriented.

The first part treats control of systems described by nonlinear difference equations, possibly with uncertain terms. The system dynamics are represented by piecewise affine difference inclusions, and for this system class, piecewise affine controller structures are suggested. Controller synthesis inequalities for such controller structures are given in the form of Bilinear Matrix Inequalities (BMIs). A solver for the BMIs is developed. The main contribution is to the output feedback case, where an observer-based controller structure is proposed. The theory is exemplified through two examples.

In the second part the output feedback problem is examined in the setting of Nonlinear Model Predictive Control (NMPC). The state space formulation of NMPC is inherently a state feedback approach, since the state is needed as initial condition for the prediction in the controller. Consequently, for output feedback it is natural to use observers to obtain estimates of the state. A high gain observer is applied for this purpose. It is shown that for several existing NMPC schemes, the state feedback stability properties “semiglobally” hold in the output feedback case. The theory is illuminated with a simple example.

Finally, a state feedback controller for a class of positive systems is proposed. Convergence of the state to a certain subset of the first orthant, corresponding to a constant “total mass” (interpreting states as masses) is obtained. Conditions are given under which convergence to this set implies asymptotic stability of an equilibrium. Simple examples illustrate some properties of the controller. Furthermore, the control strategy is applied to the stabilization of a gas-lifted oil well, and simulations on a rigorous multi-phase

SUMMARY

dynamic simulator of such a well demonstrate the controller performance.

Preface

This thesis presents the main results of my research as a doctoral student at the department of Engineering Cybernetics, under the supervision of Professor Bjarne A. Foss.

I thank Bjarne for giving me the opportunity to do the research resulting in this thesis, and for providing me with good and stimulating working conditions for doing research. He has always been optimistic, giving me inspiration and feedback, and taken good care of the practicalities.

When I started doing research, I worked together with one of Bjarne's former students, Olav Slupphaug. The first part of this thesis can be regarded as a continuation of Olav's thesis work, and is partly done in cooperation with Olav. I enjoyed doing research, sharing an office and traveling with Olav. One of the more important things he taught me, is that the devil is in the details.

In August 2000, I left for Stuttgart to visit Frank Allgöwer's institute. I had a very nice stay there, where the foundations for the work in the second part of the thesis were laid. Frank's group, and in particular Rolf Findeisen, received me with open arms. Frank provided me with good working conditions, and even though he was immensely busy, he had time to give me valuable feedback and advise. The time in Stuttgart initiated a very fruitful research cooperation with Rolf in particular, but I should also mention Eric Bullinger. The research reported in Chapters 4 and 5 should be regarded joint work with Rolf, continued by email and when Rolf visited Trondheim in the winter 2002. Rolf is very hard working, and has taught me that results can always be presented better. He has also been very helpful in proofreading large parts of the thesis.

After I returned from Stuttgart, Bjarne introduced me to the problem of stabilization of gas-lifted oil wells. I did some initial work on this together with Gisle Otto Eikrem and Hu Bin, which inspired the work reported in the third part of the thesis. The OLGA simulations in Chapter 6 were done in cooperation with Gisle. The presentation of Chapter 6 has benefited from discussions with Roger Skjetne, who also proof-read other parts of the thesis.

PREFACE

I also want to acknowledge Henrik Holm and Leif Warland for shearing latex and emacs insights with me.

I thank Ann Irene for her love and support, and for trying to draw my attention to other things than work. And my parents, who always were there for me.

Contents

Summary	i
Preface	iii
Contents	v
1 Introduction	1
1.1 Some qualitative concepts and tools	2
1.2 Finding a Lyapunov function	7
1.3 Output feedback	9
1.4 Contributions	10
1.5 Thesis outline	11
I Piecewise Affine Robust Output Feedback	13
<hr/>	
2 A Synthesis Result for Piecewise Affine Difference Inclusions	15
2.1 Introduction	15
2.2 Model class	16
2.2.1 Piecewise affine difference inclusions	16
2.2.2 Set approximations	17
2.3 Affine stability and synthesis inequalities	19
2.3.1 Stability definition	19
2.3.2 Synthesis inequalities	20
2.4 Solving the bilinear matrix inequalities	25
2.5 Discussion and some concluding remarks	27

3	Robust Output Feedback Using Piecewise Affine Observers and Controllers	29
3.1	Introduction	29
3.2	System and observer models	31
3.2.1	System class and piecewise affine encapsulation	31
3.2.2	Observer class and piecewise affine encapsulation or representation	33
3.3	Output feedback controller synthesis	34
3.3.1	Feedback and observer injection structure	35
3.3.2	Closed-loop dynamics	35
3.3.3	The subsets of the state-space with the same observer and feedback	36
3.3.4	Set approximations	37
3.3.5	Combined synthesis based on quadratic stability	38
3.3.6	Input constraints	40
3.3.7	Reducing conservatism	41
3.4	Separate synthesis of observer and state feedback	42
3.4.1	Local results	42
3.4.2	Regional results	44
3.5	Examples	47
3.5.1	An unstable nonlinear system	47
3.5.2	Wheel slip control	54
3.6	Discussion and concluding remarks	63
II	Output Feedback Nonlinear Predictive Control	67
4	Output feedback Nonlinear Model Predictive Control - Stability, Performance and Robustness in the Instantaneous Case	69
4.1	Introduction	69
4.2	System class	72
4.3	NMPC output feedback controller: Setup	73
4.3.1	State feedback NMPC	73
4.3.2	High gain observer	74
4.4	Nominal output feedback NMPC using high-gain observers	75
4.5	Robustness to input uncertainties	77
4.5.1	Nominal system class and assumptions on the NMPC state feedback controller	77

4.5.2	Robust exponential stability of the state feedback NMPC controller	79
4.5.3	Robust output feedback stability	81
4.6	Discussion of results	82
4.7	Illustrating example - control of an inverted pendulum	82
4.8	Conclusions	85
5	Output Feedback Nonlinear Model Predictive Control - Stability and Performance	89
5.1	Introduction	89
5.2	System class and observability assumptions	92
5.3	Output feedback NMPC controller	94
5.3.1	NMPC “open-loop” state feedback	94
5.3.2	State recovery by high-gain observers	96
5.3.3	Overall output feedback setup	100
5.4	Practical stability	102
5.4.1	Preliminaries	103
5.4.2	Boundedness of the states	108
5.4.3	Semi-global practical stability	110
5.5	Convergence to the origin	113
5.6	Discussion	118
5.7	Conclusions	120
III	State Feedback Control of Positive Systems	123

6	A State Feedback “Total Mass” Controller for a Class of Positive Systems	125
6.1	Introduction	125
6.2	Model class	127
6.3	State feedback total mass controller	130
6.3.1	The state feedback controller and a general convergence result	130
6.3.2	Regions of attraction	134
6.3.3	Conservatism	136
6.4	Robustness and stability properties	137
6.4.1	Stability of equilibria	137
6.4.2	Robustness	140
6.4.3	Asymptotic stability of Ω	142
6.5	Simple examples	143

6.5.1	Tanks in series	144
6.5.2	Food-chain systems	147
6.5.3	System with limit cycle	149
6.5.4	Van der Vusse reactor	150
6.6	Stabilization of flow in gas-lifted oil wells	156
6.6.1	Gas-lifted oil wells	156
6.6.2	A model of a gas-lifted oil well	159
6.6.3	State feedback control	162
6.6.4	Analysis	163
6.6.5	Performance	165
6.6.6	State feedback simulation results using simple model	166
6.6.7	OLGA simulations	168
6.6.8	Discussion of gas-lift stabilization controller	171
6.7	Discussion and concluding remarks	172
7	Conclusion	173
7.1	Piecewise affine output feedback	173
7.2	Output feedback NMPC	174
7.3	State feedback control of a class of positive systems	174
	Bibliography	177
A	The Gradient and Hessian of the Augmented Lagrangian Function	189
B	A Simple Model for Pressure Drop in a Vertical Well with Two-phase Flow	191
B.1	Introduction	191
B.2	Pressure drop and hold-up	193
B.2.1	Solution approach: An illustrating example	194
B.2.2	Basic variables and assumptions	195
B.2.3	Density/pressure profile ODE	198

Chapter 1

Introduction

The contributions of this thesis are within the area of control of systems described by nonlinear state-space models. Three separate problems are treated: Synthesis of observer-based output feedback controllers for a class of piecewise affine difference inclusions, the output feedback problem for nonlinear predictive control, and the control of a special class of positive systems.

Most control approaches require a model of the system that should be controlled. In many situations it is hard to obtain accurate models. Therefore, control approaches that can guarantee closed-loop stability for models with uncertainties are of practical value.

It is also important to be able to control a system even if the whole system state is not available to the controller. In this situation, it is a common approach to use an observer to reconstruct the state, such that a stabilizing controller can use the information in the observer as if it were the real state (certainty equivalence). While this approach can guarantee global stability in the linear case (by the separation principle), there is no such general conclusion for nonlinear systems. To conclude more than local stability, one must in general analyze the nonlinear system *with* the observer. This is the outset for the first part of this thesis; Chapter 2 and 3.

In the process industry, model predictive control (MPC) has become an important control strategy, mainly due to its ability to optimize performance under constraints for rather large scale processes. Especially MPC using linear models for prediction has found widespread application. However, nonlinear models and constraints become more important as tighter product quality specifications, increasing productivity demands and tougher environmental regulations require processes to be operated closer to the boundary of the admissible operating region. In Part II, Chapter 4 and 5, we look at how

the use of state observers affects stability of MPC schemes using nonlinear models.

While the first chapters treat rather general system classes, the last part of the thesis, Chapter 6, proposes a set-stabilizing controller for a special class of nonlinear systems with positive state variables. Set-stabilizing means that rather than stabilizing an equilibrium, the controller aims at stabilizing a set. The specific example that inspired the theoretical contribution of this chapter is the stabilization of a gas-lifted oil well.

Nonlinear control aims at shaping the dynamic behavior of nonlinear dynamical systems. Hence, qualitative concepts and tools from nonlinear dynamical systems theory are crucial for nonlinear control. Some relevant definitions and theorems for the contributions of this thesis are briefly rehearsed in the first part of the introduction. Thereafter, some comments are given on how these tools often are used in nonlinear control, before some issues related to output feedback control of nonlinear systems are discussed. The main contributions of the thesis are pinpointed in Section 1.4, and an outline of the thesis is provided in Section 1.5.

1.1 Some qualitative concepts and tools

The main purpose of this section is an attempt to present the stability concepts used in this thesis, and place them in a broader context. The list of qualitative concepts and tools is by no means exhaustive, and several important concepts and tools in the theory of nonlinear dynamical systems and nonlinear control are omitted.

The system class considered in this chapter, is described by a (possibly time-varying) ordinary differential equation (ODE),

$$\dot{x} = f(t, x) \tag{1.1}$$

(or, in the discrete time case, a time-varying difference equation $x_{k+1} = f_k(x_k)$). In general, $f : [0, \infty) \times \mathcal{D} \rightarrow \mathbb{R}^n$, where the domain $\mathcal{D} \subset \mathbb{R}^n$ contains the origin $x = 0$. We will often assume that the origin is an equilibrium, which means $f(t, 0) \equiv 0$. With a slight abuse of notation, we refer to a solution of (1.1) starting from an initial condition $x(t_0) \in \mathcal{D}$ at time t_0 , by $x(\cdot)$. The solution at a specific time $t > t_0 \geq 0$ is, when it exists, called $x(t)$ and satisfies

$$\frac{d}{dt}x(t) = f(t, x(t)).$$

We assume that f is piecewise continuous in t and locally Lipschitz in x , which guarantee existence and uniqueness of $x(\cdot)$, at least in a short in-

terval. Uniqueness and existence in the discrete time case is automatically guaranteed by f_k being a function.

The most important references for the material in this section, are Khalil (2002), Rouche, Habets and Laloy (1977), Teel (2001) and LaSalle (1960).

In what follows, $\alpha : [0, \infty) \rightarrow [0, \infty)$ is class \mathcal{K} ($\alpha \in \mathcal{K}$) if α is continuous, strictly increasing and $\alpha(0) = 0$. Further, $\beta : [0, \infty) \times [0, \infty) \rightarrow [0, \infty)$ is class \mathcal{KL} if it is continuous, strictly increasing in the first argument, non-increasing in its second argument, and $\lim_{r \rightarrow 0^+} \beta(r, s) = \lim_{s \rightarrow \infty} \beta(r, s) = 0$. A *region* is the union of an open, connected set with some, none, or all its boundary points. A *domain* (open region) is a region with none of the boundary points included (Khalil, 2002, p. 649).

The most important stability concept, at least if rated in terms of publications, is that of asymptotic stability (in the sense of Lyapunov).

“It is never possible to start the system exactly in its equilibrium state, and the system is always subject to outside forces not taken into account by the differential equations. The system is disturbed and is displaced slightly from its equilibrium state. What happens? Does it remain near the equilibrium state? This is stability. Does it remain near the equilibrium state and in addition tend to return to the equilibrium? This is asymptotic stability.” (LaSalle, 1960)

If the asymptotic stability is independent of the initial time, then it is *uniform*:

Definition 1.1 (Uniform asymptotic stability) *If there exists a $\beta \in \mathcal{KL}$ and a $b > 0$, independent of t_0 , such that the solution of (1.1) satisfies*

$$\|x(t)\| \leq \beta(\|x(t_0)\|, t), \quad \forall t \geq t_0 \geq 0, \forall \|x(t_0)\| \leq b \quad (1.2)$$

then the origin is uniformly asymptotically stable.

If b can be taken arbitrarily large, then the origin is uniformly globally asymptotically stable.

Note that normally, uniform asymptotic stability is defined in terms of the solution being uniformly stable and uniformly attractive, which is equivalent to Definition 1.1:

Theorem 1.1 *The origin is uniformly asymptotically stable if and only if*

- *The origin is uniformly locally stable: Given $\epsilon > 0$, there exists $\delta > 0$, independent of t_0 , such that $\|x(t_0)\| \leq \delta \Rightarrow \|x(t)\| \leq \epsilon, \forall t \geq t_0 \geq 0$.*

- *The origin is uniformly attractive: For all $\|x(t_0)\| \leq b$, where b is independent of t_0 , $\lim_{t \rightarrow \infty} x(t) = 0$.*

There exist a number of methods for showing uniform asymptotic stability, but the most widely used is Lyapunov's second method (also known as Lyapunov's direct method):

Theorem 1.2 (Lyapunov) *Let $\mathcal{D} \subset \mathbb{R}^n$ be a domain containing the origin. Let $V : \mathcal{D} \rightarrow [0, \infty)$ be a continuously differentiable function. If there exist class \mathcal{K} -functions α_i , $i \in 1, 2, 3$ such that*

$$\alpha_1(\|x\|) \leq V(x) \leq \alpha_2(\|x\|) \tag{1.3a}$$

$$\frac{\partial V}{\partial x} f(t, x) \leq -\alpha_3(\|x\|) \tag{1.3b}$$

for all $t \geq t_0$ and for all $x \in \mathcal{D}$, then $x = 0$ is uniformly asymptotically stable.

Instead of finding a $\mathcal{K}\mathcal{L}$ -bound on the trajectories as is required in Definition 1.1, by this theorem it suffices to look for an auxiliary function V with some desired properties. In many cases, this turns out to be easier. The proof of the Lyapunov theorem consists of showing that the properties of V imply that there exists a class $\mathcal{K}\mathcal{L}$ -function as in Definition 1.1.

Mere asymptotic stability, as given in Definition 1.1, is often of limited value, since it might be valid only in a small neighborhood of the origin (LaSalle, 1960). It is of interest to know how far away from the origin convergence to the origin still holds. This region of initial conditions is called *region of attraction*, R_A . From Theorem 1.1, we see that the stability property is a local property, so in this respect only attractivity is important.

If the conditions of Theorem 1.2 are fulfilled, an estimate for R_A can be found as the largest Lyapunov level set contained in \mathcal{D} , determined by the largest c such that $\Omega_c := \{x \mid V(x) \leq c\} \subset \mathcal{D}$. If all the conditions in Theorem 1.2 are satisfied for all $x \in \mathbb{R}^n$ and $\alpha_1(\|x\|) \rightarrow \infty$ when $\|x\| \rightarrow \infty$, then Theorem 1.2 implies *global* asymptotic stability (that is, convergence holds for all initial values in \mathbb{R}^n).

Remark 1.1 *Theorems 1.1 and 1.2 (appropriately rephrased) also hold if one instead of the origin considers stability of a compact subset \mathcal{A} of \mathbb{R}^n . The norm $\|\cdot\|$ should then be substituted with the distance from the set \mathcal{A} , $|x|_{\mathcal{A}} := \inf_{y \in \mathcal{A}} \|x - y\|$. If f is time invariant, then (1.3b) can be taken as $\frac{\partial V}{\partial x} f(x) < 0$, and the bound on the Lyapunov function provided by $\alpha_2(\cdot)$ is not needed.*

An important sub-case of Definition 1.1 is when we take $\beta(r, s) = kre^{-\gamma s}$. This defines (uniform) *exponential* stability. If we take $\alpha_i(\|x\|) = k_i\|x\|^d$ for positive k_i and d , then the conditions of Theorem 1.2 imply exponential stability. As a special case, if the Lyapunov function is quadratic, $V(x) = x^\top Px$ and $\frac{\partial V}{\partial x}f(t, x) \leq -x^\top Qx$ for some positive definite P and Q , the stability is sometimes referred to as *quadratic stability* (Corless, 1994). The fact that quadratic stability implies exponential stability is clear.

For discrete-time systems, conditions corresponding to the above theorems and definitions can be given. We do not detail this, but we include the following definition for quadratic stability of discrete time systems:

Definition 1.2 (Discrete time quadratic stability) *The system $x_{k+1} = f_k(x_k)$ has a quadratically stable equilibrium at the origin if there exists positive definite matrices P and Q and a domain \mathcal{D} containing the origin such that*

$$f_k(x)^\top P f_k(x) - x^\top P x \leq -x^\top Q x \quad \forall x \in \mathcal{D} \text{ and } \forall k \geq 0.$$

Akin to this definition is the stability definition used in Part I of the thesis.

Sometimes, finding a Lyapunov function with negative definite derivative is hard. It can also be that a natural Lyapunov function (often related to energy or mass) is not positive definite. In these cases, LaSalle's invariance principle (LaSalle, 1960, Khalil, 2002) can be useful:

Theorem 1.3 (LaSalle) *Let $\Gamma \subset \mathcal{D}$ be a compact set that is positively invariant with respect to $\dot{x} = f(x)$. Let $V : \mathcal{D} \rightarrow \mathbb{R}$ be a continuously differentiable function such that $\dot{V}(x) \leq 0$ in Γ . Let E be the set of all points in Γ where $\dot{V}(x) = 0$. Let M be the largest invariant set in E . Then every solution starting in Γ approaches M as $t \rightarrow \infty$.*

Note that in this case, the Lyapunov function does not have to be definite. However, if $V(x)$ is positive definite, and the only solution that can stay in the set $\dot{V}(x) = 0$ is $x(t) \equiv 0$, then attractivity of the origin follows from LaSalle's invariance principle, and stability holds since $\dot{V}(x) \leq 0$. Thus asymptotic stability can be concluded by Theorem 1.1¹. Some stability results for $V(x)$ positive *semidefinite* can be found in Chabour and Kalitine (2002).

Also noteworthy is the fact that LaSalle's principle only holds for time-invariant (non-autonomous) systems. In the non-autonomous case, one must

¹This corollary, known as the Theorem of Barbashin and Krasovskii, was proved independently much earlier.

resort to weaker alternatives, such as Matrosov's Theorem or the LaSalle-Yoshizawa Theorem, see for example Rouche et al. (1977), Khalil (2002). The proof of the latter is based on Barbalat's lemma:

Lemma 1.1 (Barbalat's lemma) *Let $\phi : \mathbb{R} \rightarrow \mathbb{R}$ be a uniformly continuous function on $[0, \infty)$. Suppose that $\lim_{t \rightarrow \infty} \int_0^t \phi(\tau) d\tau$ exists and is finite. Then,*

$$\phi(t) \rightarrow 0 \quad \text{as } t \rightarrow \infty.$$

In a typical use of the lemma, ϕ is an (implicit) continuous function of the (norm of the) state, $\phi(t) = \tilde{\phi}(\|x(t)\|)$, and $\tilde{\phi}(a) = 0 \Rightarrow a = 0$. In this case, the lemma can be used to show asymptotic convergence, but further arguments are needed to conclude stability.

In many cases, convergence to the origin does not hold. For instance, it can be that we want to analyze a nonlinear system subject to norm-bounded perturbations that do not vanish at the origin, $\dot{x} = f(t, x) + g(t, x)$, $\|g(t, x)\| \leq \bar{g}$. Then, $x = 0$ is in general no longer an equilibrium, and asymptotic stability cannot hold (in general²). The appropriate concept to look for is then, for a given set of initial conditions, that $\|x(t)\|$ becomes small (where "small" may be related to the size of the perturbation) after some period of time. There exist several closely related definitions of this concept, for instance the *uniform ultimate boundedness* concept, see for example LaSalle and Lefschetz (1961), Khalil (2002):

Definition 1.3 (Uniform ultimate boundedness) *The solutions of $\dot{x} = f(t, x)$ are said to be uniformly ultimately bounded if there exist positive constants b and c , and for every $\alpha \in (0, c)$ there is a positive constant $T = T(\alpha)$ such that*

$$\|x(t_0)\| \leq \alpha \Rightarrow \|x(t)\| \leq b, \quad \forall t \geq t_0 + T. \quad (1.4)$$

They are said to be globally uniformly ultimately bounded if (1.4) holds for arbitrarily large α .

Related to this concept are the notions of practical stability (LaSalle and Lefschetz, 1961), total stability (stability under persistent disturbances) (Hahn,

²For a system subject to control, it is possible to design controllers such that the closed loop becomes asymptotically stable even in the presence of (matched) non-vanishing perturbations. One example of this, is *Lyapunov Min-Max controllers* (Gutman, 1979, Corless, 1994); however, these controllers are discontinuous. Another, very related, example is switching controls, which leads to *variable structure* systems that eliminate disturbances by introducing *sliding modes* (Utkin, 1992). Note that a continuous implementation of Lyapunov Min-Max controllers leads to uniform ultimate boundedness (Corless and Leitmann, 1981).

1967) and semiglobal practical stabilizability (Teel and Praly, 1995). Total stability/practical stability describe the property where b in the above definition can be chosen arbitrarily small, for small enough initial conditions and small enough perturbations (small enough \bar{g}).

“Practical stability is a uniform boundedness of solutions relative to the set of initial conditions Q_0 and the class of perturbations P . It is, however, not merely that the bound exists but that the bound be sufficiently small; the solutions starting in Q_0 are to remain in Q .” (*LaSalle and Lefschetz, 1961*)

The semiglobal practical stabilizability property of Teel and Praly (1995) is a property of a *controlled* nonlinear system that also takes the “region of attraction” into consideration. For an arbitrarily large set of initial conditions (which may be within a maximal set), and an arbitrarily small set containing the origin, this property implies the existence of a (dynamical) controller that make the closed loop state enter, and stay within, the small set. The corresponding stability property, semiglobal practical stability, is used in Chapter 5.

The notion of practical stability can pertain to other terms than size of perturbations. For example, under a sample-and-hold implementation of a continuous time control law, it cannot in general be guaranteed that the state converges to the origin. Instead, the size of the set (containing the origin) that the state converges to, typically depends on the sampling rate:

“...since sampling is involved, when near the origin it is impossible to guarantee arbitrarily small displacements unless a faster sampling rate is used...” (*Clarke, Ledyaev, Sontag and Subbotin, 1997*)

As in the tools for showing stability, Theorem 1.2 and 1.3, the means for showing practical stability properties are typically the application of an auxiliary scalar function of the state.

1.2 Finding a Lyapunov function

As shown in the previous section, the tools used for proving system stability properties, usually amount to finding an auxiliary scalar function of the state with some desired properties. Often, this auxiliary function is called a *Lyapunov function*, even when the desired properties are not the same as in Lyapunov’s second method.

In a control setting, one typically wants to find a control law in addition to the Lyapunov function. For a controlled dynamical system, $\dot{x} = \tilde{f}(t, x, u)$,

a general state³ feedback control law can be written $u = \kappa(t, x)$, and the challenge is to find *both* a control law *and* a Lyapunov function such that the Lyapunov function has the desired properties for the closed loop system $\dot{x} = \tilde{f}(t, x, \kappa(t, x)) =: f(t, x)$.

We claim that there are two main approaches on finding Lyapunov functions (and corresponding control laws). We refer to these as the *analytical* approach and the *numerical* approach. Of the approaches in this thesis, the two first parts use the numerical approach, while the last part uses the analytical approach.

Analytical approach System models may be obtained from first principles, for example energy or mass balances. In this case, a good candidate for a Lyapunov function is the system's total energy or mass, or some related property. Important concepts in this regard are energy-based control, passivity, dissipativity, and the consideration of special system classes, for example Hamiltonian systems, Euler-Lagrange systems and thermodynamic systems. There is a vast amount of literature on these topics, see for example Desoer and Vidyasagar (1975), van der Schaft (2000), Ortega, Van Der Schaft, Mareels and Maschke (2001), Ydstie and Alonso (1997).

Some systems possess *first integrals*, that is, a function of the state that is constant under the system dynamics. These can in some cases be used to construct Lyapunov functions (Rouche et al., 1977).

Numerical approach The invention of effective interior point methods for solving linear matrix inequalities⁴ (LMIs) (Nesterov and Nemirovskii, 1994, Boyd, El Ghaoui, Feron and Balakrishnan, 1994, Wolkowicz, Saigal and Vandenberghe, 2000), has over the last decade lead to a large number of publications on using these methods for finding Lyapunov functions for a number of system classes. The structure of LMIs implies that most of the system classes that are treated are linear, in some form. However, uncertainty and nonlinearity can be handled as long as they have a "linear" description, for example, linear parameter-varying (LPV) systems, linear differential/difference inclusions (LDIs) and piecewise linear/affine (PWA) systems. Some of the more important results that have appeared, are on \mathcal{H}_∞ -methods (Gahinet and Apkarian, 1994, Iwasaki and Skelton, 1994), systems with (structured) uncertainties (Boyd et al., 1994, Doyle, Packard and Zhou, 1991, Scherer, 2001), and robust MPC methods (Kothare, Balakrishnan and Morari, 1996, Kouvaritakis, Rossiter and Schuurmans, 2000). A

³For comments on *output* feedback, see the next section.

⁴Also known as semidefinite programming (SDP).

good introduction to LMIs in control can be found in Scherer and Weiland (1999).

Other numerical approaches also exist, for example methods based on gridding the state space to find a (suitably parameterized) decreasing Lyapunov function, see e.g. Johansen (2000).

A third option, related to the numerical approach, is often used in approaches based on online optimization (for instance, model predictive control). In these approaches one online minimizes a function of the state, the *objective function*, which measures in some sense the system performance. The value function is obtained by inserting the “real” state trajectory into the objective function. The value function will often serve as a Lyapunov function (Mayne, Rawlings, Rao and Scokaert, 2000).

1.3 Output feedback

As the approaches in Part I and II of this thesis treat output feedback, some remarks on this problem is appropriate.

Given a (time-invariant, for simplicity) dynamical system

$$\begin{aligned}\dot{x} &= f(x, u), \\ y &= g(x)\end{aligned}$$

where $x \in \mathbb{R}^n$, $y \in \mathbb{R}^m$ and $m < n$. Stabilization by output feedback means finding an algorithm using the information contained in $y(\cdot)$ to (causally) generate $u(\cdot)$ such that $\dot{x}(t) = f(x(t), u(t))$ is asymptotically stable. Important specializations are *static* output feedback, where $u = \kappa(y)$ for some mapping κ , and *dynamic* output feedback, where the control input in addition to y , depends on the state of a dynamic system driven by y (as in $u = \kappa_1(z, y)$, $\dot{z} = \kappa_2(z, y)$). An important sub-case of dynamic output feedback is observer-based output feedback.

In general, stabilization by output feedback is harder than stabilization by state feedback, since less information is available. For linear (time-invariant, unconstrained) systems, most aspects of state feedback stabilization are known by now (see for example Wonham (1985)). On the other hand, the general problem of finding a static linear output feedback (equivalent to finding a reduced order dynamic output feedback), is still an open problem (Apkarian and Tuan, 1999, Blondel and Tsitsiklis, 1999). Even though several good algorithms exist by now, see e.g. El Ghaoui, Oustry and AitRami (1997), no known algorithms can in general find a stabilizing static output feedback in polynomial time, even in the case where there might ex-

ist one. Since this problem has received considerable attention, one might suspect the problem to be NP-hard, but this has not been proven.

The full order dynamic output feedback problem (for linear systems), on the other hand, can as the state feedback problem be formulated as a convex optimization problem. The full order case (which means that the dimension of the dynamic part of the controller is the same as the dimension of x) includes observer-based output feedback as a special case.

An important rationale for using observer-based state feedback is that this allows us to use a state feedback controller, which by design often has desirable features related to system performance. Also important is the notion of a *separation principle*. In the case of linear systems, using linear state feedback coupled with a linear state observer result in (global) asymptotic closed-loop stability if the observer-error dynamics and the closed-loop process under pure state feedback are both asymptotically stable (Luenberger, 1966). The assignment of the closed loop eigenvalues can be carried out as separate tasks for the state feedback and observer problems, hence the separation principle holds. The practical implication is that one can design the state feedback without having the observer in mind, at least as long as only stability is considered.

For nonlinear systems, this “certainty equivalence” approach is not guaranteed to work (see e.g. the counterexample in Krstić, Kanellakopoulos and Kokotović (1995, p. 285)). Hence, in general system stability should be analyzed by including the observer dynamics in the closed loop. This is the approach taken in Chapter 3. However, recent developments show that for rather general classes of nonlinear systems, it is possible to establish a nonlinear separation principle. These results say that it is possible to design fast observers such that the state feedback performance (including stability, region of attraction and trajectories) is approximately recovered in the output feedback case (Teel and Praly, 1994, Atassi and Khalil, 1999). In Chapter 4 and 5, a similar angle of attack is used within the context of nonlinear model predictive control.

1.4 Contributions

The main contributions of this thesis are as follows:

Part I Observer-based piecewise affine output feedback

- Synthesis inequalities in the form of bilinear matrix inequalities for piecewise affine observer-based output feedback for a class of piecewise affine difference inclusions (Section 3.3).

- A separated synthesis procedure for the controller structure in Section 3.3 (Section 3.4).
- Adapting a solver for the class of synthesis inequalities (Section 2.4).

Part II Output feedback Nonlinear Model Predictive Control

- Robust stability results for instantaneous NMPC (Section 4.5).
- Practical stability for NMPC using high gain observers (Section 5.4).
- Under some additional assumptions, also convergence to the origin is achieved (Section 5.5).

Part III State feedback control of a class of positive systems

- A new stabilizing state feedback controller for a class of positive systems (Section 6.3).
- Application of the state feedback controller to the stabilization of a gas-lifted oil well (Section 6.6).

1.5 Thesis outline

Chapter 2 contains a recapitulation of the main theorem of Slupphaug, Imsland and Foss (2000) (which builds on Slupphaug (1998), Slupphaug and Foss (1999)). Briefly, it states synthesis inequalities in the form of bilinear matrix inequalities (BMIs) for synthesizing (piecewise affine) controller structures that stabilize a class of systems that can be represented by piecewise affine difference inclusions. It is a slight generalization of Slupphaug et al. (2000), allowing a more general closed loop. A solver for the BMIs, adopted from the solver in Fares, Apkarian and Noll (2001), is also suggested.

In Chapter 3, the result in Chapter 2 is used to develop synthesis inequalities for an observer based piecewise affine controller structure. First, a combined synthesis is developed that searches for the observer output injection and the (observer) state feedback simultaneously. Second, a separated procedure is developed, where the state feedback synthesis is performed as in Slupphaug et al. (2000), and then the observer synthesis equalities ensure total closed loop stability. Although less general, the separated approach is shown to possess some favorable properties. Two examples demonstrate some of the features of the controller structure. The results of this chapter are presented in Imsland, Slupphaug and Foss (2001c,d,e).

In Chapter 4, the output feedback problem for NMPC is approached using observers for state estimation. It is assumed that a instantaneous (time

continuous) version of NMPC is used, that is, the NMPC open loop optimization problem is solved at all times. The state estimation is performed with a high gain observer. It is pointed out that under a continuity assumption on the solution of the NMPC optimal control problem, the separation principle of Atassi and Khalil (1999) still holds. This means that for a rather general system class, there exist observers such that output feedback asymptotic stability holds. In addition, the trajectories (and hence performance and region of attraction) of the state feedback NMPC can be retrieved to any desired degree of accuracy in the output feedback case. Further, it is demonstrated that this still holds for a class of unknown (unmodeled) input nonlinearities. An example illustrates the procedure. The results of this chapter are published in Imsland, Findeisen, Bullinger, Allgöwer and Foss (2001a,b).

The assumption of an infinitely fast sampling rate is dispensed with in Chapter 5. It is established that a practical stability property holds for the NMPC closed loop with a high gain observer. That is, for a fast enough sampling rate and fast enough observer, the state ultimately enters, and stays within, a (small) set containing the origin. Furthermore, convergence to the origin is shown under some stronger assumptions. A preliminary version of some of the results in this chapter is presented in Findeisen, Imsland, Allgöwer and Foss (2002a), and the results of Section 5.4 are submitted for journal publication (Findeisen, Imsland, Allgöwer and Foss, 2002b). The results of Section 5.5 can be found in Imsland, Findeisen, Allgöwer and Foss (2002).

In Chapter 6, we propose a state feedback controller for a class of positive systems. The approach is inspired by the controller proposed by Bastin and Praly (1999), but a substantially larger system class is treated, including systems with more than one input, systems with controlled outflow and systems with saturated inputs. The controller stabilizes a subset of the state space, corresponding to a certain mass configuration in the system. Conditions are given under which the stability of this set implies an asymptotically stable equilibrium. Moreover, it is shown that the controller possesses some robustness properties. Some aspects of the controller are illustrated through simple examples. The particular example that inspired the development of the controller, stabilization of a gas-lifted oil well, is treated in more detail. The results of this chapter are being prepared for publication.

Part I

Piecewise Affine Robust
Output Feedback

Chapter 2

A Synthesis Result for Piecewise Affine Difference Inclusions

This chapter presents a synthesis result for a class of uncertain nonlinear discrete time systems, represented in the form of a piecewise affine difference inclusion. The synthesis is based on solving a set of bilinear matrix inequalities (BMIs), hence a solver for the BMI problem is also presented.

The synthesis result is based on Slupphaug et al. (2000), with some limited extensions. The solver (based on a solver in Fares et al. (2001)) was presented in Imsland et al. (2001c) (see also Imsland et al. (2001d)). The synthesis result of this chapter forms a basis for the output feedback synthesis results of Chapter 3.

2.1 Introduction

Piecewise affine systems have been studied for some time. The main motivation seems to be, at least originally, the use of piecewise affine systems as approximations for nonlinear systems, see e.g. Sontag (1981). Later, also modeling hybrid systems as piecewise affine systems has been an object for research, see e.g. Bemporad, Ferrari-Trecate and Morari (2000), Johansson and Rantzer (1998) for some recent contributions.

From the use of piecewise affine systems as models for nonlinear systems, the idea of implementing nonlinear control by piecewise affine controllers follows naturally. Piecewise affine controller structures have recently gained considerable interest, in particular as explicit solutions of linear MPC (Bem-

porad, Morari, Dua and Pistikopoulos, 2002, Johansen, Petersen and Slupphaug, 2002), but also more generally, e.g. Hassibi and Boyd (1998).

In this chapter, quite general piecewise affine difference inclusions are considered, and a synthesis result for synthesizing general (piecewise affine) controller structures for this system class is given.

The main result in this section, Theorem 2.1, is a slight generalization of the result in Slupphaug et al. (2000), in that a more general system class is allowed. The system class considered in Slupphaug et al. (2000) is then a special case of the one considered here, apart from the fact that the closed loop system in Slupphaug et al. (2000) can have parameters that enter quadratically in the equations. For simplicity, this is not considered here, although the approach used in Slupphaug et al. (2000) for this could be used for the system class considered herein as well.

In Section 2.4, an algorithm for solving the matrix inequalities is developed, based on an algorithm given in Fares et al. (2001) for solving similar matrix inequalities. The algorithm makes use of general purpose LMI-solvers.

2.2 Model class

2.2.1 Piecewise affine difference inclusions

The system dynamics is represented by affine (in the state) difference inclusions on subsets X_l of the state space (model validity set) X_m , $X_l \subset X_m \subset \mathbb{R}^n$, hence we call the model class *piecewise affine difference inclusions*. The subsets X_l (the *local model validity sets*) may be overlapping, and the union of all N subsets cover all of X_m , $X_m \subset \cup_{l \in \{1, \dots, N\}} X_l$.

The difference inclusion on local model validity set X_l is

$$x_{k+1} \in \mathcal{M}_l(x_k, \Theta; K^l), \forall k \in \mathbb{N}, x_k \in X_l. \quad (2.1)$$

Here, K^l is a set of parameters that should be found for the difference inclusion to be stable. This will be elaborated on later. As indicated, the set-valued mapping \mathcal{M}_l is affine in the state,

$$\mathcal{M}_l(x_k, \Theta; K^l) := \{x^+ \mid \exists \theta_k \in \Theta, x^+ = A^l(\theta_k; K^l)x_k + c^l(\theta_k; K^l)\} \quad (2.2)$$

where for the X_l which contains the origin in its closure, $c^l(\theta_k; K^l) \equiv 0$.

Further, $A^l(\theta_k; K^l)$ and $c^l(\theta_k; K^l)$ are affine,

$$A^l(\theta_k; K^l) := A_0^l(K^l) + \sum_{j=1}^{N_\theta} A_j^l(K^l)\theta_{k,j}$$

$$c^l(\theta_k; K^l) := c_0^l(K^l) + \sum_{j=1}^{N_\theta} c_j^l(K^l)\theta_{k,j},$$

in the elements of the (possibly) time-varying parameter vector $\theta_k = (\theta_{k,1}, \dots, \theta_{k,N_\theta})^\top$, and N_θ is the number of parameters. The parameter vector is assumed to be in a hyper-rectangle (or parameter box)

$$\Theta := \left\{ \theta = (\theta_1, \dots, \theta_{N_\theta})^\top \mid \forall j \in I_{N_\theta}, \theta_j \in [0, 1] \right\} = [0, 1]^{N_\theta}.$$

It may seem restrictive to allow all the parameters only to be in the interval $[0, 1]$ but a simple scaling argument shows that this can always be obtained (assuming, of course, that the parameter is indeed partially unknown with known upper and lower bounds). The same scaling argument implies of course that the parameters' bounds can be made equal to Θ in all the local model validity sets.

The functions defined above are also assumed affine in the controller parameters K^l . In general, K^l should be taken as a set of matrices, and will be defined according to the specific stabilization problem that is considered.

The above difference inclusion could for instance be a description of closed loop nonlinear and/or uncertain systems with known equilibrium input, with some piecewise affine controller structure. The state feedback (and the output feedback, if linear output is assumed) closed loop from Slupphaug et al. (2000) fits this setup, as does the output feedback closed loop of the next chapter. Also, certain classes of hybrid systems can fit this system description (Slupphaug, 1998).

2.2.2 Set approximations

We have not said anything about the shape of the X_l s, and we make no assumptions about them other than the union of the X_l s should cover X_m . However, we have to outer approximate the X_l s to cover them in the synthesis inequalities to come. This is done in the same manner as in Slupphaug and Foss (1999).

When formulating the conditions for affine quadratic constrained stabilization, it is sensible to approximate the X_l s and the model validity set

(state constraints) X_m using polytopes or ellipsoids¹. The X_l s containing the origin in their closure are outer approximated by unbounded polytopes, and are indexed with $l \in 1, \dots, N^o$, the X_l s *not* containing the origin in their closure are outer approximated either by possibly bounded polytopes and indexed in $\{N^o + 1, \dots, N^p\}$, or by ellipsoids and indexed in $\{N^p + 1, \dots, N\}$. Note that N^o is the number of intersection sets containing the origin in their closure, while N^p is the number of intersection sets outer approximated by polytopes, and N is the total number of non-empty intersection sets.

Thus, for $l \in I_{N^o}$ the polytope

$$\{x \mid E_l x \leq 0\} \supset X_l \quad (2.3)$$

is used as an *outer approximation* of X_l . For $l \in \{N^o + 1, \dots, N^p\}$, assume that the polytope

$$\{x \mid [E_l \quad e_l] \begin{bmatrix} x \\ 1 \end{bmatrix} \leq 0\} \supset X_l \quad (2.4)$$

is used, and, finally, for $l \in \{N^p + 1, \dots, N\}$, assume that the ellipsoid

$$\{x \mid \begin{bmatrix} x \\ 1 \end{bmatrix}^\top \begin{bmatrix} E_l & e_l \\ e_l^\top & \epsilon_l \end{bmatrix} \begin{bmatrix} x \\ 1 \end{bmatrix} \leq 0\} \supset X_l \quad (2.5)$$

is used.

Often, the sets to be covered will be given as polytopes. If we consider the sets not containing the origin in their closure, they can be covered by either polytopes or ellipsoids. Using polytopes will in general be less conservative; however, more variables are needed when including the polytopic coverings using the \mathcal{S} -procedure, as will be seen. Also, the resulting covering will in both cases be an ellipsoid. Using ellipsoids as coverings can be seen as forming them beforehand, saving variables in the synthesis procedure. Further details on this can be found in Johansson (1999).

Furthermore, assume that the state-space model validity- and constraint set X_m is *inner approximated* as follows²

$$0 \in \bigcap_{i \in I_{N_{qx}}} \{x \mid \|x - x_{i,c}\|_{H_i,x}^2 \leq 1\} \subset X_m, \quad (2.6)$$

i.e. by an intersection of ellipsoids where $x_{i,c}$ are the centers of the ellipsoids, and N_{qx} is the number of ellipsoids.

¹If tighter approximations are needed, one can use *unions* of polytopes or ellipsoids. This extension is trivial (Slupphaug, 1998).

² $\|x\|_H := \sqrt{x^\top H x}$, $H > 0$.

Note that any of the outer approximations (2.3), (2.4) and (2.5), exists for any set, and that they are the natural outer approximations to choose when formulating LMI problems for piecewise linear (and affine) systems (Hassibi and Boyd, 1998, Johansson, 1999).

The inner approximation (2.6) exists for any X_m with the origin in the interior, and the origin can and should be placed in the interior of each of the intersections.

2.3 Affine stability and synthesis inequalities

2.3.1 Stability definition

We will use the following stability notion; see e.g. Slupphaug and Foss (1999) and Scherer and Weiland (1999) for similar definitions.

Definition 2.1 (Affine quadratic stability) *Given the system*

$$x_{k+1} = A(\theta_k, x_k)x_k + c(\theta_k, x_k), \quad (2.7)$$

where $k \in \mathbb{N}$, $x_k \in X_m \subset \mathbb{R}^n$, x_0 given and $c(\theta_k, 0) = 0$ for all $\theta_k \in \Theta \subset \mathbb{R}^{N_\theta}$. Define the (affine) Lyapunov matrix function $P(\theta_k) = P_0 + \sum_{j=1}^{N_\theta} \theta_{k,j} P_j$. The origin is an affinely quadratically stable equilibrium for the system (2.7) if there exists a domain $D \subset X_m$ and symmetric matrices $M > 0$, $P_0, P_1, \dots, P_{N_\theta}$ such that for all $x_k \in D$, $\theta_k, \theta_{k+1} \in \Theta$

$$\begin{aligned} (A(\theta_k, x_k)x_k + c(\theta_k, x_k))^\top P(\theta_{k+1})(A(\theta_k, x_k)x_k + c(\theta_k, x_k)) \\ - x_k^\top P(\theta_k)x_k \leq -x_k^\top Mx_k \end{aligned} \quad (2.8)$$

$$P(\theta_k) > 0. \quad (2.9)$$

If, in addition, there exist scalars $\alpha_0, \alpha_1, \dots, \alpha_{N_\theta}$ defining the affine function $\alpha(\theta) := \alpha_0 + \sum_{j=1}^{N_\theta} \theta_j \alpha_j > 0$ for all $\theta \in \Theta$ such that for a given set \tilde{R}_A ,

$$\tilde{R}_A \subset \left\{ x \mid \exists \theta \in \Theta, x^\top P(\theta)x \leq \alpha(\theta) \right\} \subset D,$$

then the origin is said to be an affinely quadratically stable equilibrium for the system (2.7) with a region of attraction associated with \tilde{R}_A of at least $\{x \mid \exists \theta \in \Theta, x^\top P(\theta)x \leq \alpha(\theta)\}$.

2.3.2 Synthesis inequalities

Next we derive LMIs subject to a spectral radius constraint on the product of two positive definite matrices (a specially structured BMI) for affine quadratic stabilization of the origin of (2.1). We use a quadratic parameter dependent Lyapunov function, which is more general than using a quadratic Lyapunov function that does not depend on the parameters. This will make the current approach less conservative (in the state-feedback case) than Slupphaug and Foss (1999) where a parameter independent Lyapunov function was used. This theorem is a slight generalization of Theorem 3.1 presented in Slupphaug et al. (2000).

In the following result we will need the affine functions:

$$\begin{aligned} W^l(\theta) &:= W_o^l + \sum_{j=1}^{N_\theta} \theta_j W_j^l \\ \tau^l(\theta) &:= \tau_o^l + \sum_{j=1}^{N_\theta} \theta_j \tau_j^l \\ \beta(\theta) &:= \beta_o + \sum_{j=1}^{N_\theta} \theta_j \beta_j \\ \mu^l(\theta) &:= \mu_o^l + \sum_{j=1}^{N_\theta} \theta_j \mu_j^l. \end{aligned}$$

The W_j^l s are symmetric matrices whose dimension are the row dimension of the corresponding E_l s, named n_{E_l} . The τ_j^l s, β_j s and μ_j^l s are scalars. The smallest acceptable region of attraction is specified by the positive definite matrix R_A , such that this region is given by the ellipsoid $\|x\|_{R_A} \leq 1$. In the following (and in Chapter 3), the symbol R_A will refer to both the matrix and the region. The meaning should follow from the context.

Theorem 2.1 *Let Θ_0 be the corners of the parameter box Θ , i.e. $\Theta_0 = \{0, 1\}^{N_\theta}$. Then, if $\exists M > 0$ symmetric matrices $\{P_j\}_{j=0}^{N_\theta}$, S , matrices of appropriate dimensions $\left\{ \left\{ W_j^l \right\}_{j=0}^{N_\theta} \right\}_{l=1}^{N^p}$, $\left\{ \left\{ \tau_j^l \right\}_{j=0}^{N_\theta} \right\}_{l=N^p+1}^N$ and $\{K^l\}_{l=1}^N$ such that $\forall l \in I_{N^o}, \theta \in \Theta_0$*

$$\begin{bmatrix} S & A^l(\theta; K^l) \\ \star & P(\theta) - M - E_l^\top W^l(\theta) E_l \end{bmatrix} \geq 0 \quad (2.10)$$

$\forall l \in \{N^o + 1, \dots, N^p\}, \theta \in \Theta_0$

$$\begin{bmatrix} S & A^l(\theta; K^l) & c^l(\theta; K^l) \\ \star & P(\theta) - M - E_l^\top W^l(\theta) E_l & -E_l^\top W^l(\theta) e_l \\ \star & \star & -e_l^\top W^l(\theta) e_l \end{bmatrix} \geq 0 \quad (2.11)$$

$\forall l \in \{N^p + 1, \dots, N\}, \theta \in \Theta_0$

$$\begin{bmatrix} S & A^l(\theta; K^l) & c^l(\theta; K^l) \\ \star & P(\theta) - M + \tau^l(\theta) E_l & \tau^l(\theta) e_l \\ \star & \star & \tau^l(\theta) e_l \end{bmatrix} \geq 0 \quad (2.12)$$

$\forall \theta \in \Theta_0$

$$0 < P(\theta) \leq S^{-1} \quad (2.13)$$

and $\forall l \in I_{N^p}, \theta \in \Theta_0$

$$W^l(\theta) \in \mathbb{R}_+^{n_{E_l} \times n_{E_l}}, \quad (2.14)$$

then the origin is an affinely quadratically stable equilibrium for the closed-loop system. If, in addition, there exist reals $\{\alpha_j\}_{j=0}^{N_\theta}$ and $\{\beta_j\}_{j=0}^{N_\theta}$ such that $\forall \theta \in \Theta_0$

$$\begin{bmatrix} P(\theta) - \beta(\theta) R_A & 0 \\ 0 & \beta(\theta) - \alpha(\theta) \end{bmatrix} \leq 0 \quad (2.15)$$

and reals $\left\{ \left\{ \mu_j^l \right\}_{j=0}^{N_\theta} \right\}_{l \in I_{N_{qx}}}$ such that $\forall l \in I_{N_{qx}}, \theta \in \Theta_0$

$$\begin{bmatrix} \mu^l(\theta) H_{l,x} - P(\theta) & -\mu^l(\theta) H_{l,x} x_{l,c} \\ \star & \mu^l(\theta) (x_{l,c}^\top H_{l,x} x_{l,c} - 1) + \alpha(\theta) \end{bmatrix} \leq 0, \quad (2.16)$$

then the origin is an affinely quadratically stable equilibrium for the closed-loop system with a region of attraction associated with $\{x \mid \|x\|_{R_A}^2 \leq 1\}$ of at least $\{x \mid \exists \theta \in \Theta, x^\top P(\theta) x \leq \alpha(\theta)\}$.

All \star are to be induced by symmetry. The proof of this Theorem is similar to and along the same lines as the proof of Theorem 1 in Slupphaug and Foss (1999), the main differences being that we have a parameter dependent Lyapunov function and \mathcal{S} -procedure variables, and use multi-convexity arguments (Gahinet, Apkarian and Chilali, 1996). The proof is essentially the same as the proof of Theorem 3.1 in Slupphaug et al. (2000), but there $A^l(\theta_k; K^l)$ and $c^l(\theta_k; K^l)$ were also allowed to depend on θ_k quadratically.

Proof. By Definition 2.1, the origin is an affinely quadratically stable equilibrium for the closed loop if $\exists M > 0$, $\{P_j\}_{j=0}^{N_\theta}$ and $\{K^l\}_{l=1}^N$, such that $\forall l \in I_{N^o}, x_k \in X_l, \theta_k, \theta_{k+1} \in \Theta$

$$\left\{ A^l(\theta_k; K^l) x_k \right\}^\top P(\theta_{k+1}) \star -x_k^\top P(\theta_k) x_k \leq -x_k^\top M x_k \quad (2.17)$$

$\forall l \in \{N^o + 1, \dots, N\}, x_k \in X_l, \theta_k, \theta_{k+1} \in \Theta$

$$\begin{aligned} & \left\{ \begin{bmatrix} A^l(\theta_k; K^l) & c^l(\theta_k; K^l) \end{bmatrix} \begin{bmatrix} x_k \\ 1 \end{bmatrix} \right\}^\top P(\theta_{k+1}) \star \\ & - \begin{bmatrix} x_k \\ 1 \end{bmatrix}^\top \begin{bmatrix} P(\theta_k) & 0 \\ 0 & 0 \end{bmatrix} \begin{bmatrix} x_k \\ 1 \end{bmatrix} \leq - \begin{bmatrix} x_k \\ 1 \end{bmatrix}^\top \begin{bmatrix} M & 0 \\ 0 & 0 \end{bmatrix} \begin{bmatrix} x_k \\ 1 \end{bmatrix} \end{aligned} \quad (2.18)$$

and $\forall \theta_k \in \Theta$

$$P(\theta_k) > 0. \quad (2.19)$$

Next, by using the \mathcal{S} -procedure to cover the different X_l s (see Slupphaug (1998) for details, we here extend the \mathcal{S} -procedure in a natural way by using parameter dependent \mathcal{S} -procedure variables), we get that (2.17)-(2.19) are implied by $\exists M > 0$, $\{P_j\}_{j=0}^{N_\theta}$, $\left\{ \left\{ W_j^l \right\}_{j=0}^{N_\theta} \right\}_{l=0}^{N^p}$, $\left\{ \left\{ \tau_j^l \right\}_{j=0}^{N_\theta} \right\}_{l=N^p+1}^N$ and $\{K^l\}_{l=1}^N$, such that $\forall l \in I_{N^o}, a \in \mathbb{R}^n, \theta_k, \theta_{k+1} \in \Theta$

$$\left\{ A^l(\theta_k; K^l) a \right\}^\top P(\theta_{k+1}) \star -a^\top P(\theta_k) a + a^\top M a + a^\top E_l^\top W^l(\theta_k) E_l a \leq 0$$

$\forall l \in \{N^o + 1, \dots, N^p\}, a \in \mathbb{R}^n, \theta_k, \theta_{k+1} \in \Theta$

$$\begin{aligned} & \left\{ \begin{bmatrix} A^l(\theta_k; K^l) & c^l(\theta_k; K^l) \end{bmatrix} \begin{bmatrix} a \\ 1 \end{bmatrix} \right\}^\top P(\theta_{k+1}) \star \\ & - \begin{bmatrix} a \\ 1 \end{bmatrix}^\top \begin{bmatrix} P(\theta_k) & 0 \\ 0 & 0 \end{bmatrix} \begin{bmatrix} a \\ 1 \end{bmatrix} + \begin{bmatrix} a \\ 1 \end{bmatrix}^\top \begin{bmatrix} M & 0 \\ 0 & 0 \end{bmatrix} \begin{bmatrix} a \\ 1 \end{bmatrix} \\ & + \begin{bmatrix} a \\ 1 \end{bmatrix}^\top \begin{bmatrix} E_l^\top \\ e_l^\top \end{bmatrix} W^l(\theta_k) \begin{bmatrix} E_l & e_l \end{bmatrix} \begin{bmatrix} a \\ 1 \end{bmatrix} \leq 0 \end{aligned}$$

and $\forall l \in \{N^p + 1, \dots, N\}, a \in \mathbb{R}^n, \theta_k, \theta_{k+1} \in \Theta$

$$\begin{aligned} & \left\{ \begin{bmatrix} A^l(\theta_k; K^l) & c^l(\theta_k; K^l) \end{bmatrix} \begin{bmatrix} a \\ 1 \end{bmatrix} \right\}^\top P(\theta_{k+1}) \star \\ & - \begin{bmatrix} a \\ 1 \end{bmatrix}^\top \begin{bmatrix} P(\theta_k) & 0 \\ 0 & 0 \end{bmatrix} \begin{bmatrix} a \\ 1 \end{bmatrix} + \begin{bmatrix} a \\ 1 \end{bmatrix}^\top \begin{bmatrix} M & 0 \\ 0 & 0 \end{bmatrix} \begin{bmatrix} a \\ 1 \end{bmatrix} \\ & - \tau^l(\theta_k) \begin{bmatrix} a \\ 1 \end{bmatrix}^\top \begin{bmatrix} E_l & e_l \\ e_l & \epsilon_l \end{bmatrix} \begin{bmatrix} a \\ 1 \end{bmatrix} \leq 0 \end{aligned}$$

$\forall \theta_k \in \Theta$

$$P(\theta_k) > 0$$

$\forall l \in I_{N^p}, \theta_k \in \Theta$

$$W^l(\theta_k) \in \mathbb{R}_+^{n_{E_l} \times n_{E_l}}$$

and $\forall l \in \{N^p + 1, \dots, N\}, \theta_k \in \Theta$

$$\tau^l(\theta_k) \geq 0.$$

Using the fact that $[z^\top \ 1] Q [z^\top \ 1]^\top \geq 0 \forall z \Leftrightarrow Q \geq 0$, this is equivalent to $\exists M > 0, \{P_j\}_{j=0}^{N_\theta}, \left\{ \left\{ W_j^l \right\}_{j=0}^{N_\theta} \right\}_{l=1}^{N^p}, \left\{ \left\{ \tau_j^l \right\}_{j=0}^{N_\theta} \right\}_{l=N^p+1}^N$ and $\{K^l\}_{l=1}^N$, such that $\forall l \in I_{N^o}, \theta_k, \theta_{k+1} \in \Theta$

$$\left(A^l(\theta_k; K^l) \right)^\top P(\theta_{k+1}) \star - P(\theta_k) + M + E_l^\top W^l(\theta_k) E_l \leq 0 \quad (2.20)$$

$\forall l \in \{N^o + 1, \dots, N^p\}, \theta_k, \theta_{k+1} \in \Theta$

$$\begin{aligned} & \left[A^l(\theta_k; K^l) \quad c^l(\theta_k; K^l) \right]^\top P(\theta_{k+1}) \star \\ & - \begin{bmatrix} P(\theta_k) & 0 \\ 0 & 0 \end{bmatrix} + \begin{bmatrix} M & 0 \\ 0 & 0 \end{bmatrix} + \begin{bmatrix} E_l^\top \\ e_l^\top \end{bmatrix} W^l(\theta_k) \begin{bmatrix} E_l & e_l \end{bmatrix} \leq 0 \end{aligned} \quad (2.21)$$

and $\forall l \in \{N^p + 1, \dots, N\}, \theta_k, \theta_{k+1} \in \Theta$

$$\begin{aligned} & \left[A^l(\theta_k; K^l) \quad c^l(\theta_k; K^l) \right]^\top P(\theta_{k+1}) \star \\ & - \begin{bmatrix} P(\theta_k) & 0 \\ 0 & 0 \end{bmatrix} + \begin{bmatrix} M & 0 \\ 0 & 0 \end{bmatrix} - \tau^l(\theta_k) \begin{bmatrix} E_l & e_l \\ e_l & \epsilon_l \end{bmatrix} \leq 0 \end{aligned} \quad (2.22)$$

and $\forall \theta_k \in \Theta$

$$P(\theta_k) > 0$$

$\forall l \in I_{N^p}, \theta_k \in \Theta$

$$W^l(\theta_k) \in \mathbb{R}_+^{n_{E_l} \times n_{E_l}}$$

and $\forall l \in \{N^p + 1, \dots, N\}, \theta_k \in \Theta$

$$\tau^l(\theta_k) \geq 0.$$

By applying Schur complements on equations (2.20)-(2.22) (note that necessarily $\tau^l(\theta_k) > 0$ since $P(\theta_k) > 0$ and $\epsilon_l > 0$), introducing a new symmetric matrix variable S , and noting that (see Horn and Johnson (1991,

Corollary 7.7.4)) $0 < S \leq P(\theta_{k+1})^{-1} \Leftrightarrow 0 < P(\theta_{k+1}) \leq S^{-1}$, this is equivalent to $\exists M > 0, \{P_j\}_{j=0}^{N_\theta}, S, \left\{ \left\{ W_j^l \right\}_{j=0}^{N_\theta} \right\}_{l=1}^{N^p}, \left\{ \left\{ \tau_j^l \right\}_{j=0}^{N_\theta} \right\}_{l=N^p+1}^N$ and $\{K^l\}_{l=1}^N$ such that $\forall l \in I_{N^o}, \theta \in \Theta^3$

$$\begin{bmatrix} S & A^l(\theta_k; K^l) \\ \star & P(\theta) - M - E_l^\top W^l(\theta) E_l \end{bmatrix} \geq 0 \quad (2.23)$$

$\forall l \in \{N^o + 1, \dots, N^p\}, \theta \in \Theta$

$$\begin{bmatrix} S & A^l(\theta; K^l) & c^l(\theta; K^l) \\ \star & P(\theta) - M - E_l^\top W^l(\theta) E_l & -E_l^\top W^l(\theta) e_l \\ \star & \star & -e_l^\top W^l(\theta) e_l \end{bmatrix} \geq 0 \quad (2.24)$$

$\forall l \in \{N^p + 1, \dots, N\}, \theta \in \Theta$

$$\begin{bmatrix} S & A^l(\theta; K^l) & c^l(\theta; K^l) \\ \star & P(\theta) - M + \tau^l(\theta) E_l & \tau^l(\theta) e_l \\ \star & \star & \tau^l(\theta) \epsilon_l \end{bmatrix} \geq 0 \quad (2.25)$$

$\forall \theta \in \Theta$

$$0 < P(\theta) \leq S^{-1} \quad (2.26)$$

and that $\forall l \in I_{N^p}, \theta \in \Theta$

$$W^l(\theta) \in \mathbb{R}_+^{n_{E_l} \times n_{E_l}}. \quad (2.27)$$

Now, all these matrix inequalities are parameterized in the continuous set Θ . To get a finite number of matrix inequalities, we find conditions that allow us to replace Θ with the finite set Θ_0 . One such condition is that the matrix inequalities are *multi-convex*⁴ in the parameters (Gahinet et al., 1996, Lemma 3.1), (Apkarian and Tuan, 2000a). Multi-convex essentially means “convex in each of the parameters” in our case, where Θ is a hyper-rectangle.

If the matrix inequalities are affine in the parameters, then they are always multi-convex, meaning that we can replace Θ with Θ_0 without conservatism, and the first part of the theorem follows.

The last part follows from Slupphaug and Foss (1999) and a similar argument (based on affinity in the parameters and multi-convexity) as above.

■

³Since the equations containing both θ_k and θ_{k+1} now become decoupled, we replace $\theta_k \in \Theta$ and $\theta_{k+1} \in \Theta$ with $\theta \in \Theta$. It is also noteworthy that this is the step where one loses the possibility to exploit explicitly given bounds on the parameters' rate-of-variation.

⁴Here, we need that the matrix inequalities are *multi-concave*. The conditions for this are obtained by reversing the signs in the conditions for multi-convexity.

In the state feedback synthesis result of Slupphaug et al. (2000), the affine difference inclusion in local model validity set l was on the form

$$x_{k+1} = \tilde{A}^l(\theta_k)x_k + \tilde{B}^l(\theta_k)u_k + \tilde{c}^l(\theta_k)$$

with the affine state feedback

$$u_k = \tilde{K}^l x_k + \tilde{k}^l,$$

and $A^l(\theta; K^l)$ and $c^l(\theta; K^l)$ becomes

$$\begin{aligned} A^l(\theta; K^l) &= \tilde{A}^l(\theta) + \tilde{B}^l(\theta)\tilde{K}^l \\ c^l(\theta; K^l) &= \tilde{B}^l(\theta)\tilde{k}^l + \tilde{c}^l(\theta), \end{aligned}$$

with $K^l = \{\tilde{K}^l, \tilde{k}^l\}$.

The reduced order output feedback synthesis matrices in Slupphaug et al. (2000) are more involved (also due to the fact that when we have only output information, we cannot in general be sure which local model validity set the state is in, see Section 3.3), and are omitted.

With the exception of (2.13), the inequalities in Theorem 2.1 are LMIs, which means they are convex. However, (2.13) introduces non-convexity, but this non-convex part has much smaller dimension than the convex part, which can be exploited when developing solvers. A global solver for this type of inequalities (BMIs) is developed in Tuan, Apkarian, Hosoe and Tuy (2000), and implemented in Slupphaug (1998) on a very similar synthesis problem as herein. However, solving a non-convex optimization problem globally rapidly becomes intractable as the number of optimization variables increases, which is why in many cases, resorting to local solvers is the only viable choice.

Some (local and global) solvers reported in the literature, are El Ghaoui and Balakrishnan (1994), Goh, Safonov and Papavassilopoulos (1994), El Ghaoui et al. (1997), Tuan et al. (2000), Apkarian and Tuan (2000b), Fares et al. (2001). Here we present an adaption of the solver in Fares et al. (2001) to the synthesis inequalities given in Theorem 2.1.

2.4 Solving the bilinear matrix inequalities

The non-convex synthesis problem presented herein is very similar in structure to the problem of rank minimization subject to LMI (convex) constraints, which has received substantial attention the last few years. There are reported both local and global solvers to this problem (see e.g. Apkarian and Tuan (2000b) and the references therein), and most of them have

in common that they are based on efficient algorithms for solving semidefinite programming (SDP) problems (for instance, Nesterov and Nemirovskii (1994)).

The local solver we will utilize, is a slightly modified version of the one presented in Fares et al. (2001). The optimization problems therein are on the form

$$\begin{aligned} \min & \gamma \\ \text{s.t.} & P = Q^{-1} \\ & x \in \mathcal{X}_{LMI} \end{aligned} \quad (2.28)$$

where $x = (\gamma, P, Q)$ and $x \in \mathcal{X}_{LMI}$ mean that x should satisfy some LMI constraints involving x (that is, \mathcal{X}_{LMI} is convex). These optimization problems occurs in e.g. fixed order H_∞ -synthesis, various robust quadratic performance problems, and gain-scheduling, see e.g. Gahinet and Apkarian (1994), Scherer (2001). A non-exhaustive list is provided in Apkarian and Tuan (1999).

The non-convex part of the synthesis inequalities presented herein, is on the form

$$\forall \theta \in \Theta, \quad 0 < P(\theta) \leq S^{-1}, \quad (2.29)$$

which is similar to (2.28). Since P is affine in θ , this is equivalent to

$$\hat{P} := \begin{bmatrix} P(\theta_1) & & \\ & \ddots & \\ & & P(\theta_{2N_\theta}) \end{bmatrix} \leq \begin{bmatrix} S & & \\ & \ddots & \\ & & S \end{bmatrix}^{-1} =: \hat{S}^{-1}$$

where $\theta_1, \dots, \theta_{2N_\theta}$ are the ‘‘corners’’ of the hyper-rectangle Θ . This can be made an equality constraint by adding a ‘‘slack’’-variable⁵ $\Delta \geq 0$,

$$\hat{P} + \Delta = \hat{S}^{-1}.$$

Having established this, we can adapt the method in Fares et al. (2001). They call this method sequential semi-definite programming (SSDP), and it enjoys many similarities with sequential quadratic programming (SQP), see e.g. Nocedal and Wright (1999). The key idea is to form an augmented Lagrangian function for the BMI problem in Theorem 2.1:

$$\begin{aligned} \Phi_c(x, \Lambda) &= \gamma + \sum_{ij} \Lambda_{ji} ((\hat{P} + \Delta)\hat{S} - I)_{ij} + \frac{c}{2} \sum_{ij} ((\hat{P} + \Delta)\hat{S} - I)_{ij}^2 \\ &= \gamma + \text{tr} \Lambda ((\hat{P} + \Delta)\hat{S} - I) + \frac{c}{2} \text{tr} \left[((\hat{P} + \Delta)\hat{S} - I)^\top ((\hat{P} + \Delta)\hat{S} - I) \right] \end{aligned}$$

⁵ Δ should be taken as block-diagonal, with the same structure as \hat{P} .

and minimizing this function with respect to $x = (\hat{P}, \hat{S}, \Delta, \gamma)$ subject to $x \in \mathcal{X}_{LMI}$. Here, \mathcal{X}_{LMI} is the convex set given by the LMI constraints specified in Theorem 2.1. The minimization is done by sequentially approximating the augmented Lagrangian function by a second-order Taylor expansion and minimizing this by solving an SDP-problem in x , while updating the Lagrange multiplier Λ and the penalty parameter c in a “smart” way at each iteration.

At each step $x^{(i)}$, the next step $x^{(i+1)}$ is found by use of a (backtracking) line search method (see e.g. Nocedal and Wright (1999)),

$$x^{(i+1)} = x^{(i)} + \alpha p^{(i)}$$

where $\alpha \in [0, 1]$ is a scalar step-size, and $p^{(i)}$ is the search direction at iteration i . The search direction is found from the following SDP problem, corresponding to a minimization of a quadratic approximation of Φ_c at $x^{(i)}$:

$$\begin{aligned} & \min t \\ & \text{s.t.} \quad \begin{bmatrix} t - \nabla \Phi_{c^{(i)}}(x^{(i)}, \Lambda^{(i)})^\top p^{(i)} & (p^{(i)})^\top \\ p^{(i)} & (\nabla^2 \Phi_{c^{(i)}}(x^{(i)}, \Lambda^{(i)}))^{-1} \end{bmatrix} \geq 0 \\ & \quad x^{(i)} + p^{(i)} \in \mathcal{X}_{LMI}. \end{aligned}$$

Note that since \mathcal{X}_{LMI} is convex, $x^{(i+1)} \in \mathcal{X}_{LMI}$ since $x^{(i)} \in \mathcal{X}_{LMI}$, $x^{(i)} + p^{(i)} \in \mathcal{X}_{LMI}$ and $\alpha \in [0, 1]$. The expressions for the gradient and Hessian are developed similarly to Fares et al. (2001), see Appendix A.

The SSDP method has good convergence properties. For a discussion of these, we refer to Fares et al. (2001).

2.5 Discussion and some concluding remarks

Synthesis inequalities for synthesizing controller structures (which typically are piecewise affine) for affine quadratic stability of systems described by piecewise affine difference inclusions are given. In addition to making the closed loop robust for the modeled uncertainties, the synthesis procedure can take constraints into consideration by adding some extra LMIs. This can be done as in Slupphaug (1998), Slupphaug et al. (2000), and will be used in the next chapter.

The proposed synthesis method has some drawbacks related to conservativeness. Firstly, the uncertainty description might be conservative (take non-existing dynamics into account). However, the representation allows for tighter bounds than linear (or piecewise linear) uncertainty descriptions.

But the main drawback is that the approach relies on finding a common quadratic Lyapunov function that decreases in all local model validity sets. That is, the procedure does not exploit the fact that the dynamics on these known sets might be significantly different. Methods that do take this into account exist, see for example Johansson (1999) in the analysis case, and Rantzer and Johansson (2000), Ferrari-Trecate, Cuzzola, Mignone and Morari (2001) in a control setting. These control approaches do, however, only consider piecewise *linear* state feedback.

In addition to this comes the non-convexity of the resulting synthesis inequalities, which also can lead to conservativeness since a solution might not be found, even when one exists.

A solver for the synthesis bilinear matrix inequalities is given, as an adaption of a solver presented in Fares et al. (2001). The solver is of second order, which means that it uses the (exact) Hessian of the augmented Lagrangian function. Our experience is that the solver behaves well when starting reasonably close to an optimum and that it finds solutions to some problems where first-order solvers fail. A first-order solver based on Apkarian and Tuan (2000b) is used for providing a good starting point for the second-order solver. This concave-programming based gradient-algorithm converges quickly (often only one iteration is required) to a solution relatively close to an optimum, but it requires a large number of extra LMI-variables. As is common for gradient-methods, it is prone to zigzagging when approaching the optimum.

Chapter 3

Robust Output Feedback Using Piecewise Affine Observers and Controllers

The synthesis result presented in Chapter 2 is used to develop synthesis inequalities for a piecewise affine observer-based controller structure. Two approaches are presented: First, a rather direct application is given as a combined synthesis of controller and observer. Second, a separated approach is adopted to split the synthesis problem into two smaller synthesis problems. It is shown that the separated approach can handle a larger system class.

A large part of the contents is based on Imsland et al. (2001c,d). An early version of the content in Section 3.4 was presented in Imsland et al. (2001e).

3.1 Introduction

A common approach to the output feedback stabilization problem is to design an observer to obtain an estimate of the state, and then (independently) design a state feedback controller using the estimated state. This *certainty equivalence* approach, using an estimate of the state instead of the real state, is a successful approach in the case of linear systems. This follows since using linear state feedback coupled with a linear state observer results in global asymptotic closed-loop stability as long as the observer-error dynamics and the closed-loop process under pure state feedback are asymptotically stable. In this case the *separation principle* is said to hold (Khalil, 1996), since the assignment of the closed loop eigenvalues can be carried out as separate tasks

for the state feedback and observer problems.

For nonlinear systems, it is possible to establish separation principles that either gives (only) local stability (see e.g. Scokaert, Rawlings and Meadows (1997)), or obtains regional results for specific classes of systems. As an example, Atassi and Khalil (1999) shows that the performance (including asymptotic stability and region of attraction) of a globally bounded state feedback control of a certain class of nonlinear systems can be recovered using a sufficiently fast high-gain observer. Despite this, the lack of a global separation principle for general nonlinear systems suggests that designing state feedback for use with a state observer for a nonlinear system, should not be done independently, but one should analyze the nonlinear system with the (nonlinear) observer as one system.

In Slupphaug et al. (2000), the authors approached the output feedback problem using a (reduced order) piecewise affine *static* output feedback (and, by augmenting the state, also *dynamic* output feedback) for constrained nonlinear discrete-time systems. The associated bilinear matrix inequality feasibility problem has proved hard to solve, thus motivating us to consider an observer-based controller structure - more specifically, a piecewise affine observer-based controller structure. Besides the well-proven success of observer-based output feedback, an additional motivation is that structuring the dynamic part of the controller this way, can be viewed as limiting the controller parameter search-space in comparison to the approach in Slupphaug et al. (2000).

A similar approach as the one herein is presented in Rodrigues and How (2001), where observer-based control of piecewise affine continuous time systems is considered. However, constraints and robustness to model uncertainty are not directly considered therein. The approach taken to solve the resulting BMIs is the so-called *V-K* algorithm, which essentially splits the non-convex optimization problem into two convex parts, and iterates between the two.

The (first) approach taken herein is to *simultaneously* search for a piecewise affine observer-state feedback and a piecewise affine observer output injection that stabilize the composite system, taking constraints into consideration. For a general class of uncertain nonlinear discrete-time systems and a general class of observers (Section 3.2), Section 3.3 develops synthesis matrix inequalities (based on Theorem 2.1) whose solution gives gain matrices used in the controller and the observer. The resulting matrix inequalities in this *combined synthesis* are rather complex, hence it is shown in Section 3.4 how to split the synthesis problem into one state-feedback and one observer synthesis problem. This *separated synthesis* reduces the overall complexity considerably. As could be expected, a straightforward separation gives

only local stability guarantees. It is shown that by using information from the state feedback synthesis in the observer synthesis, regional closed loop stability is obtained.

In Section 3.5 the approach is illustrated with a simple example. A slightly more realistic example is also included, to illustrate further features of the output feedback structure.

In the following, variables with superscript s (or no superscript) are associated with the description of the nonlinear system to control. Variables with “hat” or superscript o are tied to the observer.

3.2 System and observer models

We will consider quite general nonlinear state space models and observer models, that will be represented by a piecewise affine difference inclusion in order to fit the synthesis framework to be presented later.

3.2.1 System class and piecewise affine encapsulation

The system to control is a discrete time uncertain nonlinear system with an uncertain output mapping, described by

$$x_{k+1} \in \mathcal{F}(x_k, u_k, \Psi) \subset \mathbb{R}^n \quad (3.1)$$

$$y_k \in \mathcal{G}(x_k, \Psi) \subset \mathbb{R}^r, \quad (3.2)$$

where

$$\begin{aligned} \mathcal{F}(x, u, \Psi) &:= \{x^+ | x^+ = f(x, u, \psi) \text{ for some } \psi \in \Psi\} \\ \mathcal{G}(x, \Psi) &:= \{y | y = h(x, \psi) \text{ for some } \psi \in \Psi\}. \end{aligned}$$

We will assume that the system is constrained, that is, the allowed values for the inputs and states are $u_k \in U \subset \mathbb{R}^m$ and $x_k \in X \subset \mathbb{R}^n$, respectively. We will also call these sets the *model validity sets*, and they contain the origin in their interiors. We assume that $f(0, 0, \cdot) = 0$ and $h(0, \cdot) = 0$, thus the equilibrium input is assumed known. This, in principle, excludes systems for which integral control is needed, but by way of example, we will see that integral-like controllers in some situations still can be synthesized with this procedure.

The above system class is large, but will be restricted by the class of uncertainty models that will be used. However, it should be noted that discontinuities are allowed except at the origin, where both f and h should be Lipschitz continuous. We will assume that the dynamics of this uncertain

system can be encapsulated by a difference inclusion of local affine models, i.e.

$$\mathcal{F}(x, u, \Psi) \subset \mathcal{M}_{i(x)}(x, u, \Theta^s), \quad \forall x \in X, u \in U \quad (3.3)$$

$$\mathcal{G}(x, \Psi) \subset \mathcal{H}_{i(x)}(x, \Theta^s), \quad \forall x \in X. \quad (3.4)$$

Here, $i(x) := \{i \in I_{N_L} \mid x \in X_i^L\}$ with $I_N := \{1, \dots, N\}$. The set X_i^L is *local model validity set* i , which is the part of the state-space in which uncertainty model i is valid. The local model validity sets will without loss of generality be taken as non-overlapping (hence $i(x)$ is a singleton). Further, they shall exactly cover X , i.e. $X = \cup_{i \in I_{N_L}} X_i^L$, where N_L is the total number of local uncertainty models (and associated validity sets). The \mathcal{M}_i s and \mathcal{H}_i s are defined by

$$\mathcal{M}_i(x, u, \Theta^s) := \{x^+ \mid \exists \theta \in \Theta^s, x^+ = A^i(\theta)x + B^i(\theta)u + c^i(\theta)\} \quad (3.5)$$

$$\mathcal{H}_i(x, \Theta^s) := \{y \mid \exists \theta \in \Theta^s, y = C^i(\theta)x + d^i(\theta)\}, \quad (3.6)$$

where the involved matrices are affine in the parameter θ , i.e. $A^i(\theta) := A_0^i + \sum_{j=1}^{N_\theta^s} A_j^i \theta_j$, and analogously for $B^i(\theta)$, $c^i(\theta)$, $C^i(\theta)$ and $d^i(\theta)$. The parameter i denotes in which subset (*local model validity set*) of the state-space the matrices are valid. Further, $\theta = (\theta_1, \dots, \theta_{N_\theta^s})^\top \in \Theta^s$ is the possibly time-varying parameter vector and N_θ^s is the number of parameters. The parameter vector is assumed to be in a hyper-rectangle

$$\Theta^s := \left\{ \theta = (\theta_1, \dots, \theta_{N_\theta^s})^\top \mid \forall j \in I_{N_\theta^s}, \theta_j \in [0, 1] \right\}.$$

A procedure for obtaining this uncertainty description from a given non-linear ODE with uncertain parameters is given in Slupphaug et al. (2000). If the uncertainty description is obtained by upper and lower bounding each element of the uncertain state transition map, \mathcal{F} , and output mapping, \mathcal{G} , see Figure 3.1, then typically the number of parameters is $N_\theta^s = n + r$, i.e., the dimension of the state and output vector. But note that if some elements of \mathcal{F} or \mathcal{G} are linear, N_θ^s will be smaller, as will be illustrated in the examples.

For the $N_{L0} \leq N_L$ local model validity sets that contain the origin in their closure, the ‘‘affine terms’’ ($c^i(\theta)$ and $d^i(\theta)$) are identically zero. This ensures a well defined equilibrium at the origin, and is possible since it is assumed that $f(0, 0, \psi) = 0$ and $h(0, \psi) = 0$ for all $\psi \in \Psi$.

We also define non-overlapping *local output sets*, Y_j^L , $j \in I_{M_L}$. These partition the output space Y , and are used for defining the piecewise affine observer output injection structure. By assuming that output constraints

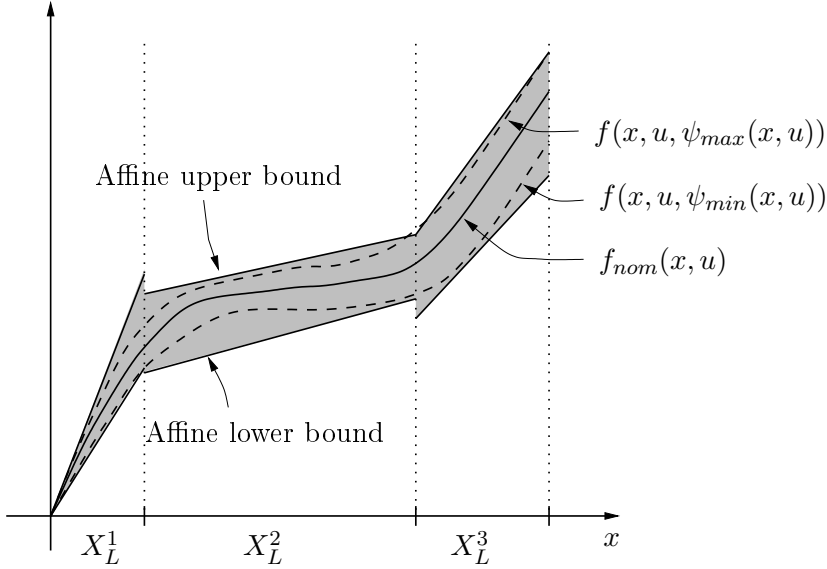

Figure 3.1: Illustration of the uncertainty modeling. The shaded area is accounted for in the controller synthesis. ψ_{max} and ψ_{min} should be taken as the “extreme” values of the uncertainty parameter, i.e something like $\psi_{max}(x, u) = \arg \max_{\psi \in \Psi} f(x, u, \psi)$.

are mapped to the state space, there is no loss of generality in constructing $Y = \cup_{j \in I_{M_L}} Y_j^L = \mathbb{R}^r$. This automatically ensures that the piecewise affine observer output injection to be constructed is well defined. Also define $M_{L0} \leq M_L$, the number of local output sets with the origin in their closure.

3.2.2 Observer class and piecewise affine encapsulation or representation

We assume a full state model-based observer with an “observer correction term” v_k ,

$$\begin{aligned}\hat{x}_{k+1} &= f^o(\hat{x}_k, u_k) + v_k \\ \hat{y}_k &= g^o(\hat{x}_k),\end{aligned}$$

defined for $\hat{x}_k \in \hat{X} \subset \mathbb{R}^n$, $u_k \in U$ and $v_k \in \mathbb{R}^n$. A natural choice for the observer model is a nominal nonlinear model of the system to be controlled, e.g. $f^o(x, u) = f(x, u, \psi_{nom})$ and $g^o(x) = g(x, \psi_{nom})$ where ψ_{nom} is a nominal value of the uncertain parameter vector ψ , since a small model error is a good basis for observer design. It should be noted, however, that there is

no assumption that requires the observer model to be within $\mathcal{F}(x, u, \Psi)$ and $\mathcal{G}(x, \Psi)$.

To develop the synthesis inequalities, we need to represent the dynamics of the observer using local affine parameter-varying models. This can be done by encapsulating the dynamics (as done for the nonlinear system equations above) by an affine difference inclusion

$$\begin{aligned} f^o(\hat{x}, u) &\in \hat{\mathcal{M}}_{\hat{i}(\hat{x})}(\hat{x}, u, \Theta^o), \quad \forall \hat{x} \in \hat{X}, u \in U \\ g^o(\hat{x}) &\in \hat{\mathcal{H}}_{\hat{i}(\hat{x})}(\hat{x}, \Theta^o), \quad \forall \hat{x} \in \hat{X}. \end{aligned}$$

The $\hat{i}(\hat{x})$, $I_{N_L^o}$, \hat{X}_i^L , $\hat{A}^i(\theta)$, Θ^o etc. should be defined as for the system, see section 3.2.1.

By encapsulating the nonlinear dynamics of the observer using this difference inclusion, we implicitly take into consideration “non-existing” observer dynamics (since we in principle know the observer dynamics exactly). Depending on how many local model validity sets we choose to use, and how close the encapsulation is, this will introduce a varying degree of conservatism and complexity (i.e, synthesis problem size).

If we choose a piecewise affine observer model,

$$\begin{aligned} f^o(\hat{x}, u) &= \hat{A}^{\hat{i}(\hat{x})}\hat{x} + \hat{B}^{\hat{i}(\hat{x})}u + \hat{c}^{\hat{i}(\hat{x})} \\ g^o(\hat{x}) &= \hat{C}^{\hat{i}(\hat{x})}\hat{x} + \hat{d}^{\hat{i}(\hat{x})} \end{aligned}$$

we can account for the exact observer dynamics, and the resulting complexity will be significantly reduced. This observer model can for instance be obtained by an piecewise affine approximation of a nominal model. Note that an approximation can be made arbitrarily accurate by using many local model validity sets. This observer model can be viewed as the special case of the above with $N_\theta^o = 0$.

3.3 Output feedback controller synthesis

Based on the models above, we will develop synthesis inequalities parameterized by matrices defining a piecewise affine observer-state feedback and an observer output injection. Feasibility of the inequalities will imply that the feedback and observer correction structure will exponentially stabilize the given uncertainty class for the defined uncertainties.

Let $j(y) := \{j \in I_{M_L} | y \in Y_j^L\}$. When the dependence on the arguments is understood from the context, we will write i , \hat{i} and j for $i(x)$, $\hat{i}(\hat{x})$ and $j(y)$, respectively.

3.3.1 Feedback and observer injection structure

The control u_k and observer correction term v_k are chosen to be affine functions of the observer state \hat{x}_k and the system and observer output y_k and \hat{y}_k ,

$$u_k = K_s^{\hat{i}} \hat{x}_k + k_s^{\hat{i}} \quad (3.7)$$

$$v_k = K_o^j (y_k - \hat{y}_k) + k_o^j \quad (3.8)$$

The feedback matrices ($K_s^{\hat{i}}$ and $k_s^{\hat{i}}$) are chosen based on which subset \hat{X}_i^L the observer state \hat{x}_k is in (hence superscript $\hat{i} = \hat{i}(\hat{x}_k)$). The observer matrices can be based on which of the local output sets Y_j^L , $j \in I_{ML}$, the output y_k is in, or by choosing them based on which subset \hat{X}_i^L , $\hat{i} \in I_{NL}$ the observer state \hat{x}_k is in (i.e. replace j with \hat{i}). The latter approach can be seen as the most natural, and will, as will be seen, typically simplify the procedure of constructing the synthesis inequalities considerably. Nevertheless, the synthesis inequalities will be presented using the former approach, since this is the most general, and to keep notational compatibility with Slupphaug et al. (2000).

For the \hat{X}_i^L s and the Y_j^L s containing the origin in their closure, $k_s^{\hat{i}}$ and k_o^j (or $k_o^{\hat{i}}$) are zero.

Note that other feedback/observer structures that are affine in y_k , \hat{x}_k and \hat{y}_k can be chosen, and will result in similarly structured matrix inequalities.

3.3.2 Closed-loop dynamics

To guarantee closed-loop stability, we need to consider the closed-loop dynamics consisting of both the real state and the observer state, or equivalently, the real state and the observer error.

Inserting the feedback and observer correction terms into the affine parameter-dependent ‘‘open-loop’’ equations describing the system and the observer, we obtain the closed-loop dynamics, for $x_k \in X_i^L$, $\hat{x}_k \in \hat{X}_i^L$ and $y_k \in Y_j^L$, and for some $\theta_k^s \in \Theta^s$ and $\theta_k^o \in \Theta^o$,

$$\begin{bmatrix} x_{k+1} \\ \hat{x}_{k+1} \end{bmatrix} = A \left(K_s^{\hat{i}}, K_o^j; \theta_k \right) \begin{bmatrix} x_k \\ \hat{x}_k \end{bmatrix} + c \left(k_s^{\hat{i}}, K_o^j, k_o^j; \theta_k \right) \quad (3.9)$$

with

$$\begin{aligned}
 \theta_k &:= [(\theta_k^s)^\top \quad (\theta_k^o)^\top]^\top \\
 \mathbf{A} \left(K_s^i, K_o^j; \theta_k \right) &:= \begin{bmatrix} A^i(\theta_k^s) & 0 \\ 0 & \hat{A}^i(\theta_k^o) \end{bmatrix} + \begin{bmatrix} B^i(\theta_k^s) \\ \hat{B}^i(\theta_k^o) \end{bmatrix} K_s^i [0 \quad I] + \\
 &\quad \begin{bmatrix} 0 \\ I \end{bmatrix} K_o^j [C^i(\theta_k^s) \quad -\hat{C}^i(\theta_k^o)] \\
 \mathbf{c} \left(k_s^i, K_o^j, k_o^j; \theta_k \right) &:= \begin{bmatrix} c^i(\theta_k^s) \\ \hat{c}^i(\theta_k^o) \end{bmatrix} + \begin{bmatrix} B^i(\theta_k^s) \\ \hat{B}^i(\theta_k^o) \end{bmatrix} k_s^i + \\
 &\quad \begin{bmatrix} 0 \\ I \end{bmatrix} K_o^j \left(d^i(\theta_k^s) - \hat{d}^i(\theta_k^o) \right) + \begin{bmatrix} 0 \\ I \end{bmatrix} k_o^j.
 \end{aligned}$$

Importantly, these matrices are affine in both the uncertainty parameters, and the feedback/injection matrices. Note that the same is true for the dynamics when using the state and observer error as the composite state, since

$$\begin{bmatrix} x_k \\ \tilde{x}_k \end{bmatrix} = \begin{bmatrix} I & 0 \\ I & -I \end{bmatrix} \begin{bmatrix} x_k \\ \hat{x}_k \end{bmatrix}.$$

3.3.3 The subsets of the state-space with the same observer and feedback

For use in the stability analysis, we need to identify subsets of the total state-space where the same observer and feedback matrices are used.

We have the local model validity sets $X_i^L, i \in I_{N_L}$, the local observer model validity sets $\hat{X}_i^L, \hat{i} \in I_{N_L^o}$ and the local output sets $Y_j^L, j \in I_{M_L}$, covering the state-space, X , observer state-space, \hat{X} and output-space, Y , respectively. We will define subsets $X_{i\hat{i}j}$ on $X \times \hat{X}$ such that, loosely speaking, the closed-loop dynamics on $X_{i\hat{i}j}$ is associated with open loop dynamics \mathcal{M}_i , observer dynamics $\hat{\mathcal{M}}_{\hat{i}}$ and observer state feedback \hat{i} and observer output injection j . These subsets will be called *intersection sets*, and the union of all of them will exactly cover $X \times \hat{X}$ since Y covers all the possible outputs from X . The intersection sets may be overlapping.

Formally, the intersection sets $X_{i\hat{i}j}$ are given as

$$X_{i\hat{i}j} := \left(X_i^L \cap \left\{ x \mid \exists \theta \in \Theta^s \text{ s.t. } C^{i(x)}(\theta)x + d^{i(x)}(\theta) \in Y_j^L \right\} \right) \times \hat{X}_{\hat{i}}^L.$$

This is illustrated in Figure 3.2. Note that these intersection sets will in general not be “nice” (polytopic, or convex, or both) even if the local validity sets are “nice”. This is due to the multiplication of the states and parameters in the output model.

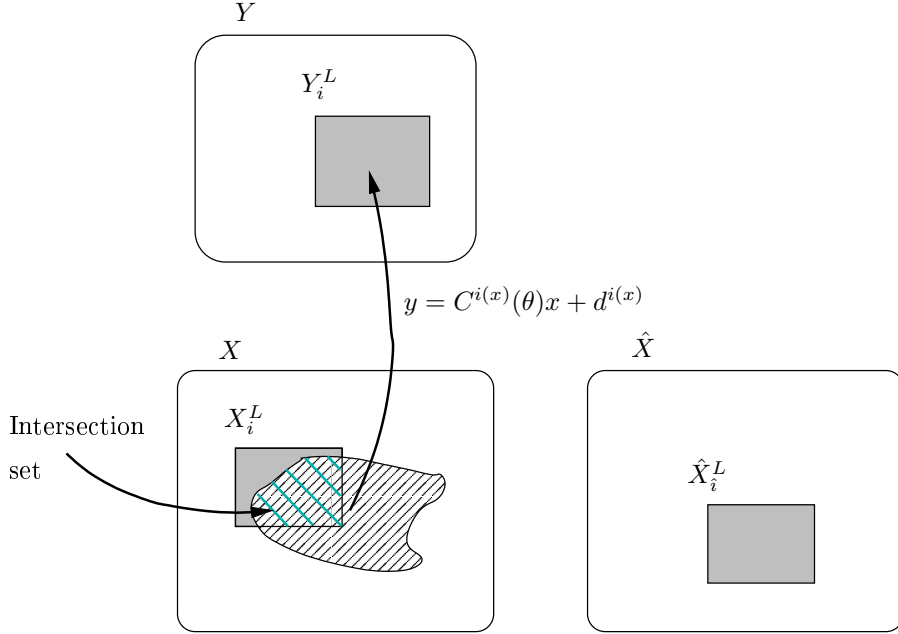

Figure 3.2: Illustration of the intersection sets

When choosing observer matrices based on the observer state instead of the output (i.e, using K_o^i, k_o^i instead of K_o^j, k_o^j), the desired subsets are no longer intersections, but simply defined as

$$X_{ii} := X_i^L \times \hat{X}_i^L,$$

which typically are much simpler to handle (X_{ii} will have the same properties as X_i^L and \hat{X}_i^L).

In the rest of this section, we will call these subsets *intersection sets* and refer to them with X_{ij} (for reasons explained above), but they can everywhere be replaced by X_{ii} . These sets will form the basis for using the \mathcal{S} -procedure when deriving the stability conditions for the closed-loop.

3.3.4 Set approximations

To represent the sets X_{ij} in an appropriate way in the synthesis inequalities to come, we need to outer approximate them with either ellipsoids or polytopes. This is done as in Slupphaug and Foss (1999), but we briefly repeat it here for completeness. The X_{ij} s containing the origin (i.e, the origin of both the state space and the observer state space) in their closure are outer

approximated by unbounded polytopes¹ $\{\xi | E_l \xi \leq 0\}$, and are indexed with $l \in I_{N^o}$, the $X_{i_l j_l}$ s *not* containing the origin in their closure are outer approximated either by possibly bounded polytopes $\{\xi | E_l \xi + e_l \leq 0\}$, and indexed in $\{N^o + 1, \dots, N^p\}$, or by ellipsoids $\{\xi | \begin{bmatrix} \xi^\top & 1 \end{bmatrix} \begin{bmatrix} E_l & e_l \\ e_l^\top & \epsilon_l \end{bmatrix} \begin{bmatrix} \xi \\ 1 \end{bmatrix} \leq 0\}$, indexed in $\{N^p + 1, \dots, N\}$. With this indexing, for each l there exists a unique triple (i, \hat{i}, j) which will be called (i_l, \hat{i}_l, j_l) , thus intersection set number l is $X_{i_l \hat{i}_l j_l}$. Note that N^o is the number of intersection sets containing the origin in their closure, while N^p is the number of intersection sets outer approximated by polytopes, and N is the total number of non-empty intersection sets.

The total state-space $X \times \hat{X}$ is *inner approximated* as follows²

$$0 \in \bigcap_{l \in I_{N_{q\xi}}} \{\xi \mid \|\xi - \xi_{l,c}\|_{H_{l,\xi}}^2 \leq 1\} \subset X \times \hat{X}, \quad (3.10)$$

i.e. by an intersection of ellipsoids where $\xi_{l,c}$ are the centers of the ellipsoids, and $N_{q\xi}$ is the number of ellipsoids. Similarly, we assume

$$0 \in \bigcap_{p \in I_{N_{qu}}} \{u \mid \|u - u_{p,c}\|_{H_{p,u}}^2 \leq 1\} \subset U, \quad (3.11)$$

where U is the control model validity- and constraint set, $u_{p,c}$ are the centers of the ellipsoids, and N_{qu} is the number of ellipsoids.

3.3.5 Combined synthesis based on quadratic stability

Our goal is to specify matrix inequalities whose feasibility imply that the origin of the closed-loop system is *affinely quadratically stable*, see Definition 2.1. Briefly, it means that a quadratic, affinely parameter-dependent, Lyapunov function $V(z) = z^\top P(\theta)z$ (z is the composite state, see below) exists, and that the region of attraction is larger than a given ellipsoid R_A . Note that the affine quadratic stability of (3.9) implies that the origin of the nonlinear system (3.1) with observer based output feedback is exponentially stable.

It is common in observer design to use the error variable $\tilde{x}_k := x_k - \hat{x}_k$ and design an observer for convergence of \tilde{x}_k , $\tilde{x}_k \rightarrow 0$ (i.e., $\hat{x}_k \rightarrow x_k$). Stability of the origin in the variables $z = \begin{bmatrix} x_k^\top & \hat{x}_k^\top \end{bmatrix}^\top$ is equivalent to stability of the origin in the variables $z = \begin{bmatrix} x_k^\top & \tilde{x}_k^\top \end{bmatrix}^\top$, since there is a (linear) non-singular

¹In this section, ξ will be denoting a variable in the combined state/observer state-space, $\xi \in X \times \hat{X}$.

² $\|x\|_H := \sqrt{x^\top H x}$, $H > 0$.

transformation between the two representations. The synthesis inequalities can be specified for both choices. Note that even though the stability analysis might be performed in the (x_k, \tilde{x}_k) -variables (i.e., the Lyapunov level sets are subsets of the (x_k, \tilde{x}_k) state-space), it is sensible to cover the subsets X_{ii} in (x_k, \hat{x}_k) -coordinates, since the models and the intersection sets typically are specified in these coordinates.

In the following result we will need the affine functions defined by

$$a(\theta) := a_o + \sum_{j=1}^{N_\theta} \theta_j a_j, \quad a \in \{P, \alpha, W^l, \tau^l, \beta, \mu^l\}.$$

The W_j^l s are symmetric matrices whose dimension are the row dimension of the corresponding E_{ls} , defined by n_{E_l} . The α_{js} , τ_j^l s, β_{js} and μ_j^l s are scalars. Further,

$$\Omega = \begin{bmatrix} I & 0 \\ 0 & I \end{bmatrix} \text{ or } \Omega = \begin{bmatrix} I & 0 \\ I & -I \end{bmatrix}$$

depending on if R_A is given in the (x_k, \hat{x}_k) -coordinates, or in the (x_k, \tilde{x}_k) -coordinates, respectively. We will use θ for θ_k , $\theta \in \Theta := \Theta^s \times \Theta^o \subset \mathbb{R}^{N_\theta}$, $N_\theta := N_\theta^s + N_\theta^o$.

Theorem 3.1 *Let Θ_0 be the corners of the parameter box Θ , i.e. $\Theta_0 = \{0, 1\}^{N_\theta}$. Then, if $\exists M > 0$, symmetric matrices $\{P_j\}_{j=0}^{N_\theta}$ and S , matrices of appropriate dimensions $\{K_s^i\}_{i=1}^{N_L^o}$, $\{k_s^i\}_{i=N_{L^o}+1}^{N_L^o}$, $\{K_o^j\}_{j=1}^{M_L}$, $\{k_o^j\}_{j=M_{L^o}+1}^{M_L}$, $\left\{ \left\{ W_j^l \right\}_{j=0}^{N_\theta} \right\}_{l=1}^{N^p}$, $\left\{ \left\{ \tau_j^l \right\}_{j=0}^{N_\theta} \right\}_{l=N^p+1}^N$ such that $\forall l \in I_{N^o}, \theta \in \Theta_0$*

$$\begin{bmatrix} S & \Omega \Lambda \left(K_s^{\hat{i}_l}, K_o^{\hat{j}_l}; \theta \right) \\ \star & \Omega^\top P(\theta) \Omega - M - E_l^\top W^l(\theta) E_l \end{bmatrix} \geq 0 \quad (3.12)$$

$\forall l \in \{N^o + 1, \dots, N^p\}, \theta \in \Theta_0$

$$\begin{bmatrix} S & \Omega \Lambda \left(K_s^{\hat{i}_l}, K_o^{\hat{j}_l}; \theta \right) & \Omega c \left(k_s^{\hat{i}_l}, K_o^{\hat{j}_l}, k_o^{\hat{j}_l}; \theta \right) \\ \star & \Omega^\top P(\theta) \Omega - M - E_l^\top W^l(\theta) E_l & -E_l^\top W^l(\theta) e_l \\ \star & \star & -e_l^\top W^l(\theta) e_l \end{bmatrix} \geq 0 \quad (3.13)$$

$\forall l \in \{N^p + 1, \dots, N\}, \theta \in \Theta_0$

$$\begin{bmatrix} S & \Omega \Lambda \left(K_s^{\hat{i}_l}, K_o^{\hat{j}_l}; \theta \right) & \Omega c \left(k_s^{\hat{i}_l}, K_o^{\hat{j}_l}, k_o^{\hat{j}_l}; \theta \right) \\ \star & \Omega^\top P(\theta) \Omega - M + \tau^l(\theta) E_l & \tau^l(\theta) e_l \\ \star & \star & \tau^l(\theta) \epsilon_l \end{bmatrix} \geq 0 \quad (3.14)$$

$$\forall \theta \in \Theta_0 \quad 0 < P(\theta) \leq S^{-1} \quad (3.15)$$

and $\forall l \in I_{N_p}, \theta \in \Theta_0$

$$W^l(\theta) \in \mathbb{R}_+^{n_{E_l} \times n_{E_l}},$$

then the origin is an affinely quadratically stable equilibrium for the closed-loop system (implied by (3.12) and (3.15)), and the Lyapunov function is decreasing everywhere in $X \times \hat{X}$. If, in addition, there exist reals $\{\alpha_j\}_{j=0}^{N_\theta}$ and $\{\beta_j\}_{j=0}^{N_\theta}$ such that $\forall \theta \in \Theta_0$

$$\begin{bmatrix} P(\theta) - \beta(\theta)R_A & 0 \\ 0 & \beta(\theta) - \alpha(\theta) \end{bmatrix} \leq 0 \quad (3.16)$$

and reals $\left\{ \left\{ \mu_j^l \right\}_{j=0}^{N_\theta} \right\}_{l \in I_{N_{q\xi}}}$ such that $\forall l \in I_{N_{q\xi}}, \theta \in \Theta_0$

$$\begin{bmatrix} \mu^l(\theta)H_{l,\xi} - \Omega^\top P(\theta)\Omega & -\mu^l(\theta)H_{l,\xi}\xi_{l,c} \\ \star & \mu^l(\theta)(\xi_{l,c}^\top H_{l,\xi}\xi_{l,c} - 1) + \alpha(\theta) \end{bmatrix} \leq 0, \quad (3.17)$$

then the origin is an affinely quadratically stable equilibrium with a region of attraction containing $\{z \mid \|z\|_{R_A}^2 \leq 1\}$ of at least $\{z \mid \exists \theta \in \Theta, z^\top P(\theta)z \leq \alpha(\theta)\}$.

All \star are to be induced by symmetry. Note that these matrix inequalities are all LMIs, with the exception of (3.15).

The proof is a special case of Theorem 2.1, noting that the model has only affine terms in θ and the matrices specifying the feedback and the observer injection, and is therefore omitted.

Theorem 3.1 considers (quadratic, regional) *stability*. However, performance can be improved by LMI (convex) optimizations after a feasible solution to the above inequalities is found. Removing S as a variable (by inserting S from the first solution), one can maximize (the smallest eigenvalue of) M , improving the speed of the closed-loop exponential convergence.

3.3.6 Input constraints

It is rather straightforward to extend Theorem 3.1 to take input constraints into consideration. This is done by inner approximating U by intersections of ellipsoids (see Section 3.3.4), and provide conditions that ensure that $u_k = K_s^i \hat{x}_k + k_s^i$ is inside these intersections. These conditions can be posed as LMIs (Slupphaug, 1998, Slupphaug et al., 2000) that can be added to the inequalities in Theorem 3.1.

We have to satisfy the control constraints, U , in all the \hat{X}_i^L s. For this to be the case, it is sufficient that $\forall(p, \hat{i}) \in I_{N_{qu}} \times I_{N_L^o}, \theta \in \Theta$

$$\left\| K_s^{\hat{i}} \hat{x} + k_s^{\hat{i}} - u_{p,c} \right\|_{H_{p,u}}^2 \leq 1, \hat{x} \in \hat{X}_i^L. \quad (3.18)$$

When outer approximating the \hat{X}_i^L s for formulating LMI conditions for satisfying control input constraints in this manner, it is only sensible to use ellipsoids (or unions of ellipsoids, not considered herein, see Slupphaug and Foss (1999)). Thus, we assume that

$$\{x \mid \begin{bmatrix} x \\ 1 \end{bmatrix}^\top \begin{bmatrix} \tilde{E}_i & \tilde{e}_i \\ \tilde{e}_i^\top & \tilde{\epsilon}_i \end{bmatrix} \begin{bmatrix} x \\ 1 \end{bmatrix} \leq 0\} \supset \hat{X}_i^L.$$

Using the \mathcal{S} -procedure and Schur complements on (3.18), we get that the LMI conditions: $\forall(p, l) \in I_{N_{qu}} \times I_N \exists \tau_{l,p}^E$

$$\begin{bmatrix} \tau_{l,p}^E \tilde{E}_i & \tau_{l,p}^E \tilde{e}_i & (K_s^{\hat{i}})^\top \\ \star & 1 + \tau_{l,p}^E \tilde{\epsilon}_i & (k_s^{\hat{i}} - u_{p,c})^\top \\ \star & \star & H_{p,u}^{-1} \end{bmatrix} \geq 0$$

$$\tau_{l,p}^E \geq 0$$

imply the sufficient condition (3.18) for satisfying control input constraints, and can be added to the LMIs in Theorem 3.1. Note that these conditions imply that the constraints are satisfied for all $\hat{x}_k \in \hat{X}$, not only the \hat{x}_k inside the resulting region of attraction.

3.3.7 Reducing conservatism

The synthesis inequalities guarantee a decreasing Lyapunov function in all the subsets X_{ij} of $X \times \hat{X}$. This will introduce unnecessary conservatism and computational complexity in the cases when some of the X_{ij} are completely outside the resulting estimate of the region of attraction, since the Lyapunov decrease-condition will be ensured for subsets of no relevance for the final result. The result may be a non-successful termination of the algorithm in the sense that no feasible solution is found. In this case we may omit subsets X_{ij} that are completely outside the Lyapunov level set. This situation is sketched in Figure 3.3 (for simplicity, the local output sets are ignored). A practical consequence of leaving out some subsets X_{ij} is a reduction of the number of LMIs.

The argument above can be made irrespectively of which space $((x_k, \hat{x}_k)$ or (x_k, \tilde{x}_k)) the Lyapunov function maps from. Informally, it says that we

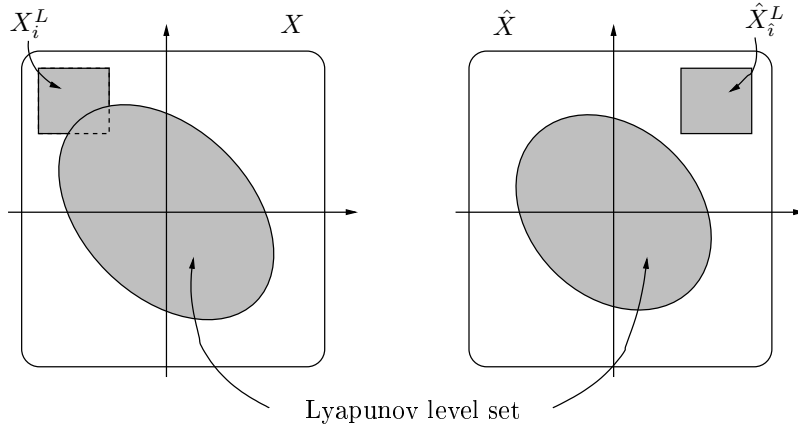

Figure 3.3: Illustration of one combination of X_i^L and \hat{X}_i^L which can be excluded.

may omit LMIs that imply checking Lyapunov function decrease when the observer state is far from the real state.

Since the estimate of the region of attraction is not known in advance, one must make an assumption about the size of it and check the assumption afterwards. However, R_A will give an indication of what it will look like. One can continue the process by reducing the size of those X_{ij} that are not expected to be entirely contained in the Lyapunov level set.

3.4 Separate synthesis of observer and state feedback

The combined synthesis in the previous section implies that a Lyapunov function for a system with $2n$ states must be found. Since the computational complexity grows exponentially with the number of states, it is important to investigate whether it is possible to separate the designs, meaning that instead of solving a problem with $2n$ states, we solve two synthesis problems with n states each.

3.4.1 Local results

The first attempt at a separate synthesis consists of two steps:

1. Synthesize a piecewise affine state-feedback, using the techniques in Slupphaug et al. (2000). This results in matrices K_s^i, k_s^i for each local model validity set i in the state-space. Call the piecewise affine state-feedback $\mu(x_k)$, and the resulting Lyapunov function $V_s(x_k; \theta_k) = x_k^\top P_s(\theta_k) x_k$. The state feedback region of attraction is larger than the ellipsoid R_A^s .
2. Use this state-feedback as observer state-feedback, with the observer state-space divided the same way as the system state-space. Then, inserting this into the closed-loop (3.9), use Theorem 3.1 to design an asymptotic observer, using $\Omega = [I \ -I]$. This results in matrices K_o^j, k_o^j for each local output set j (or, alternatively, matrices K_o^i, k_o^i for each local observer model validity set \hat{i} .) The resulting Lyapunov function³ is called $V_o(\tilde{x}_k; \theta_k) = \tilde{x}_k^\top P_o(\theta_k) \tilde{x}_k$. The “region of attraction” is larger than the ellipsoid R_A^o .

If input constraints are added to the state feedback synthesis, then the output feedback controller will respect the input constraints as long as $\hat{x}_k \in X$.

Using the above observer synthesis procedure, the LMIs for the intersection sets X_{ij} which has the origin in the interior, may not be strictly feasible due to the specific structure of these matrices. Most solvers for bilinear matrix inequalities are based on LMI-solvers that require strict feasibility for the matrix inequalities. Hence, the problem cannot be solved directly as stated using these solvers.

To overcome this problem, one can approximate these intersection sets by bounded polytopes or ellipsoids. Note that these approximating sets cannot contain the origin, so they cannot cover these intersection sets fully. This approach is not entirely satisfactory, since the stability guarantees then are lost.

The Lyapunov function $V_o(\tilde{x}_k; \theta_k)$ found for the observer error in step 2 above, will always be decreasing as long as the sequence (x_k, \hat{x}_k) stays within $X \times \hat{X}$. But the procedure does not guarantee that this will continue to be the case, even if the initial state is within the region of attraction for the state feedback. Hence only local asymptotic stability can be concluded, that is, convergence holds if the initial observer error and state are small enough.

These issues together make the direct separated approach outlined above unsatisfying. The aim of the next section is therefore to investigate if we

³Note that the parameter vector θ_k in general will have a higher dimension for the observer synthesis problem than for the state feedback synthesis problem. However, the parameter vector in the state feedback synthesis problem will be a subset of the parameter vector of the observer synthesis problem since the latter must consider both the observer and the system, hence no new notation to distinguish these will be introduced.

can find synthesis inequalities that give regional stability results, and do not have the implementational problems described above.

3.4.2 Regional results

The point of using piecewise affine models, is to obtain regional stability results. If only local asymptotic stability was of interest, one could resort to local (piecewise, parameter dependent) linear models, in which case the synthesis inequalities could be formulated as LMIs. Hence, it is of interest to see what can be done to obtain non-trivial guaranteed regions of attraction using the separated procedure.

An approach to obtain regional results using additional input uncertainty in the state feedback synthesis, is outlined in Imsland et al. (2001e). However, because of the conservative nature of this approach, in addition to a rather involved implementation, it is not pursued in further detail here.

A more appealing option to get regional results, is to use the Lyapunov function (i.e, $P_s(\theta)$ and S_s) from the state feedback synthesis to ensure that the output feedback control law is always making this Lyapunov function decrease. A naive implementation of this is adding LMIs to the observer synthesis to ensure that the state feedback Lyapunov function decreases for all intersections sets X_{ij} . However, these LMIs turn out to be infeasible by structure.

A better and less conservative approach is to use one Lyapunov function for the composite system, much like the approach in Section 3.3. By making the Lyapunov matrix block diagonal, we can choose the first block to be the state feedback Lyapunov matrix. That is, choose the Lyapunov function as

$$V(x_k, \tilde{x}_k, \theta) = x_k^\top P_s(\theta) x_k + \tilde{x}_k^\top P_o(\theta) \tilde{x}_k$$

(or, alternatively, substitute \tilde{x}_k with \hat{x}_k). Since $P_s(\theta)$ (and S_s and M_s) are given from the state feedback synthesis, it then remains to find $P_o(\theta)$ of dimension $n \times n$, compared to the $2n \times 2n$ Lyapunov matrix in Section 3.3. In the theorem below, $\Omega_s = [I \ 0]$ and $\Omega_o = [0 \ I]$ or $\Omega_o = [I \ -I]$ depending on if R_A is given in the (x_k, \hat{x}_k) -coordinates, or in the (x_k, \tilde{x}_k) -coordinates, respectively. Other definitions are as given in Section 3.3.5.

Theorem 3.2 *Let $P_s(\theta)$, S_s , M_s , $\{K_s^i\}_{i=1}^{N_L^o}$, $\{k_s^i\}_{i=N_{L_0}^o+1}^{N_L^o}$ be feasible variables from a state feedback synthesis (Slupphaug et al., 2000). Let Θ_0 be the corners of the parameter box Θ , i.e. $\Theta_0 = \{0, 1\}^{N_\theta}$. Then, if $\exists M_o > 0$, symmetric matrices $\{(P_o)_j\}_{j=0}^{N_\theta}$ and S_o , matrices of appropriate dimensions $\{K_o^j\}_{j=1}^{M_L}$, $\{k_o^j\}_{j=M_{L_0}+1}^{M_L}$, $\left\{ \left\{ W_j^l \right\}_{j=0}^{N_\theta} \right\}_{l=1}^{N^p}$, $\left\{ \left\{ \tau_j^l \right\}_{j=0}^{N_\theta} \right\}_{l=N^p+1}^N$ such that $\forall l \in I_{N^o}, \theta \in$*

Θ_0

$$\begin{bmatrix} S_s & 0 & \Omega_s A(K_s^{i_l}, K_o^{j_l}; \theta) \\ \star & S_o & \Omega_o A(K_s^{i_l}, K_o^{j_l}; \theta) \\ \star & \star & \Omega_s^\top (P_s(\theta) - M_s) \Omega_s + \Omega_o^\top (P_o(\theta) - M_o) \Omega_o - E_l^\top W^l(\theta) E_l \end{bmatrix} \geq 0 \quad (3.19)$$

 $\forall l \in \{N^o + 1, \dots, N^p\}, \theta \in \Theta_0$

$$\begin{bmatrix} S_s & 0 & \Omega_s A(K_s^{i_l}, K_o^{j_l}; \theta) & \Omega_{sc}(k_s^{i_l}, K_o^{j_l}, k_o^{j_l}; \theta) \\ \star & S_o & \Omega_o A(K_s^{i_l}, K_o^{j_l}; \theta) & \Omega_{oc}(k_s^{i_l}, K_o^{j_l}, k_o^{j_l}; \theta) \\ \star & \star & \Omega_s^\top (P_s(\theta) - M_s) \Omega_s + \Omega_o^\top (P_o(\theta) - M_o) \Omega_o - E_l^\top W^l(\theta) E_l & -E_l^\top W^l(\theta) e_l \\ \star & \star & \star & -e_l^\top W^l(\theta) e_l \end{bmatrix} \geq 0 \quad (3.20)$$

 $\forall l \in \{N^p + 1, \dots, N\}, \theta \in \Theta_0$

$$\begin{bmatrix} S_s & 0 & \Omega_s A(K_s^{i_l}, K_o^{j_l}; \theta) & \Omega_{sc}(k_s^{i_l}, K_o^{j_l}, k_o^{j_l}; \theta) \\ \star & S_o & \Omega_o A(K_s^{i_l}, K_o^{j_l}; \theta) & \Omega_{oc}(k_s^{i_l}, K_o^{j_l}, k_o^{j_l}; \theta) \\ \star & \star & \Omega_s^\top (P_s(\theta) - M_s) \Omega_s + \Omega_o^\top (P_o(\theta) - M_o) \Omega_o + \tau^l(\theta) E_l & \tau^l(\theta) e_l \\ \star & \star & \star & \tau^l(\theta) \epsilon_l \end{bmatrix} \geq 0 \quad (3.21)$$

 $\forall \theta \in \Theta_0$

$$0 < P_o(\theta) \leq S_o^{-1} \quad (3.22)$$

 and $\forall l \in I_{N^p}, \theta \in \Theta_0$

$$W^l(\theta) \in \mathbb{R}_+^{n_{E_l} \times n_{E_l}},$$

then the origin is an affinely quadratically stable equilibrium for the closed-loop system (implied by (3.19) and (3.22)), and the Lyapunov function is decreasing everywhere in $X \times \hat{X}$. If, in addition, there exist reals $\{\alpha_j\}_{j=0}^{N_\theta}$ and $\{\beta_j\}_{j=0}^{N_\theta}$ such that $\forall \theta \in \Theta_0$

$$\begin{bmatrix} \Omega_s^\top P_s(\theta) \Omega_s + \Omega_o^\top P_o(\theta) \Omega_o - \beta(\theta) R_A & 0 \\ 0 & \beta(\theta) - \alpha(\theta) \end{bmatrix} \leq 0 \quad (3.23)$$

and reals $\left\{ \left\{ \mu_j^l \right\}_{j=0}^{N_\theta} \right\}_{l \in I_{N_{q\xi}}}$ such that $\forall l \in I_{N_{q\xi}}, \theta \in \Theta_0$

$$\begin{bmatrix} \mu^l(\theta) H_{l,\xi} - \Omega_s^\top P_s(\theta) \Omega_s - \Omega_o^\top P_o(\theta) \Omega_o & -\mu^l(\theta) H_{l,\xi} \xi_{l,c} \\ \star & \mu^l(\theta) (\xi_{l,c}^\top H_{l,\xi} \xi_{l,c} - 1) + \alpha(\theta) \end{bmatrix} \leq 0, \quad (3.24)$$

then the origin is an affinely quadratically stable equilibrium with a region of attraction containing $\{z \mid \|z\|_{R_A}^2 \leq 1\}$ of at least $\{z \mid \exists \theta \in \Theta, z^\top P(\theta) z \leq \alpha(\theta)\}$.

A full proof would use the same steps as the proof of Theorem 2.1, and is hence omitted. The Schur complement step makes use of the equivalence (under the correct assumptions on the matrices involved)

$$L_1 - M_1^\top N_1^{-1} M_1 + L_2 - M_2^\top N_2^{-1} M_2 \geq 0$$

$$\Downarrow$$

$$\begin{bmatrix} N_1 & 0 & M_1 \\ 0 & N_2 & M_2 \\ M_1^\top & M_2^\top & L_1 + L_2 \end{bmatrix} \geq 0,$$

which is used for notational convenience.

Remark 3.1 *The variables $P_s(\theta)$ and M_s can be taken as (free) LMI variables in Theorem 3.2, provided the LMIs*

$$0 \leq P_s(\theta) \leq S_s^{-1}$$

(in addition to $M_s > 0$) are added. Also, $\{K_s^i\}_{i=1}^{N_L^o}$ and $\{k_s^i\}_{i=N_{L_0}^o+1}^{N_L^o}$ can be taken as free LMI variables. This will make the optimization problem larger, but could be less conservative.

As for the procedure in Section 3.4.1, if input constraints are included in the state feedback synthesis, then the output feedback controller will respect the input constraints as long as $\hat{x}_k \in X$. One could, alternatively, add the input constraint LMIs to the second step similarly to Section 3.3.6, but this will not be pursued in further detail. The same steps as in Section 3.3.7 can be taken to reduce conservatism.

The advantage of this formulation compared to Theorem 3.1 is the reduction of parameters in the Lyapunov function (which are the “complicating variables”, i.e. the variables in the non-convex matrix inequalities (3.15)). In Theorem 3.1, the number of complicating variables is growing quadratically in $2n$, while in Theorem 3.2, it is growing quadratically in n . This reduction is of advantage for both local but especially global BMI solvers, which typically use “branch and bound” in a space of the same dimension as the number of complicating variables. However, in both approaches, the number of LMIs grow exponentially in N_θ .

Systems with direct feed-through

Since the state feedback parameters and the observer injection parameters are calculated in two different steps, these parameters can be allowed to

enter bilinearly in the closed-loop system equations. This fact can be exploited to expand the system class to systems with “direct feed-through”, that is, systems where the measurement mapping (3.2) depends on u_k , $y_k \in \mathcal{G}(x_k, u_k, \Psi) \subset \mathcal{H}_{i(x_k)}(x_k, u_k, \Theta^s) = \{y | \exists \theta \in \Theta^s, y = C^i(\theta)x_k + D^i(\theta)u_k + d^i(\theta)\}$, and corresponding observer. The closed loop equations can still be written as in (3.9) with

$$\begin{aligned} \mathbf{A} \left(K_s^i, K_o^j; \theta_k \right) &= \begin{bmatrix} A^i(\theta_k^s) & 0 \\ 0 & \hat{A}^i(\theta_k^o) \end{bmatrix} + \begin{bmatrix} B^i(\theta_k^s) \\ \hat{B}^i(\theta_k^o) \end{bmatrix} K_s^i \begin{bmatrix} 0 & I \end{bmatrix} \\ &+ \begin{bmatrix} 0 \\ I \end{bmatrix} K_o^j \begin{bmatrix} C^i(\theta_k^s) & -\hat{C}^i(\theta_k^o) \end{bmatrix} + \begin{bmatrix} 0 \\ I \end{bmatrix} K_o^j \left(D^i(\theta_k^s) - \hat{D}^i(\theta_k^o) \right) K_s^i \begin{bmatrix} 0 & I \end{bmatrix} \\ \mathbf{c} \left(k_s^i, K_o^j, k_o^j; \theta_k \right) &= \begin{bmatrix} c^i(\theta_k^s) \\ \hat{c}^i(\theta_k^o) \end{bmatrix} + \begin{bmatrix} B^i(\theta_k^s) \\ \hat{B}^i(\theta_k^o) \end{bmatrix} k_s^i \\ &+ \begin{bmatrix} 0 \\ I \end{bmatrix} K_o^j \left(D^i(\theta_k^s) - \hat{D}^i(\theta_k^o) \right) k_s^i + \begin{bmatrix} 0 \\ I \end{bmatrix} K_o^j \left(d^i(\theta_k^s) - \hat{d}^i(\theta_k^o) \right) + \begin{bmatrix} 0 \\ I \end{bmatrix} k_o^j, \end{aligned}$$

which can be used in Theorem 3.2.

3.5 Examples

3.5.1 An unstable nonlinear system

Consider the uncertain constrained nonlinear system

$$\begin{aligned} \dot{x}_1(t) &= a(t)x_1(t) + x_2(t) \\ \dot{x}_2(t) &= \sin(x_1(t)) - .5x_2(t) + u(t) \\ y(t) &= x_1(t) \\ a(t) &\in [-.1, -.3] \\ |x_1(t)| &\leq 2, \quad |x_2(t)| \leq 20 \\ |u(t)| &\leq 100 \end{aligned}$$

which has an unstable equilibrium at the origin. The objective is to find a piecewise affine controller/observer structure using the techniques developed herein that robustly stabilizes the origin for all allowed values of $a(t)$ and give the closed loop system a region of attraction R_A of at least $[x^\top \tilde{x}^\top]^\top \in \{z | z^\top \text{diag}(1.4, 12, .8, 5)z \leq 1\}$. To this end, the system is discretized using the forward Euler method and a sample interval $h = 0.01$. The nonlinearity is upper and lower bounded by piecewise affine functions for use in the system

description, while a piecewise affine approximation is used in the observer. See Figure 3.4.

The derivation of such bounds and an uncertainty model based on them, is described in Slupphaug et al. (2000). Together with the uncertain parameter $a(t)$ this gives models with $N_\theta = 2$, in four local model validity sets, given by

$$\begin{aligned} X_1^L &= \{x | 0 \leq x_1 \leq 1\} \\ X_2^L &= \{x | -1 \leq x_1 \leq 0\} \\ X_3^L &= \{x | 1 \leq x_1 \leq 2\} \\ X_4^L &= \{x | -2 \leq x_1 \leq -1\}. \end{aligned}$$

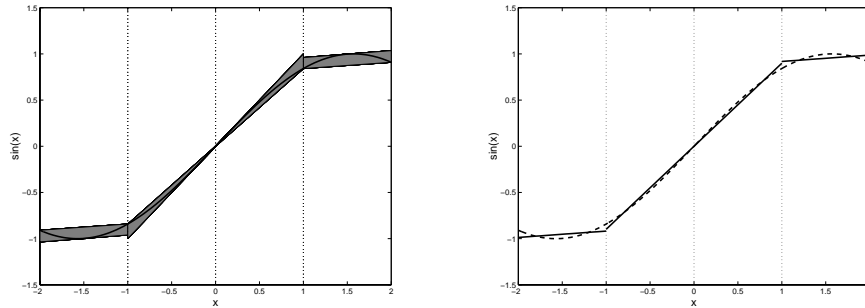

Figure 3.4: Piecewise affine bounding and approximation.

Combined synthesis

Using the algorithm in Section 2.4, the controller and observer parameters shown in Table 3.1 are found. Simulated phase trajectories of the closed loop are shown in Figure 3.5. Note that though it may seem like the state trajectory is not entering smaller Lyapunov function level sets at all times, the total Lyapunov function is in fact decreasing. The apparent contradiction stems from the fact that only a projection of the four-dimensional total state trajectory (x_k, \tilde{x}_k) and the Lyapunov level set is shown.

In Figure 3.8 we see that the input is within its constraints.

Separated synthesis

The separated synthesis of Section 3.4.2 is used for the same system (with the same R_A specified) as in the previous section.

	u_k	v_k		
$0 \leq \hat{x}_{1,k} < 1$	$[-36.6967, -2.6470]\hat{x}_k$	0.0674 0.1545	$(y_k - \hat{y}_k)$	
$-1 \leq \hat{x}_{1,k} < 0$	$[-36.3622, -2.6245]\hat{x}_k$	0.0711 0.1575	$(y_k - \hat{y}_k)$	
$1 \leq \hat{x}_{1,k} \leq 2$	$[-39.3421, -0.9139]\hat{x}_k - 2.9621$	0.1097 0.2439	$(y_k - \hat{y}_k) -$	0.0096 0.0249
$-2 \leq \hat{x}_{1,k} < -1$	$[-39.4195, -0.9026]\hat{x}_k + 3.0488$	0.1105 0.2518	$(y_k - \hat{y}_k) +$	0.0099 0.0255

Table 3.1: Controller and observer matrices - combined synthesis

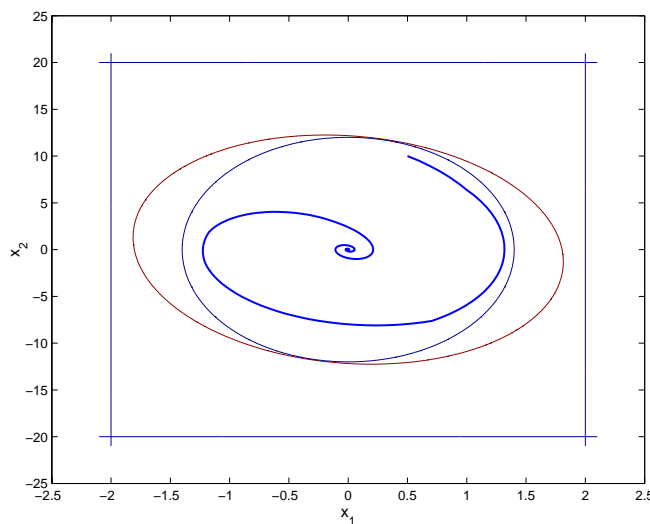

Figure 3.5: The state phase trajectory. The inner ellipsoid is the projection of R_A , the outer ellipsoid is the projection of an estimate of the region of attraction based on the computed Lyapunov function.

The first iteration in the combined synthesis case uses 85 seconds⁴. For the separate synthesis case, the first iteration of the observer synthesis uses 17 seconds, while the feedback synthesis uses 5 seconds.

In addition, for this example, the separated observer synthesis terminates after the first iteration; while the combined synthesis uses 22 iterations (a

⁴The later iterations are about 10 times faster, since information from the previous iterations can be used. All computations were carried out on a PC with an AMD Athlon Thunderbird 1.4GHz processor with 768MB RAM, using Matlab under Linux.

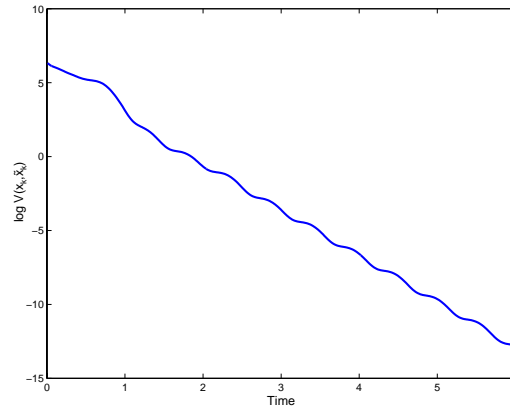

Figure 3.6: The value of the Lyapunov function versus time.

smaller R_A will reduce the number of iterations for the combined synthesis).

One would expect that the achievable region of attraction would be larger for the combined synthesis, since the separated procedure has less degrees of freedom in the observer synthesis. This example indicates the opposite, but no conclusions can be drawn from this, since the synthesis problems are non-convex optimization problems.

The controller matrices for the separated synthesis are given in Table 3.2. A simulation is shown in Figures 3.9 and 3.10.

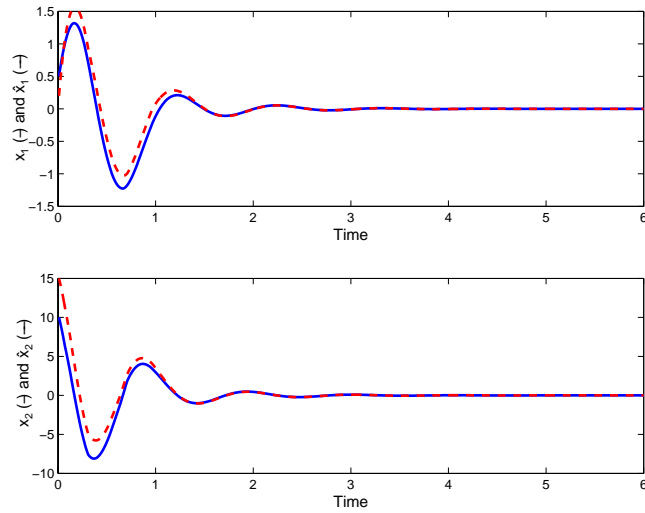

Figure 3.7: The state and the observer state simulated with the observer/controller synthesized using the combined synthesis, with initial conditions $x = (.5, 10)$ and $\tilde{x} = (.2, 15)$.

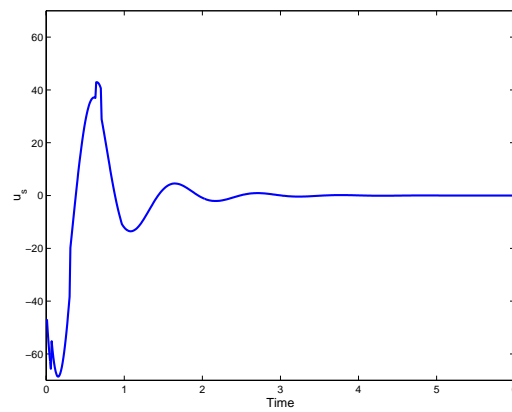

Figure 3.8: The input, u_k , combined synthesis. Note that $|u_k| \leq 100$.

	u_k	v_k		
$0 \leq \hat{x}_{1,k} < 1$	$[-40.4731, -2.1144]\hat{x}_k$		$\begin{matrix} 0.9987 \\ 0.0180 \end{matrix}$	$(y_k - \hat{y}_k)$
$-1 \leq \hat{x}_{1,k} < 0$	$[-40.6318, -2.1110]\hat{x}_k$		$\begin{matrix} 0.9985 \\ 0.0216 \end{matrix}$	$(y_k - \hat{y}_k)$
$1 \leq \hat{x}_{1,k} \leq 2$	$[-39.2835, -0.8226]\hat{x}_k - 1.4940$	$\begin{matrix} 1.0113 \\ 0.1180 \end{matrix}$	$(y_k - \hat{y}_k) +$	$\begin{matrix} 0.0001 \\ -0.0074 \end{matrix}$
$-2 \leq \hat{x}_{1,k} < -1$	$[-39.2824, -0.8181]\hat{x}_k + 1.6127$	$\begin{matrix} 1.0131 \\ 0.1589 \end{matrix}$	$(y_k - \hat{y}_k) +$	$\begin{matrix} -0.0001 \\ 0.0071 \end{matrix}$

Table 3.2: Controller and observer matrices - separated synthesis

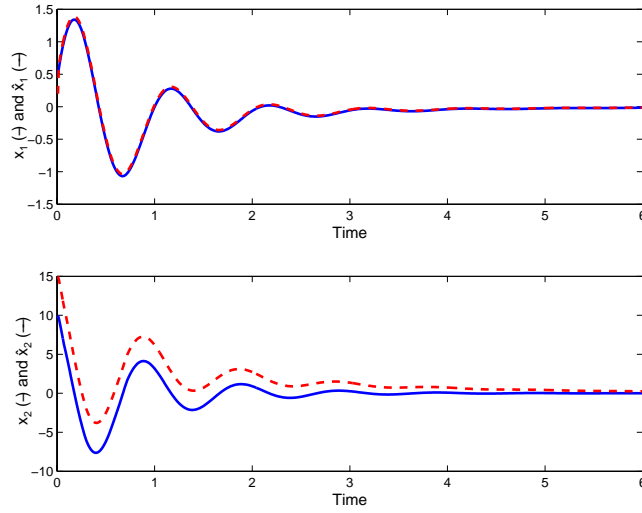

Figure 3.9: The state and the observer state simulated with the observer/controller synthesized using the separated synthesis, with initial conditions $x = (.5, 10)$ and $\tilde{x} = (.2, 15)$.

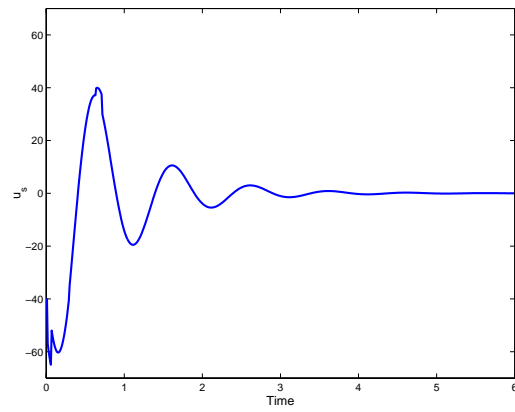

Figure 3.10: The input, u_k , separated synthesis. Note that $|u_k| \leq 100$.

3.5.2 Wheel slip control

In the second example, we will consider wheel slip control for use in anti-lock brake systems (ABS brakes) on cars. This example will illustrate that the proposed feedback scheme in some cases can have the effect of an integral controller, and additionally, it can be used in a gain-scheduled way. The purpose of this section⁵ is to illustrate how the controller can be applied, not to present a fully realistic output feedback ABS controller.

The dynamics of a single wheel (quarter car), see Figure 3.11, is assumed described by

$$m\dot{v} = -F_x \quad (3.25)$$

$$J\dot{\omega} = rF_x - T_b \text{sign}(\omega), \quad (3.26)$$

taken from Petersen, Johansen, Kalkkuhl and Lüdemann (2001). The symbols are explained in Table 3.3.

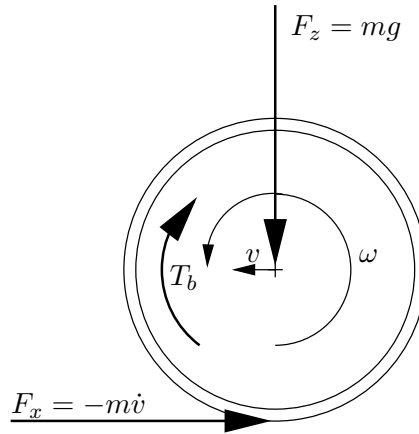

Figure 3.11: Velocities, forces and torque on quarter car

A common assumption in tire friction models is that the tire friction coefficient μ ,

$$\mu := \frac{F_x}{F_z} = \frac{\text{Friction force}}{\text{Vertical force}}, \quad (3.27)$$

is a nonlinear function (see Figure 3.12) of the tire slip λ (only⁶),

$$\lambda := \frac{v - \omega r}{v}. \quad (3.28)$$

⁵Idar Petersen is acknowledged for his helpful comments on this Section.

⁶In addition, μ will depend on the friction coefficient μ_H between tire and road, and the side-slip angle α of the wheel, both assumed constant herein ($\mu_H = .8$ and $\alpha = 0$).

symbol	explanation	value
v	car's horizontal speed	
ω	wheel angular speed	
F_z	vertical force on wheel	mg
F_x	tire friction force	
T_b	brake torque	
r	wheel radius	.32 m
J	wheel inertia	1 kg m ²
m	mass of quarter car	450 kg
g	acceleration of gravity	9.81 m/s ²

Table 3.3: Parameters in quarter car model

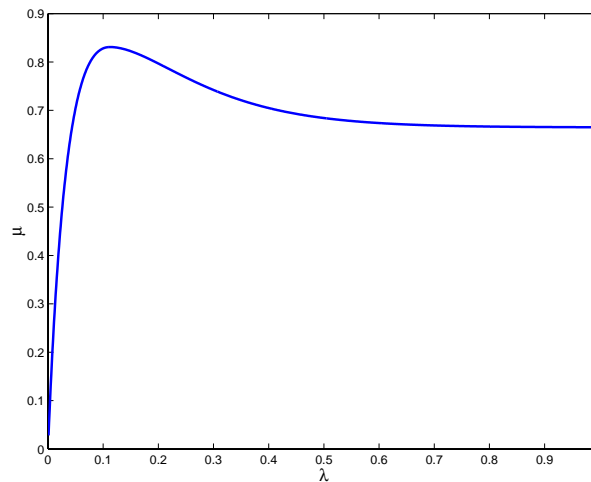

Figure 3.12: The friction $\mu(\lambda)$ corresponding to a friction coefficient of $\mu_H = .8$ (dry asphalt) and side-slip angle $\alpha = 0$.

Hence, $F_x = F_z\mu(\lambda)$, with $F_z = mg$ (assumed constant). Introducing the slip as a state, we find for $v > 0$, $\omega \geq 0$ that

$$\dot{\lambda} = -\frac{1}{v} \left(\frac{1}{m} (1 - \lambda) + \frac{r^2}{J} \right) F_z\mu(\lambda) + \frac{r}{vJ} T_b. \quad (3.29)$$

The dynamics of the speed of the car,

$$\dot{v} = -\frac{1}{m} F_z\mu(\lambda) \quad (3.30)$$

will be much slower than the slip dynamics, and hence we will look at v as a "disturbance" to the slip dynamics. We will design a slip controller

for the car speed in a (small) interval. The manipulated variable is T_b , ignoring actuator dynamics. The total controller will consist of a range of these controllers, covering the possible values of v , i.e. gain scheduled on v . Our control objective is to return to zero velocity as quickly as possible, and this is achieved by keeping the slip as close to the maximum point on the friction curve (Figure 3.12) as possible. The optimal slip value λ^* is assumed constant (independent of v), which is a good approximation in a limited velocity range. The brake torque is upper and lower constrained, $T_b^{min} \leq T_b \leq T_b^{max}$.

Combined synthesis

To get zero slip as equilibrium, we introduce the deviation variables $\chi_1 = \lambda - \lambda^*$ and $u = T_b - T_b^*$ with

$$T_b^* := \left(\frac{J}{mr} (1 - \lambda^*) + r \right) F_z \mu(\lambda^*) \quad (3.31)$$

(note that the equilibrium control is independent of the velocity) and get that the deviation slip dynamics is described by

$$\dot{\chi}_1 = -\frac{1}{v} \left(\frac{1}{m} (1 - \lambda^*) + \frac{r^2}{J} \right) F_z [\mu(\chi_1 + \lambda^*) - \mu(\lambda^*)] + \frac{F_z}{mv} \chi_1 \mu(\chi_1 + \lambda^*) + \frac{r}{Jv} u. \quad (3.32)$$

with an unstable equilibrium at $\chi_1 = 0$.

The measured variable is the angular velocity of the wheel, ω :

$$\omega = \frac{v}{r} (1 - \lambda). \quad (3.33)$$

If we knew v exactly, λ would be completely determined from ω , and we could control the slip using state feedback (with the slip as the state). This is the approach taken in e.g. Petersen et al. (2001), where integral control is used to compensate for not knowing the equilibrium input due to unknown slip coefficient. The velocity (and slip) is assumed estimated online using an extended Kalman filter based on wheel speed (ω) and acceleration measurements.

In this example, we will assume that we know the (assumed constant) slip coefficient μ_H and hence the equilibrium input T_b^* , but that the velocity v is not known. We will therefore use an observer to estimate the slip (and the velocity). Assuming that we obtain a good slip controller, the (slow) dynamics of the velocity will be closely approximated by (taking $\chi_2 = v$)

$$\dot{\chi}_2 = -\frac{1}{m\bar{v}} F_z \mu(\lambda^*) \chi_2 \approx -\eta \chi_2 \quad (3.34)$$

i	$A_{11}^i(\theta_1)$	$c_1^i(\theta_1)$	X_i^L
1	$1.0080 + .0060\theta_1$		$\{\chi_1 0 \leq \chi_1 \leq .2\}$
2	$1.0078 - .0031\theta_1$		$\{\chi_1 -.03 \leq \chi_1 \leq 0\}$
3	$1.0024 - .0010\theta_1$	$.0019 + .0015\theta_1$	$\{\chi_1 .2 \leq \chi_1 \leq .86\}$
4	$.9838 - .0039\theta_1$	$-.0007 + .00002\theta_1$	$\{\chi_1 -.06 \leq \chi_1 \leq -.03\}$
5	$.8228 - .0753\theta_1$	$-.0134 + .0013\theta_1$	$\{\chi_1 -.14 \leq \chi_1 \leq -.06\}$

Table 3.4: The piecewise affine bounding functions

for velocities close to \bar{v} . The measurement equation can now be written as

$$\omega = -\frac{v}{r}\chi_1 + \frac{1}{r}(1 - \lambda^*)\chi_2 \quad (3.35)$$

where v in the first part is regarded as model uncertainty.

The system equations are discretized with forward Euler, using a step size $h = 0.001$. Note that the stiffness of the system does not introduce problems, since we are interested in the fast dynamics. For the purpose of this example, we will look at the speed interval $v \in [18, 20] \frac{m}{s}$, using $\lambda^* = .14$. As mentioned earlier, the total controller will consist of controllers for a number of velocity ranges covering the possible values for the velocity. These ranges should overlap to account for the uncertainty in the estimate of v .

The discretized model with state $\chi = [\chi_1 \ \chi_2]^T$ can be written on the form

$$\begin{aligned} \chi_{k+1} &= A^i(\theta)\chi_k + B^i(\theta)u_k + c^i(\theta) \\ &= \begin{bmatrix} A_{11}^i(\theta_1) & 0 \\ 0 & 1 - h\eta \end{bmatrix} \chi_k + \begin{bmatrix} B_1^i(\theta_2) \\ 0 \end{bmatrix} u_k + \begin{bmatrix} c_1^i(\theta_1) \\ 0 \end{bmatrix} \\ y_k &= C^i(\theta)\chi_k + d^i(\theta) = \begin{bmatrix} C_1^i(\theta_2) & \frac{1}{r}(1 - \lambda^*) \end{bmatrix} \chi_k \end{aligned}$$

which is on the desired form. The functions $B_1^i(\theta_2) = 1.6e^{-5} + .18e^{-5}\theta_2$ and⁷ $C_1^i(\theta_2) = -62.5 + 6.25\theta_2$ are found in a straightforward manner, and are the same in all local model validity sets, i.e. independent of i . More involved, $A_{11}^i(\theta_1)$ and $c_1^i(\theta_1)$ (see Table 3.4) are found using the methods of Slupphaug et al. (2000) by upper and lower the part of (3.32) that depends on χ_1 , see Figure 3.13.

⁷In the interval we look at here, $1/v$ can be regarded as affine in v with good accuracy, and hence we can take $\theta_2 = \theta_3$ to save some computational complexity.

i	$A^i \chi_1 + c^i$	X_i^L
1	$1.013\chi_1$	$\{\chi_1 0 \leq \chi_1 \leq .2\}$
2	$1.005\chi_1$	$\{\chi_1 -.03 \leq \chi_1 \leq 0\}$
3	$1.002\chi_1 + .0026$	$\{\chi_1 .2 \leq \chi_1 \leq .86\}$
4	$.9815\chi_1 - .0007$	$\{\chi_1 -.06 \leq \chi_1 \leq -.03\}$
5	$.7795\chi_1 - .0156$	$\{\chi_1 -.14 \leq \chi_1 \leq -.06\}$

Table 3.5: The piecewise affine approximating functions

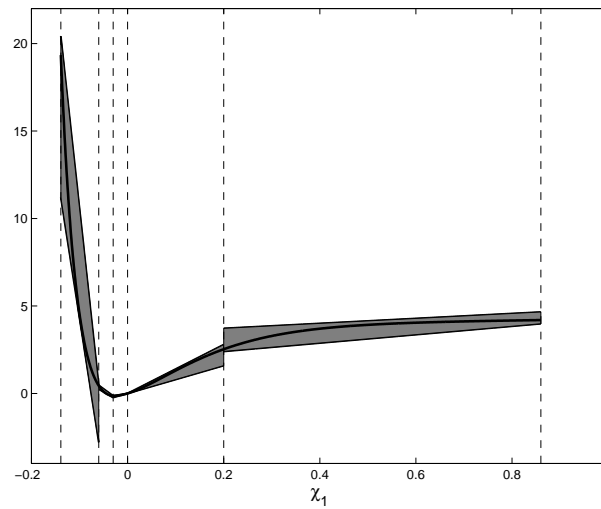

Figure 3.13: The piecewise affine bounding functions

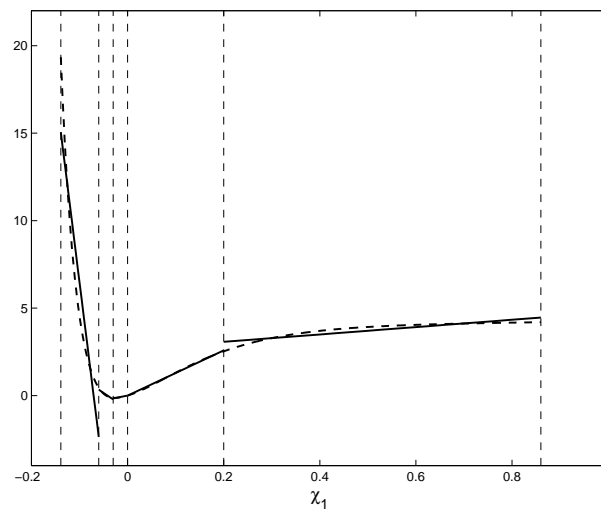

Figure 3.14: The piecewise affine approximating functions

The observer is of the form

$$\begin{aligned}\hat{\chi}_{k+1} &= \hat{A}^{\hat{i}}\chi_k + \hat{B}^{\hat{i}}u_k + \hat{c}^{\hat{i}} = \begin{bmatrix} \hat{A}_{11}^{\hat{i}} & 0 \\ 0 & 1 - h\eta \end{bmatrix} \chi_k + \begin{bmatrix} \hat{B}_1^{\hat{i}} \\ 0 \end{bmatrix} u_k + \begin{bmatrix} \hat{c}_1^{\hat{i}} \\ 0 \end{bmatrix} \\ y_k &= \hat{C}^{\hat{i}}\chi_k + \hat{d}^{\hat{i}} = \begin{bmatrix} \hat{C}_{11}^{\hat{i}} & \frac{1}{r}(1 - \lambda^*) \end{bmatrix} \chi_k\end{aligned}$$

with $\hat{B}_1^{\hat{i}} = 1.7e^{-4}$ and $\hat{C}_{11}^{\hat{i}} = 59.375$ for all \hat{i} . The values for $\hat{A}_{11}^{\hat{i}}$ and $\hat{c}_1^{\hat{i}}$ are found in Table 3.5, see also Figure 3.14.

Due to the non-symmetry of the state-space and that the resulting region of attraction will be given as a symmetric ellipsoid, we will "artificially" expand the dynamics for negative slip values to get a region of attraction including large slip values. This will not have any practical influence on the closed loop, since we are braking and not accelerating, the slip cannot become negative (Petersen et al., 2001, Proposition 1).

The controller and observer found by the combined approach are given in Table 3.6. Note that we used "process knowledge" in the optimizations, by forcing $K_s^{\hat{i}}(1, 2) = 0$.

\hat{x}_2^t	u_k	v_k		
$0 \leq \hat{\chi}_{1,k} < .2$	$[-4276, 0]\hat{\chi}_k$		$\begin{matrix} -0.0133 \\ 0.0011 \end{matrix}$	$(y_k - \hat{y}_k)$
$-.03 \leq \hat{\chi}_{1,k} < 0$	$[-10385, 0]\hat{\chi}_k$		$\begin{matrix} -0.0131 \\ 0.0011 \end{matrix}$	$(y_k - \hat{y}_k)$
$.2 \leq \hat{\chi}_{1,k} \leq .86$	$[51.28, 0]\hat{\chi}_k - 1054$	$\begin{matrix} -.0193 \\ .0018 \end{matrix}$	$(y_k - \hat{y}_k) +$	$\begin{matrix} -0.0207 \\ 0.0018 \end{matrix}$
$-.06 \leq \hat{\chi}_{1,k} < -.03$	$[-7561, 0]\hat{\chi}_k + 854.5$	$\begin{matrix} -0.0216 \\ 0.0026 \end{matrix}$	$(y_k - \hat{y}_k) +$	$\begin{matrix} -0.0258 \\ 0.0023 \end{matrix}$
$-.14 \leq \hat{\chi}_{1,k} < -.06$	$[-13686, 0]\hat{\chi}_k + 1466$	$\begin{matrix} -0.0179 \\ 0.0022 \end{matrix}$	$(y_k - \hat{y}_k) +$	$\begin{matrix} 0.0287 \\ 0.0028 \end{matrix}$

Table 3.6: Controller and observer matrices, combined synthesis

The simulations in Figure 3.15 show that even though the system using this controller is stable (since the synthesis equations are feasible, see also the Lyapunov function in Figure 3.16), the performance is not acceptable, at least for some initial conditions. In the time-scale of the slip dynamics it looks like a steady state error, even though the observer error $(y_k - \hat{y}_k)$ is approximately zero already after 5 ms. This behavior can be seen as a result of poor observability due to the multiplicity in the output mapping. Feeding further information into the observer (like acceleration measurements), will probably make the observer convergence better.

3. ROBUST OUTPUT FEEDBACK USING P-A OBSERVERS AND CONTROLLERS

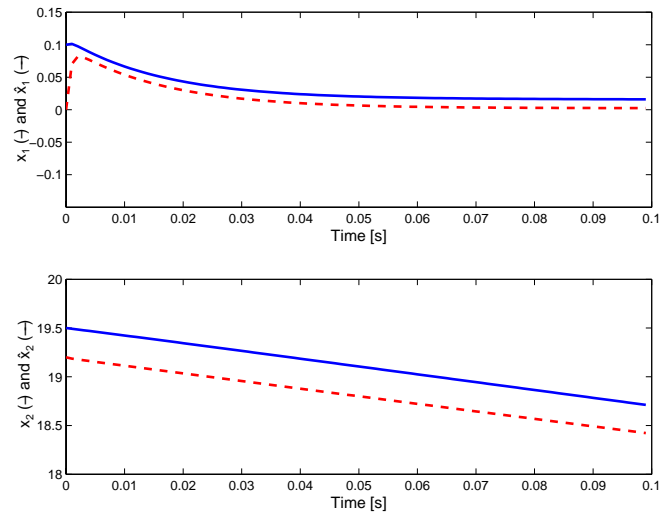

Figure 3.15: The state and observer state, combined synthesis

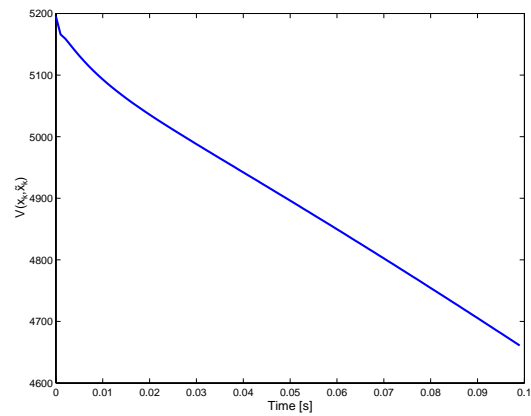

Figure 3.16: The Lyapunov function, combined synthesis

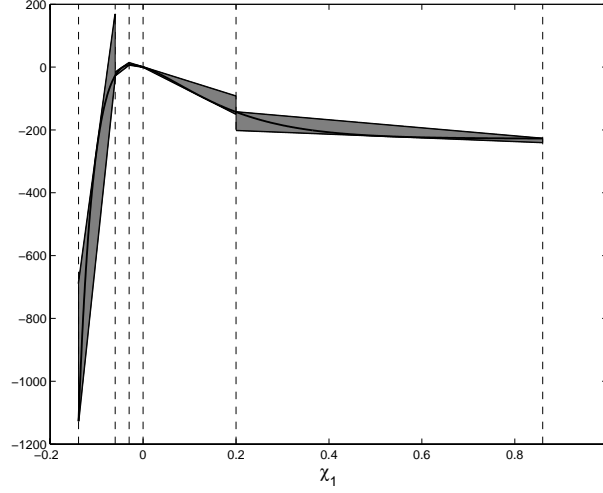

Figure 3.17: The piecewise affine bounding functions

Separated synthesis

In the separated synthesis, we will exploit that it is possible to add measurements with “direct feed-through”, to improve the performance of the controller/observer-structure of the combined synthesis in the previous section.

The system has two states, as in the previous section, but we now include $\dot{\omega}$ as a measurement, $\dot{\omega} = \frac{r}{J}F_z\mu(\lambda) + \frac{1}{J}T_b$. Corrected for zero offset at the equilibrium, it becomes $y_2 = \dot{\omega} - \frac{r}{J}F_z\mu(\lambda^*) - \frac{1}{J}T_b^* = \frac{r}{J}F_z\mu(\chi_1 + \lambda^*) - \frac{r}{J}F_z\mu(\lambda^*) + \frac{1}{J}u$. We see that the measurement is a function of the input, and hence output models of the class in Section 3.4.2 must be used:

$$\begin{aligned} y_k &= C^i(\theta)\chi_k + D^i(\theta)u_k + d^i(\theta) \\ &= \begin{bmatrix} C_{11}^i(\theta_2) & \frac{1}{r}(1 - \lambda^*) \\ C_{12}^i(\theta_3) & 0 \end{bmatrix} \chi_k + \begin{bmatrix} 0 \\ D_1^i \end{bmatrix} u_k + \begin{bmatrix} 0 \\ d_2^i(\theta_3) \end{bmatrix} \\ \hat{y}_k &= \hat{C}^i \hat{\chi}_k + \hat{D}^i u_k + \hat{d}^i = \begin{bmatrix} \hat{C}_{11}^i & \frac{1}{r}(1 - \lambda^*) \\ \hat{C}_{12}^i & 0 \end{bmatrix} \hat{\chi}_k + \begin{bmatrix} 0 \\ \hat{D}_1^i \end{bmatrix} u_k + \begin{bmatrix} 0 \\ \hat{d}_2^i \end{bmatrix} \end{aligned}$$

with $C_{11}^i(\theta_2)$ and \hat{C}_{11}^i as in section 3.5.2. Further, $D_1^i = \hat{D}_1^i = 1$ and \hat{C}_{21}^i , \hat{d}_2^i and $C_{12}^i(\theta_3)$, $d_2^i(\theta_3)$ is found using the same methods as before, see Figures 3.17 and 3.18 and Tables 3.7 and 3.8.

State feedback matrices and the observer matrices found from a feasible solution of the synthesis inequalities, can be seen in Table 3.9. In the simulation in Figure 3.19, we see that the convergence of the slip estimate is better

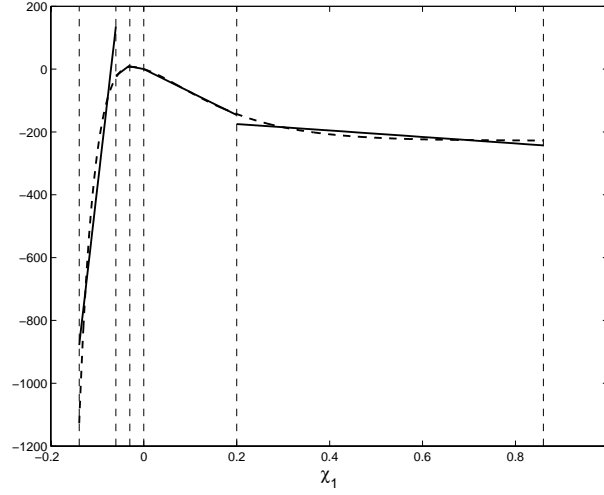

Figure 3.18: The piecewise affine approximating functions

i	$C_{21}^i(\theta_3)$	$d_2^i(\theta_3)$	X_i^L
1	$747.96 + 284.56\theta_3$		$\{\chi_1 0 \leq \chi_1 \leq .2\}$
2	$-230.51 - 220.91\theta_3$		$\{\chi_1 -.03 \leq \chi_1 \leq 0\}$
3	$-58.75 - 69.09\theta_3$	$-189.29 + 71.96\theta_3$	$\{\chi_1 .2 \leq \chi_1 \leq .86\}$
4	$1132.8 - 116.70\theta_3$	$40.87 + 3.55\theta_3$	$\{\chi_1 -.06 \leq \chi_1 \leq -.03\}$
5	$13928 - 3061.1\theta_3$	$808.67 + 12.46\theta_3$	$\{\chi_1 -.14 \leq \chi_1 \leq -.06\}$

Table 3.7: The piecewise affine bounding functions

i	$\hat{C}_{21}^i\chi_1 + \hat{d}_2^i$	X_i^L
1	$-730.34\chi_1$	$\{\chi_1 0 \leq \chi_1 \leq .2\}$
2	$-291.06\chi_1$	$\{\chi_1 -.03 \leq \chi_1 \leq 0\}$
3	$-103.00\chi_1 - 154.21$	$\{\chi_1 .2 \leq \chi_1 \leq .86\}$
4	$1104.8\chi_1 + 45.25$	$\{\chi_1 -.06 \leq \chi_1 \leq -.03\}$
5	$12840\chi_1 + 906.18$	$\{\chi_1 -.14 \leq \chi_1 \leq -.06\}$

Table 3.8: The piecewise affine approximating functions

compared to Figure 3.15, and that the output feedback controller structure has acceptable performance.

\hat{X}_i^L	u_k	v_k			
$0 \leq \hat{\chi}_{1,k} < .2$	$[-4288, 0]\hat{\chi}_k$		-0.0162 0.0086	-0.0001 -0.0008	$(y_k - \hat{y}_k)$
$-.03 \leq \hat{\chi}_{1,k} < 0$	$[-51858, 0]\hat{\chi}_k$		-0.0165 0.0050	-0.0001 -0.0007	$(y_k - \hat{y}_k)$
$.2 \leq \hat{\chi}_{1,k} \leq .86$	$[-7176, 0]\hat{\chi}_k + 8360$	-0.016 0.0010	-0.0002 -0.0003	$(y_k - \hat{y}_k) +$	0.00 -0.0210
$-.06 \leq \hat{\chi}_{1,k} < -.03$	$[-10159, 0]\hat{\chi}_k + 10226$	-0.0051 0.1809	0.0006 0.0098	$(y_k - \hat{y}_k) +$	0.0012 0.0091
$-.14 \leq \hat{\chi}_{1,k} < -.06$	$[-6421, 0]\hat{\chi}_k + 10374$	-0.0093 0.0689	0.0000 0.0003	$(y_k - \hat{y}_k) +$	0.0018 0.0018

Table 3.9: Controller and observer matrices, separated synthesis

3.6 Discussion and concluding remarks

A mathematical programming-based approach for synthesizing observers and observer-state feedback for discrete-time constrained uncertain non-linear

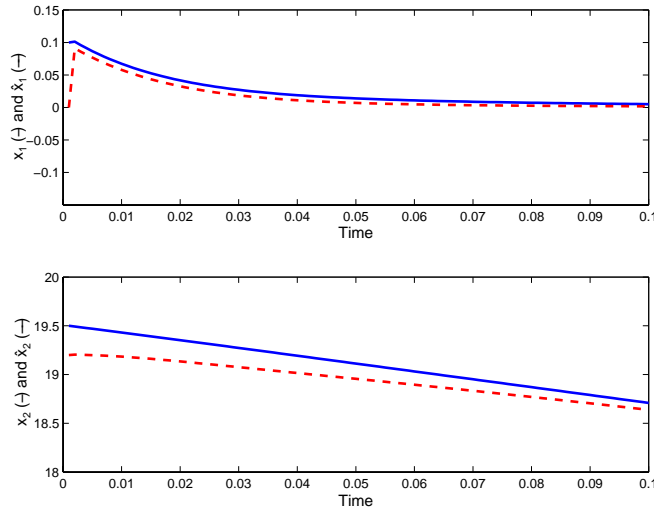

Figure 3.19: The state and observer state, separated synthesis

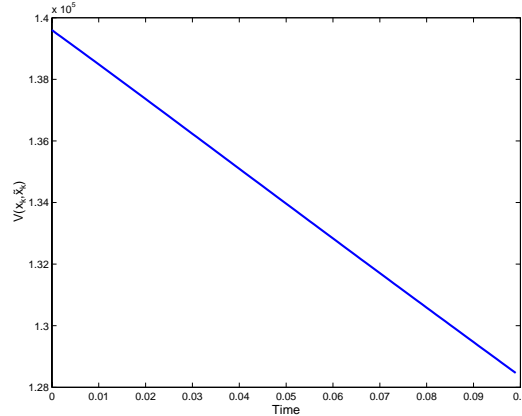

Figure 3.20: The Lyapunov function, separated synthesis

systems is presented. The observer-state feedback and observer output injection has a piecewise affine structure. An estimate of the region of attraction larger than a prescribed minimum region of attraction is given as a Lyapunov level set. The region of attraction can be given in the state and observer-error variables, or the state and observer-state variables. In addition to the *combined* synthesis of observer output injection and state feedback controller parameters, a synthesis procedure based on *separation* was developed. This procedure reduces computational complexity and is applicable to a larger class of systems than the combined synthesis, while giving the same stability guarantees. The separate synthesis is more conservative in theory since a block diagonal Lyapunov matrix is used, compared with the full Lyapunov matrix of the combined design. However, due to the non-convex structure of the synthesis inequalities, and the lower complexity of the separated synthesis, this conservatism might not be apparent in examples.

An advantage of using observers compared to the approach in Slupphaug et al. (2000), is that uncertainty (or nonlinearity) in the output mapping in Slupphaug et al. (2000) results in a closed loop system with parameters that enter quadratically. This is handled conservatively in the synthesis inequalities, while for the approach herein, uncertainties (or nonlinearities) in the output mapping does not present any problem regarding conservatism of the synthesis inequalities. Both here and in Slupphaug et al. (2000), uncertainties (or nonlinearities) in the output mapping can make it harder to find the sets (the X_{iijs} in the notation used herein) with the same closed loop dynamics.

In the first example, a parameter dependent Lyapunov matrix was used. However, doing the synthesis with a parameter independent Lyapunov matrix, achieved the same region of attraction. This might indicate that nothing much is gained using parameter dependent Lyapunov functions. However, such a conclusion would merely hold for this example. In addition comes the added complexity of using parameter dependent Lyapunov matrices which could affect the chosen solver's possibility to exploit the extra flexibility. In the second example, a parameter independent Lyapunov matrix was used.

In addition to what is discussed here, the issues discussed in Section 2.5 apply to the approach of this chapter as well.

A major issue is the growth in computational complexity that makes the presented approach prohibitive as the number of states and local model validity sets grow. If parts of the system are linear and known, however, this can be exploited and may significantly reduce the size of the feasibility problem.

Finally we note that the procedure developed herein can be used for analyzing and synthesizing observer-state feedback with robust stability guarantees for an a priori given observer, since it allows for a general nonlinear observer.

Part II

Output Feedback Nonlinear
Predictive Control

Chapter 4

Output feedback Nonlinear Model Predictive Control - Stability, Performance and Robustness in the Instantaneous Case

The contents of this chapter has been presented in Imsland et al. (2001b,a). The nominal results can be viewed as a preparation for the next chapter.

4.1 Introduction

Model predictive control (MPC), also referred to as moving horizon control or receding horizon control, has become an attractive feedback strategy, especially for linear or nonlinear systems subject to input and state constraints. In general, linear and nonlinear MPC are distinguished. Linear MPC refers to a family of MPC schemes in which linear models are used to predict the system dynamics, even though the dynamics of the closed loop system is nonlinear due to the presence of constraints. Linear MPC approaches have found successful applications, especially in the process industries (Qin and Badgwell, 1996). By now, linear MPC theory is fairly mature. Important issues such as the online computations, the interplay between modeling, identification and control as well as system theoretic issues like stability are well addressed.

Linear models are widely and successfully used to solve control problems. However, many systems are inherently nonlinear. Higher product quality specifications, increasing productivity demands, tighter environmental regulations and demanding economical considerations require systems to be operated closer to the boundary of the admissible operating region. Often in these cases, linear models are not adequate to describe the process dynamics and nonlinear models must be used. This motivates the application of nonlinear model predictive control.

Model predictive control for nonlinear systems (NMPC) has received considerable attention over the past years. Many theoretical and practical issues have been addressed. Several existing schemes guarantee stability under full state information, see Mayne et al. (2000), Allgöwer, Badgwell, Qin, Rawlings and Wright (1999), De Nicolao, Magni and Scattolini (2000) for recent reviews. In practice, however, not all states are directly available by measurements. A common approach is to still employ state feedback NMPC and to use a state observer to obtain an estimate of the system states used in the NMPC. If this approach is used, in general little can be said about the stability of the closed loop, since no universal separation principle for nonlinear systems exists.

Different approaches addressing the output feedback problem in NMPC exist. In Michalska and Mayne (1995) a moving horizon observer is presented, that together with the so-called dual-mode NMPC scheme (Michalska and Mayne, 1993) lead to semiglobal closed loop stability if no model-plant mismatch and disturbances are present. Semiglobal stability in this context means that for any subset of the region of attraction of the state feedback there exists a set of parameters (in Michalska and Mayne (1995) the sampling time and the enforced contraction rate of the observer error) such that this subset is contained in the region of attraction of the output feedback controller. However, for the results in Michalska and Mayne (1995) to hold it is required that a global (dynamic) optimization problem can be solved. In Magni, De Nicolao and Scattolini (1998), see also Scokaert et al. (1997), asymptotic stability for observer based discrete-time nonlinear MPC for “weakly detectable” systems is obtained. However, these results are of local nature in the sense that stability is guaranteed only for a sufficiently small initial observer error. While the region of attraction of the resulting output feedback controller in principle can be estimated from Lipschitz constants of the system, observer and controller it is not clear which parameters in the controller and observer must be changed to increase the resulting region of attraction of the output feedback controller.

This chapter is based on Imsland et al. (2001a), and considers the use of high-gain observers in conjunction with instantaneous NMPC. Instantaneous

NMPC in this context means that the solution to the open loop optimal control problem is assumed to be immediately available and implementable on the process at all time instances. Hence, the optimal input is not employed in a “sampled” fashion, as is often done in NMPC. We show that for a special MIMO system class, the resulting output feedback NMPC scheme does allow performance recovery of the state feedback NMPC controller as the observer gain increases. Performance recovery in this context means that the region of attraction and the rate of convergence of the output feedback scheme approach that of the state feedback scheme. Under additional technical conditions the resulting output feedback controller is robust with respect to static sector bounded nonlinear input uncertainties. The results are based on recently derived separation principles for the considered class of nonlinear systems (Atassi and Khalil, 1999, Teel and Praly, 1994, Esfandiari and Khalil, 1992).

The chapter is structured as follows: In Section 4.2 the class of systems is specified. Section 4.3 contains the description of the possible NMPC schemes for state feedback and presents the high-gain observer. In Section 4.4 the results on closed loop stability and performance for the nominal system are derived. Section 4.5 shows under some additional technical assumptions that the output feedback scheme is robust with respect to static sector bounded nonlinear input uncertainties. Some of the properties and practical implications of the presented approaches are discussed in Section 4.6. The proposed output feedback controller is applied in Section 4.7 to the control of an inverted pendulum on a cart.

In the following, $\|\cdot\|$ is the Euclidean vector norm in \mathbb{R}^n (where the dimension n follows from the context) or the associated induced matrix norm. The matrix $\text{blockdiag}(A_1, \dots, A_r)$ defines a block diagonal matrix with the matrices A_1, \dots, A_r on the “diagonal”, while $\text{diag}(\alpha_1, \dots, \alpha_r)$ is a diagonal matrix with the scalars $\alpha_1, \dots, \alpha_r$ on the diagonal. Whenever a semicolon “;” occurs in a function argument, the subsequent arguments are additional parameters, i.e. $f(x; \gamma)$ means the value of the function f at x with the parameter set to γ .

4.2 System class

This chapter considers the stabilization of nonlinear MIMO systems of the form

$$\dot{x}_1 = Ax_1 + B\phi(x, u) \quad (4.1a)$$

$$\dot{x}_2 = \psi(x, u) \quad (4.1b)$$

$$y = \begin{bmatrix} Cx_1 \\ x_2 \end{bmatrix} \quad (4.1c)$$

with $x(t) = (x_1(t), x_2(t))$. The system state consists of the vectors $x_1(t) \in \mathbb{R}^r$ and $x_2(t) \in \mathbb{R}^l$, and the vector $y(t) \in \mathbb{R}^{p+l}$ is the measured output. The control input is constrained, i.e. $u(t) \in \mathcal{U} \subset \mathbb{R}^m$, where

Assumption 4.1 $\mathcal{U} \subset \mathbb{R}^m$ is compact and the origin is contained in the interior of \mathcal{U} .

The $r \times r$ matrix A , $r \times p$ matrix B and the $p \times r$ matrix C have the following form

$$\begin{aligned} A &= \text{blockdiag}[A_1, A_2, \dots, A_p], & A_i &= \begin{bmatrix} 0 & 1 & 0 & \dots & 0 \\ 0 & 0 & 1 & \dots & 0 \\ \vdots & & & \ddots & \vdots \\ 0 & \dots & \dots & 0 & 1 \\ 0 & \dots & \dots & \dots & 0 \end{bmatrix}_{r_i \times r_i} \\ B &= \text{blockdiag}[B_1, B_2, \dots, B_p], & B_i &= \begin{bmatrix} 0 \\ \vdots \\ 0 \\ 1 \end{bmatrix}_{r_i \times 1} \\ C &= \text{blockdiag}[C_1, C_2, \dots, C_p], & C_i &= [1 \ 0 \ \dots \ 0]_{1 \times r_i}, \end{aligned}$$

i.e. the x_1 dynamics consists of p integrator chains of length r_i , with $r = r_1 + \dots + r_p$. Furthermore, the nonlinear functions ϕ and ψ satisfy

Assumption 4.2 The functions $\phi : \mathbb{R}^{r+l} \times \mathcal{U} \rightarrow \mathbb{R}^r$ and $\psi : \mathbb{R}^{r+l} \times \mathcal{U} \rightarrow \mathbb{R}^l$ are locally Lipschitz in their arguments over the domain of interest with $\phi(0, 0) = 0$ and $\psi(0, 0) = 0$. Additionally ϕ is bounded as function of x_1 .

One example of systems of this class are input affine nonlinear systems of the form

$$\dot{\zeta} = f(\zeta) + g(\zeta)u, \quad y = h(\zeta)$$

with full (vector) relative degree (r_1, r_2, \dots, r_p) , that is, $\sum_{i=1}^p r_i = \dim \zeta$. For this system class, it is always possible to find a coordinate transformation such that the system in the new coordinates fits the structure (4.1a) and (4.1c), see Isidori (1995).

4.3 NMPC output feedback controller: Setup

The proposed output feedback controller for the stabilization of the origin consists of a high-gain observer for estimating the states and an instantaneous state feedback NMPC controller.

4.3.1 State feedback NMPC

In the framework of predictive control, the value of the manipulated variable is given by the solution of an open loop optimal control problem. Herein, the open loop optimal control problem that defines the system input is given by

State feedback NMPC open loop optimal control problem:

Solve

$$\min_{\bar{u}(\cdot)} J(x(t), \bar{u}(\cdot); T_p) \quad (4.2)$$

subject to:

$$\dot{\bar{x}}_1 = A\bar{x}_1 + B\phi(\bar{x}, \bar{u}), \quad \bar{x}_1(0) = x_1(t) \quad (4.3a)$$

$$\dot{\bar{x}}_2 = \psi(\bar{x}, \bar{u}), \quad \bar{x}_2(0) = x_2(t) \quad (4.3b)$$

$$\bar{u}(\tau) \in \mathcal{U}, \quad \tau \in [0, T_p] \quad (4.3c)$$

$$\bar{x}(T_p) \in \mathcal{E} \quad (4.3d)$$

with the cost functional

$$J(x(t), \bar{u}(\cdot); T_p) := \int_0^{T_p} F(\bar{x}(\tau), \bar{u}(\tau)) d\tau + E(\bar{x}(T_p)). \quad (4.4)$$

The bar denotes internal controller variables and $\bar{x}(\cdot)$ is the solution of (4.3a)-(4.3b) driven by the input $\bar{u}(\cdot) : [0, T_p] \rightarrow \mathcal{U}$ over the prediction horizon T_p with initial condition $x(t)$. The stage cost $F(\bar{x}, \bar{u})$ satisfies

Assumption 4.3 $F : \mathbb{R}^{r+l} \times \mathcal{U} \rightarrow \mathbb{R}$ is continuous in all arguments with $F(0, 0) = 0$ and $F(x, u) > 0 \quad \forall (x, u) \neq (0, 0)$.

The constraint (4.3d) in the NMPC open loop optimal control problem forces the final predicted state to lie in the *terminal region* called \mathcal{E} and is thus often called *terminal region constraint*. In the cost functional J , the deviation from the origin of the final predicted state is penalized by the *terminal state penalty term* E .

Notice that for simplicity of exposition, only input constraints are considered (besides the terminal state constraint).

The optimal input signal resulting from the solution of the optimal control problem (4.2) is referred to by $\bar{u}^*(\cdot; x(t))$. The input applied to the system is given by

$$u(x(t)) := \bar{u}^*(\tau = 0; x(t)). \quad (4.5)$$

Thus the solution to the NMPC open loop optimal control problem must be available instantaneously at all times without delay. Such instantaneous NMPC formulations are often used (Mayne and Michalska, 1990, Mayne et al., 2000) for system theoretic investigations. However, obtaining an instantaneous solution of the dynamic optimization problem (4.2)-(4.3) is often not possible in practice. Instead, a sampled-data NMPC approach is often employed. The open-loop optimal control problem is only solved at discrete sampling instants and the resulting input signal is applied open loop until the next sampling instant. If the sampling intervals are short compared to the system dynamics, one would expect the trajectories of the sampled-data formulation to be close to the instantaneous implementation.

If T_p , E , F are suitably chosen, the origin of the nominal state feedback closed loop system with the input (4.5) is asymptotically stable and the region of attraction $\mathcal{R} \subset \mathbb{R}^{r+l}$ contains the set of states for which the open loop optimal control problem has a solution. In the following it is assumed, that

Assumption 4.4 *The instantaneous state feedback $u(x)$ is locally Lipschitz in x and asymptotically stabilizes the system (4.1) with a region of attraction \mathcal{R} .*

In principle this setup allows to consider a whole variety of different NMPC schemes (e.g. Chen and Allgöwer (1998b), Jadbabaie, Yu and Hauser (2001), see also Mayne et al. (2000) for a review). In this sense, the results described in the next sections can be seen as a special “separation” principle for NMPC using high-gain observers. The main restriction is the requirement that the optimal input must be locally Lipschitz.

4.3.2 High gain observer

The proposed (partial state) observer for the recovery of x_1 is a standard high-gain observer (Tornambè, 1992) of the following form

$$\dot{\hat{x}}_1 = A\hat{x}_1 + B\hat{\phi}((\hat{x}_1, x_2), u) + H(y_{x_1} - C\hat{x}_1),$$

where $H = \text{blockdiag}[H_1, \dots, H_p]$ with

$$H_i^\top = \left[\alpha_1^{(i)}/\epsilon, \alpha_2^{(i)}/\epsilon^2, \dots, \alpha_{r_i}^{(i)}/\epsilon^{r_i} \right]$$

and the $\alpha_j^{(i)}$ s are such that the roots of

$$s^{r_i} + \alpha_1^{(i)} s^{r_i-1} + \dots + \alpha_{r_i-1}^{(i)} s + \alpha_{r_i}^{(i)} = 0, \quad i=1, \dots, p$$

are in the open left half plane. The vector y_{x_1} is the first part of the measurement vector related to the states x_1 , i.e. $y_{x_1} = Cx_1$, and $\frac{1}{\epsilon}$ is the high-gain parameter. A, B, C and $\hat{\phi}$ are the same as in (4.1).

Only an observer for the x_1 states of the integrator chain is used, since the x_2 states are assumed to be directly measured.

Remark 4.1 *Notice that the use of an observer makes it necessary to define a (bounded) input also for estimated states that are outside the feasibility region \mathcal{R} of the controller. One possible choice is to fix the open loop input for $x \notin \mathcal{R}$ to an arbitrary value $u_f \in \mathcal{U}$: $u(x) = u_f, \forall x \notin \mathcal{R}$.*

4.4 Nominal output feedback NMPC using high-gain observers

In this section the nominal stability results for the proposed output feedback controller are derived, i.e. it is assumed that the plant and the model coincide ($\hat{\phi} = \phi$). It is shown that the performance of the state feedback controller can be recovered to any precision (see Definition 4.1) and that asymptotic stability can be achieved for a sufficiently small value of ϵ in the observer.

Consider the closed loop system given by (4.1a)-(4.1c) with the control given by the NMPC controller using the observed state \hat{x}_1 from the high-gain observer. In the following, recovery of the performance of the state feedback controller by the output feedback controller for the nominal system and for sufficiently small ϵ is established. We distinguish between the state trajectory resulting from the application of the state feedback controller and the state trajectory resulting from the application of the output feedback controller using the high-gain observer. Specifically, $x_{sf}(\cdot; x_0)$ is the trajectory resulting from the application of the state-feedback NMPC controller starting at $x_{sf}(0) = x_0$. The trajectory resulting from the application of the NMPC controlled based on the state estimates \hat{x}_1 starting from $x_\epsilon(0) = x_0$ and initializing the observer with $\hat{x}_1(0) = \hat{x}_{10} \in \mathcal{Q}$ is denoted by $x_\epsilon(\cdot; x_0, \hat{x}_{10})$. Here \mathcal{Q} is an arbitrary but fixed compact set of possible observer initial conditions. The suffix ϵ denotes the dependence on the value of the high gain parameter ϵ . Using this notation, the desired recovery of performance means:

Definition 4.1 [*Performance recovery with respect to ϵ*] Assume that $x_\epsilon(t; x_0)$ and $x_{sf}(t; x_0, \hat{x}_{10})$ start from the same initial state x_0 . Then, recovery of performance with respect to ϵ means that for any $\delta > 0$ there exists an ϵ^* such that for all $0 < \epsilon \leq \epsilon^*$,

$$\|x_\epsilon(t; x_0, \hat{x}_{10}) - x_{sf}(t; x_0)\| \leq \delta, \quad \forall t > 0, \quad \forall \hat{x}_{10} \in \mathcal{Q}.$$

Given this definition of performance recovery, the following theorem holds for the system controlled by the output feedback NMPC controller:

Theorem 4.1 Assume that Assumptions 4.1- 4.4 hold. Let \mathcal{S} be any compact set contained in the interior of \mathcal{R} . Furthermore, the observer initial condition satisfies $\hat{x}_1(0) = \hat{x}_{10} \in \mathcal{Q}$ with \mathcal{Q} arbitrary but fixed and compact. Then there exists a (sufficiently small) $\epsilon^* > 0$ such that for all $0 < \epsilon \leq \epsilon^*$ the closed loop system is asymptotically stable with a region of attraction of at least \mathcal{S} . Moreover, the performance of the state feedback NMPC controller is recovered in the sense of Definition 4.1.

Outline of Proof. The asymptotic stability follows from the proofs of Theorems 1, 2 and 4 in Atassi and Khalil (1999). The application of these theorems is possible due to the local Lipschitz property of the state feedback combined with the closed loop asymptotic stability. This make it possible to use converse Lyapunov arguments to assure the existence of a Lyapunov function for the state feedback closed loop, which is used in the proofs of the theorems. Theorem 1 in Atassi and Khalil (1999) guarantees boundedness of solutions starting in \mathcal{S} if $\epsilon < \epsilon_1^*$, with ϵ_1^* sufficiently small. Theorem 2 guarantees that the solutions starting in \mathcal{S} will enter any ball around the origin in finite time if $\epsilon < \epsilon_2^{*1}$, where ϵ_2^* is sufficiently small with $\epsilon_2^* < \epsilon_1^*$. Positioned in such a (small) ball, one can establish asymptotic stability for an $\epsilon_3^* < \epsilon_2^*$ as long as $\epsilon < \epsilon_3^*$, under the assumption $\phi_0 = \phi$. Furthermore, Theorem 3 in Atassi and Khalil (1999) shows that the trajectories of the controlled system using the observed state in the controller, converge uniformly to the trajectories of the controlled system using the true state in the controller, as $\epsilon \rightarrow 0$. Hence, for ϵ small enough, the trajectories (and hence the performance) of the state feedback NMPC are recovered. ■

The stability result derived is semiglobal, since for any compact subset \mathcal{S} of \mathcal{R} such a maximum value ϵ^* exists. In general, the closer the set \mathcal{S} approximates the set \mathcal{R} the smaller ϵ^* is. Note that the performance recovery of Theorem 4.1 also implies recovery of the rate of convergence of the state feedback controller for sufficiently small ϵ and convergence of the state and output feedback trajectories.

¹Note that ϵ_2^* depends on the size of the ball.

In the next section, the result on performance recovery will be expanded to systems having unknown but sector bounded nonlinear static input uncertainties.

4.5 Robustness to input uncertainties

The results derived so far are only valid in the nominal case. In this section we show that the proposed output feedback controller is robustly stable with respect to unknown but sector bounded input nonlinearities. The result uses the robustness of the separation principle presented in Atassi and Khalil (1999). To use this result it is necessary that the state feedback controller robustly exponentially stabilizes the system under the uncertainty. Thus in a first step, similarly to Magni and Sepulchre (1997), we show that the state feedback NMPC controller leads to exponential stability in the case of unknown static input uncertainties.

The uncertainty we consider consists of that the input applied to the system is subject to a static (unknown) input uncertainty $u_\Delta = \Delta(u)$ as shown in Figure 4.1, where $\Delta : \mathbb{R}^m \rightarrow \mathbb{R}^m$ has the structure $\Delta(u) = \text{diag}(\delta_1(u_1), \dots, \delta_m(u_m))$.

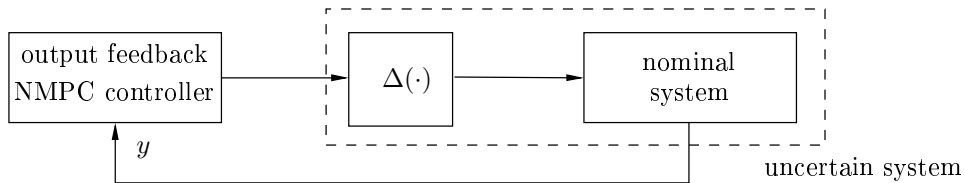

Figure 4.1: Closed loop with unknown static input nonlinearity

4.5.1 Nominal system class and assumptions on the NMPC state feedback controller

To derive the result we limit the considered system class and strengthen the conditions on the state feedback NMPC controller used. The system class considered in this section consists of input affine systems of the form:

$$\dot{x}_1 = Ax_1 + B\tilde{\phi}(x)u \quad (4.6a)$$

$$\dot{x}_2 = \tilde{\psi}_1(x) + \tilde{\psi}_2(x)u. \quad (4.6b)$$

The matrices A and B have the same form as in Section 4.2, and $\tilde{\phi}$, $\tilde{\psi}_1$ and $\tilde{\psi}_2$ have to satisfy similar assumptions as in the nominal case:

Assumption 4.5 *The functions $\tilde{\phi} : \mathbb{R}^{r+l} \rightarrow \mathbb{R}^{r \times m}$, $\tilde{\psi}_1 : \mathbb{R}^{r+l} \rightarrow \mathbb{R}^l$ and $\tilde{\psi}_2 : \mathbb{R}^{r+l} \rightarrow \mathbb{R}^{l \times m}$ are locally Lipschitz in x over the domain of interest with $\tilde{\phi}(0) = 0$ and $\tilde{\psi}_1(0) = 0$. Additionally $\tilde{\phi}$ is bounded as function of x_1 .*

System (4.6) will be referred to² by

$$\dot{x} = f(x) + g(x)u,$$

where $f(x) = [(Ax_1)^\top, (\tilde{\psi}_1(x))^\top]^\top$ and $g(x) = [(B\tilde{\phi}(x))^\top, (\tilde{\psi}_2(x))^\top]^\top$. With respect to the stage cost used in the NMPC controller we assume that

Assumption 4.6 *The stage cost in the NMPC controller is of the form*

$$F(x, u) = l(x) + u^\top R(x)u, \quad (4.7)$$

where $l(x) + u^\top R(x)u > c_F \|(x, u)\|_2^2$, $\forall (x, u) \in \mathbb{R}^{r+l} \times \mathcal{U}$ with $c_F > 0$, and $R(x) = \text{diag}(r_1(x), \dots, r_m(x))$.

Nominal exponential stability is guaranteed (see e.g. Jadbabaie et al. (2001)) by the following slightly strengthened assumption on the terminal region and terminal penalty term

Assumption 4.7 *Assume $E \in C^1$ is a proper F -compatible control Lyapunov function (CLF), i.e.*

$$\frac{\partial E}{\partial x} f(x, k(x)) + l(x) + k(x)^\top R(x)k(x) \leq 0, \quad \forall x \in \mathcal{E} \quad (4.8)$$

for some locally Lipschitz control law $k(x)$, and

$$c_{1E}\|x\|^2 \leq E(x) \leq c_{2E}\|x\|^2, \quad \forall x \in \mathcal{E}. \quad (4.9)$$

for some $c_{2E} > c_{1E} > 0$.

This assumption can for example be satisfied using the quasi-infinite horizon NMPC scheme (QIH-NMPC) as described in Chen and Allgöwer (1998b). As will be shown, this assumption is essential for robust exponential stability of the state feedback NMPC controller.

Since inverse optimality results are used to derive the robustness, it is necessary (Magni and Sepulchre, 1997) that the nominal open loop optimal control problem for the NMPC controller satisfies

²We have to consider the system class (4.6) since we use the high-gain observer outlined in Section 4.3.2. The robust exponential stability of the NMPC controller holds for general input affine systems.

Assumption 4.8 *The optimal control for the nominal system (4.6)*

$$u(x(t)) := \bar{u}^*(\tau = 0; x(t)).$$

is unconstrained in a (compact) region of interest. Further, the control is continuously differentiable, and the value function, defined by the optimal solution of the NMPC open loop optimal control problem

$$V(x; T_p) := J(x, \bar{u}^*(\cdot; x(t)); T_p)$$

is twice continuously differentiable.

Conditions ensuring that the value function is C^2 for unconstrained NMPC-controllers can (for example) be found in Jadbabaie et al. (2001).

4.5.2 Robust exponential stability of the state feedback NMPC controller

As stated in the following lemma the nominal state feedback NMPC controller robustly exponentially stabilizes the system if the input nonlinearity $\Delta(u)$ maps into the sector $(\frac{1}{2}, \infty)$ in the sense³

$$\frac{1}{2}s^\top s \leq s^\top \Delta(s) \leq \infty, \quad \forall s \in \mathbb{R}^m. \quad (4.10)$$

That is, the system has a *sector margin* $(\frac{1}{2}, \infty)$ (Sepulchre, Janković and Kokotović, 1997).

Lemma 4.1 *Let the assumptions of Theorem 4.1 and Assumptions 4.5-4.8 hold. If the input to the system is $\Delta(u^*(\tau = 0, x))$, and if $\Delta(\cdot)$ satisfies (4.10), then the origin of system (4.6) under the state feedback controller is exponentially stable.*

Proof. The proof is similar to the proof given in Sepulchre et al. (1997, Proposition 3.34) for *asymptotic* stability for general nonlinear optimal feedbacks, see also Glad (1987). For NMPC robust asymptotic stability results of this form have been derived in Magni and Sepulchre (1997) and in Chen and Shaw (1982). Thus, we have to show that under the given assumptions also robust *exponential* stability is achieved.

Under equivalent assumptions as used here, Magni and Sepulchre (1997) shows that the NMPC control law is inverse optimal, i.e. it is also optimal

³As the proof will reveal, more general $R(x)$ and $\Delta(\cdot)$ satisfying $u^\top R(x) [\Delta(u) - \frac{1}{2}u] \geq 0$ can be tolerated. This is not elaborated on here.

for a modified optimal control problem spanning over an infinite horizon with the cost function

$$\bar{J}(x, u(\cdot); \infty) = \int_0^\infty \bar{l}(x(\tau)) + u^\top(\tau)R(x(\tau))u(\tau)d\tau$$

where

$$\bar{l}(x) = l(x) - \frac{\partial}{\partial T_p}V(x; T_p).$$

Also the NMPC value function is the value function for the infinite horizon problem, i.e. $V(x; T_p) = \bar{V}(x; \infty)$ where \bar{V} is the value function associated with the cost \bar{J} . Due to this inverse optimality in the nominal case the NMPC state feedback control scheme has the same (asymptotic) robustness properties (stability margins) as infinite horizon optimal control (Magni and Sepulchre, 1997).

As noted in Magni and Sepulchre (1997), the optimal control can be written as $u^*(\tau = 0; x) = \gamma(x)$, where

$$\gamma(x) = -\frac{1}{2}R^{-1}(x) [V_x g(x)]^\top,$$

with $V_x := \frac{\partial V(x; T_p)}{\partial x}(x; T_p)$. Furthermore, the nominal system satisfies

$$V_x f(x) + V_x g(x)\gamma(x) = -\bar{l}(x) - \gamma^\top(x)R(x)\gamma(x).$$

For the “real” system with the unknown static input nonlinearity, \dot{V} is given by

$$\begin{aligned} \dot{V}(x; T_p) &= V_x f(x) + V_x g(x)\Delta(\gamma(x)) \\ &= V_x f(x) + V_x \gamma(x) + [V_x g(x)\Delta(\gamma(x)) - V_x g(x)\gamma(x)] \\ &= -\bar{l}(x) - \gamma^\top(x)R(x)\gamma(x) + [V_x g(x)\Delta(\gamma(x)) - V_x g(x)\gamma(x)] \\ &= -\bar{l}(x) + \left[V_x g(x)\Delta(\gamma(x)) - \frac{1}{2}V_x g(x)\gamma(x) \right] \\ &= -\bar{l}(x) - 2\gamma^\top(x)R(x) \left[\Delta(\gamma(x)) - \frac{1}{2}\gamma(x) \right]. \end{aligned}$$

Since $R(x)$ and $\Delta(x)$ are diagonal it follows that

$$\dot{V}(x; T_p) \leq -\bar{l}(x) = -l(x) + \frac{\partial}{\partial T_p}V(x; T_p).$$

Additionally, we know (Magni and Sepulchre, 1997) that $\frac{\partial}{\partial T_p}V(x; T_p) \leq 0$. Thus, using Assumption 4.6 yields

$$\dot{V}(x; T_p) \leq -l(x) \leq -c_F \|x\|^2. \quad (4.11)$$

Consequently, V is strictly decreasing along solution trajectories. Furthermore, for V to be a Lyapunov function showing exponential stability, it is required that V can be quadratically lower and upper bounded. Using Assumption 4.7 and Assumption 4.6 it is not hard to show that there exist constants $c_1 > 0$, $c_2 > 0$, $r > 0$ such that for all x with $\|x\| \leq r$,

$$c_1\|x\|^2 \leq V(x; T_p) \leq c_2\|x\|^2,$$

This, together with (4.11) implies that $V(x; T_p)$ is a valid Lyapunov function showing exponential stability. ■

Call the region of attraction for the state feedback closed loop with $\Delta(\cdot)$ for $\tilde{\mathcal{R}}$. In general, $\tilde{\mathcal{R}}$ will be different from \mathcal{R} , the nominal state feedback region of attraction. Any level sets given by $V(x) \leq c$, $c > 0$ contained in \mathcal{R} is an inner estimate of $\tilde{\mathcal{R}}$ since by the proof of the above lemma, $\dot{V}(x) \leq 0$ for all $x \in \mathcal{R}$.

4.5.3 Robust output feedback stability

Using Lemma 4.1, and the robustness of the observer to modeling errors in⁴ ϕ , one can adapt Theorem 5 in Atassi and Khalil (1999):

Theorem 4.2 *Assume that the assumptions of Theorem 4.1 and Assumptions 4.5- 4.8 hold. Then for any compact subset $\mathcal{S} \subset \tilde{\mathcal{R}}$ and for any observer initial condition that satisfies $\hat{x}_1(0) = \hat{x}_{10} \in \mathcal{Q}$ with \mathcal{Q} arbitrary but fixed and compact there exists an ϵ^* such that for $0 < \epsilon \leq \epsilon^*$ the system*

$$\begin{aligned} \dot{x}_1 &= Ax_1 + B\tilde{\phi}(x)\Delta(u) \\ \dot{x}_2 &= \tilde{\psi}_1(x) + \tilde{\psi}_2(x)\Delta(u) \\ y^\top &= [(Cx_1)^\top \quad x_2^\top] \end{aligned}$$

with

$$\frac{1}{2}s^\top s \leq s^\top \Delta(s) \leq \infty, \quad \forall s \in \mathbb{R}^m,$$

controlled by the output feedback NMPC scheme using the model given by (4.6) in the controller and observer and the cost (4.7) is exponentially stable and has a region of attraction of at least \mathcal{S} . Further, the performance of the state feedback NMPC controller is recovered in the sense of Definition 4.1.

Proof. Using Lemma 4.1 the proof follows from Atassi and Khalil (1999, Theorem 5). ■

⁴The modeling errors in ψ are not important for the estimation part, since the x_2 -states are measured.

4.6 Discussion of results

The presented results are based on the assumption that the NMPC controller is time continuous/instantaneous. In practice, it is of course not possible to solve the nonlinear optimization problem instantaneously. Instead, typically, the open loop optimal control problem will be solved only at certain sampling instants. The first part of the obtained control signal is then applied to the system until the next sampling instant. Also some time is needed to compute the solution of the optimal control problem, thus the computed control is based to some degree on old information, introducing delay in the closed loop. In practice this requires that the dynamics of the process is slow compared to the NMPC sampling interval and to the time needed to solve the optimization problem. A sampled data version of the given result, corresponding to the more “usual”, sampled NMPC setup is given in the next chapter.

As a consequence of the high-gain observer, in a transient phase the observed state may be outside the region where the NMPC optimization problem has a feasible solution (the peaking phenomenon). In this case the input should be assigned some fall-back value, as specified in Remark 4.1. The structure of the high-gain observer and the bounded inputs ensure (Atassi and Khalil, 1999) that ϵ can be chosen small enough so that the observer state converges to the true state before the true state leaves the region of attraction (and hence the feasibility area) of the NMPC controller. This follows from the assumption of bounded controls (Esfandiari and Khalil, 1992), which separates the peaking of the observer variables from the system.

It is assumed that the optimal control is Lipschitz in the initial state. In general, the solution of an optimal control problem (and hence, the state feedback defined in Assumption 4.4) can be non-Lipschitz in the initial values. In particular, it is known that NMPC can stabilize systems that are not stabilizable by continuous control (Fontes, 2000).

4.7 Illustrating example - control of an inverted pendulum

This section considers the control of an (unstable) inverted pendulum on a cart. The parameters and model equations of the cart-pendulum system are taken from Dussy and El Ghaoui (1996). Figure 4.2 schematically shows the inverted pendulum on a cart system. The angle of the pendulum with the vertical axis is z_1 . The input to the system is given by the force u which acts on the cart’s translation and is limited to $-10\text{N} \leq u(t) \leq 10\text{N}$. The control

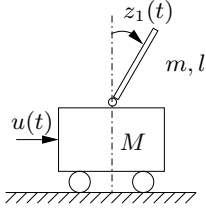

Figure 4.2: Inverted pendulum on a cart.

objective is to stabilize the angle $z_1 = 0$ (upright position) while the cart's position is not limited (and thus not modeled and controlled). It is assumed that only the angle z_1 but not the angular velocity can be measured directly. The model of the system is given by the following equations:

$$\begin{aligned} \dot{z}_1 &= z_2 \\ \dot{z}_2 &= \frac{ml \cos z_1 \sin z_1 z_2^2 - g(m + M) \sin z_1 + \cos z_1 \gamma u}{ml \cos^2 z_1 - \frac{4}{3}(m + M)l} \\ y &= z_1 \end{aligned}$$

where z_2 is the angular velocity of the pendulum. The parameters $M = 1\text{kg}$, $m = 0.2\text{kg}$, $l = 0.6\text{m}$ and $g = 10\frac{\text{m}}{\text{s}^2}$ are constant, whereas the “input gain” γ is uncertain (but constant) and satisfies $\gamma \in [1, 2]$. The nominal value of γ is 1. This model fits in the model class considered in Section 4.5 ($x_1 = [z_1, z_2]$, no x_2).

The stage cost is quadratic and unit weights are chosen on the states and input, i.e. $F(z, u) = z^\top \begin{bmatrix} 1 & 0 \\ 0 & 1 \end{bmatrix} z + u^2$. As state feedback QIH-NMPC is used. A quadratic upper bound E on the infinite horizon cost and a terminal region \mathcal{E} that satisfy the assumptions of Chen and Allgöwer (1998a) and with this the assumptions made in Section 4.3.1 are calculated using LMI/PLDI-techniques (Boyd et al., 1994). The piecewise linear differential inclusion (PLDI) representing the dynamics in a neighborhood of the origin is found using the methods described in Slupphaug et al. (2000). The resulting terminal penalty cost E is quadratic:

$$E(z) = z^\top \begin{bmatrix} 311.31 & 66.20 \\ 66.20 & 34.99 \end{bmatrix} z,$$

and the terminal region \mathcal{E} is given by $\mathcal{E} = \{z \in \mathbb{R}^2 | E(z) \leq 20\}$. The control horizon T_p is 0.5s. In Figure 4.3 the region of attraction and the contour lines of the value function of the state feedback NMPC controller are

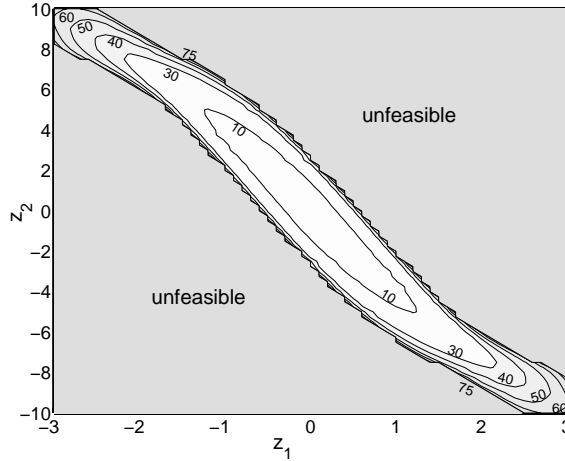

Figure 4.3: Level sets of the quasi infinite horizon state feedback NMPC controller value function.

shown. These results are obtained solving the open loop state feedback NMPC problem for different initial conditions of z_1 and z_2 . In the output feedback case, whenever the state estimate leaves the region of attraction of the state feedback QIH-NMPC scheme (i.e. there is no solution to the open loop optimization problem) the input is set to 0, compare Remark 4.1.

The states z_1 and z_2 are estimated from y using the described high-gain observer. The observer parameters α_1 and α_2 are chosen to $\alpha_1 = 2$ and $\alpha_2 = 1$. For all subsequent simulations the observer is started with zero initial conditions, i.e. $\hat{z}_1 = \hat{z}_2 = 0$.

Figure 4.4 shows the phase plot of the system states and the observer states of the closed loop system for different values of ϵ for $\gamma = 1$ (nominal system). As expected, for decreasing values of ϵ the trajectories of the state feedback control scheme are recovered. Figure 4.5 shows the corresponding trajectories of the observer states. Comparing both plots one sees that for $\epsilon = 0.1$, when the observer state and the real state are at the boundary of the region of attraction of the state feedback controller, a small estimation error does lead to infeasibility of the open loop problem and thus to divergence. For smaller values of ϵ the correct state is recovered faster and infeasibility/divergence are avoided. However, for smaller values of ϵ a bigger (but time-wise shorter) peaking of the observer error at the beginning occurs, see Figure 4.5. This is also evident in the time plot of the states and inputs as shown in Figure 4.6 and the time plot of the observer error, see Figure 4.7.

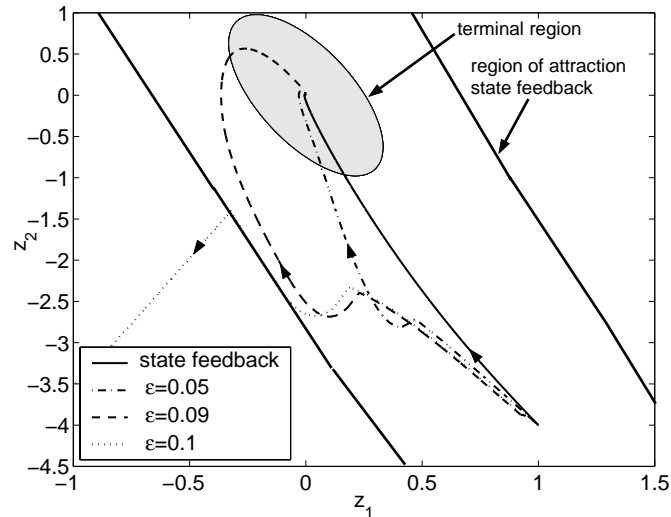

Figure 4.4: Phase plot of the nominal system states for $\gamma = 1$.

Notice also that in the state feedback case for the initial conditions shown the input constraints are not hit, while for all output feedback cases the NMPC controller hits the input constraints.

To show the robustness with respect to sector bounded input nonlinearities, Figure 4.8 shows the trajectories of the closed loop system for a value of $\gamma = 2$. In this case, the observer and NMPC controller use the nominal value of $\gamma_{nom} = 1$. The controller is still able to stabilize the system despite the gain uncertainty, however the performance degrades.

The given example underpins the derived results on the recovery of the region of attraction and performance as well as the robustness for the high-gain observer based NMPC strategy. As shown, for a too slow high-gain observer the closed loop trajectories may diverge from a given initial condition. However, sufficiently small values of ϵ do lead to closed loop stability and satisfying recovery of performance.

4.8 Conclusions

Nonlinear model predictive control has received considerable attention during the past decades. However, no significant progress with respect to the output feedback case has been made. The existing solutions are either of local nature (Scokaert et al., 1997, Magni et al., 1998) or difficult to imple-

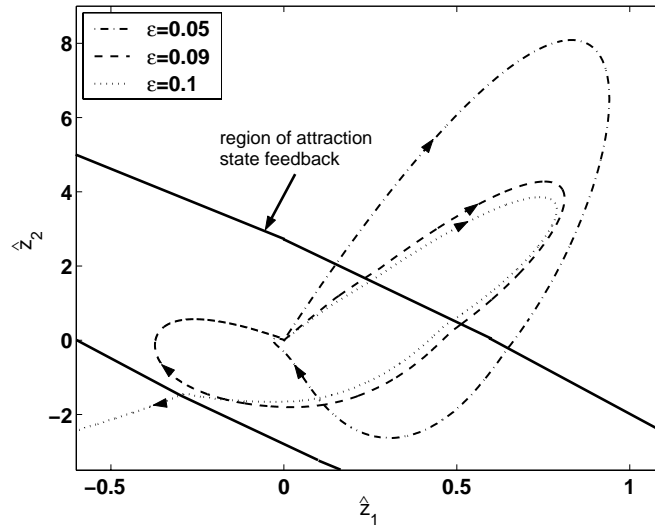
Figure 4.5: Phase plot of the observer states for $\gamma = 1$.

ment (Michalska and Mayne, 1995). By using results from Atassi and Khalil (1999), it is demonstrated that semiglobal stability results on a bounded region of attraction and recovery of performance can be achieved using NMPC and a suited high-gain observer for a class of systems. Furthermore, it is shown that the proposed output feedback NMPC controller is robust with respect to sector bounded input nonlinearities. The main restrictions of the scheme are the special system structure assumed, that the NMPC controller must be implemented instantaneously, and that the optimal input of the NMPC controller must be locally Lipschitz as a function of the state. However, note that in Chapter 5 the system class is expanded, and the same expansion is in principle valid for the results in this chapter. From a practical perspective, one should additionally note the inherent problem of high gain observers with respect to measurement noise, which may restrict the applicability.

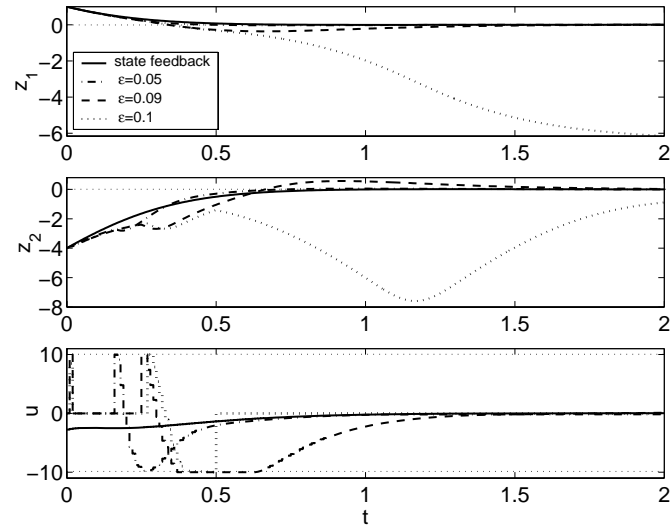

Figure 4.6: Trajectories of z_1 , z_2 and the input u .

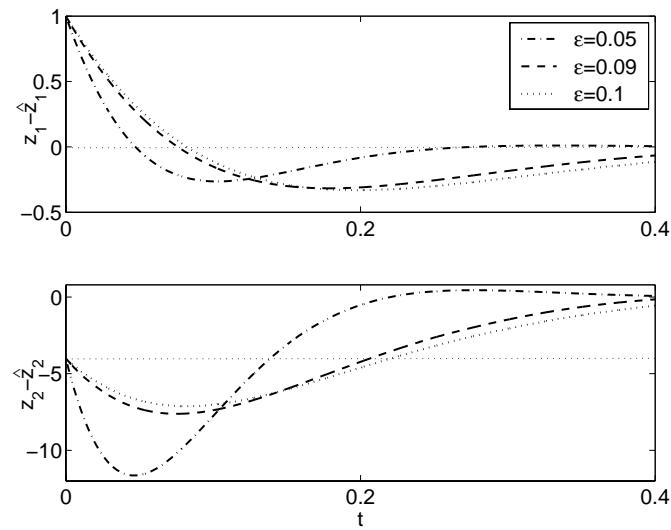

Figure 4.7: Trajectories of the observer error.

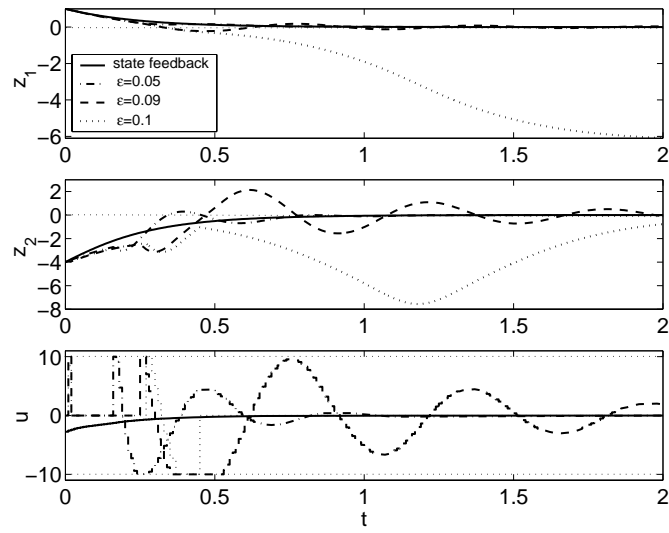

Figure 4.8: Trajectories z_1 , z_2 and u in case of input uncertainty ($\gamma = 2$).

Chapter 5

Output Feedback Nonlinear Model Predictive Control - Stability and Performance

While the previous chapter used an instantaneous implementation of NMPC, this chapter considers the more usual sampled-data implementation. A preliminary version of some of the results of this chapter is contained in Findeisen et al. (2002a). The main result (the practical stability result, Section 5.4) is submitted for journal publication (Findeisen et al., 2002b), while the convergence result of Section 5.5 can be found in Imsland et al. (2002).

5.1 Introduction

This chapter is concerned with the output feedback stabilization problem for uniformly completely observable continuous time systems where the control is given by a nonlinear model predictive control (NMPC) scheme. To obtain an output feedback control scheme that achieves semi-global practical stability, we propose to use a (fast enough) high-gain observer for state recovery in combination with a sampled-data NMPC controller. While the high-gain observer operates continuously, the sampled-data state feedback NMPC controller delivers a new optimal input trajectory only at discrete sampling instants. This input is then applied open-loop until the next sampling instant.

Model predictive control for systems described by nonlinear ODEs or difference equations has received considerable attention over the past years. Several schemes that guarantee stability in the state feedback case exist by

now, see for example Mayne et al. (2000), Allgöwer et al. (1999), De Nicolao et al. (2000) for recent reviews. Fewer results are available in the case when not all states are directly measured. To overcome this problem, often a state observer is used together with the stabilizing state feedback NMPC controller. However, due to the lack of a general nonlinear separation principle, care has to be taken regarding the stability of the resulting closed loop.

Several researchers have addressed the output feedback problem in NMPC. In Michalska and Mayne (1995) an optimization based moving horizon observer combined with the NMPC scheme proposed in Michalska and Mayne (1993) is shown to lead to (semi-global) closed-loop stability. For the results to hold, it is assumed that no model-plant mismatch and no disturbances are present, and a global optimization problem for the moving horizon observer must be solved. The approach in de Oliveira Kothare and Morari (2000) derives local uniform asymptotic stability of contractive NMPC in combination with a “sampled” state estimator. In Magni et al. (1998), Magni, De Nicolao and Scattolini (2001), see also Scokaert et al. (1997), asymptotic stability results for observer based discrete-time NMPC for “weakly detectable” systems are given. For these approaches (Magni et al., 1998, 2001, Scokaert et al., 1997) it is in principle possible to estimate a (local) region of attraction of the resulting output feedback controller from Lipschitz constants of the system, controller and observer. However, it is in general not clear which parameters in the controller and observer should be changed to increase the region of attraction, or how to recover (in the limit) the region of attraction of the state feedback controller. This problem has been addressed in Imsland et al. (2001a) (see Chapter 4) and in Findeisen et al. (2002a). In Imsland et al. (2001a) semi-global practical stability of instantaneous NMPC using high-gain observers has been established. These results were expanded in Findeisen et al. (2002a) to sampled-data NMPC.

The main difference to the results presented in Imsland et al. (2001a) lies in the fact that we consider NMPC schemes that implement open-loop input signals between the sampling instants instead of an instantaneous implementation. Furthermore, we expand the system class. The systems considered in this chapter are assumed to be uniformly completely observable, whereas in Findeisen et al. (2002a) we assume the system to have full vector relative degree and to be in Byrnes-Isidori normal form.

With respect to the general output feedback stabilization problem for nonlinear systems, significant progress has been achieved recently. Based on output feedback results for fully input-output linearizable systems (Esfandiari and Khalil, 1992) different versions of the so-called nonlinear separation principle for a rather wide class of systems have been established, see for example Teel and Praly (1995), Atassi and Khalil (1999), Maggiore and

Passino (2001). All these approaches use a high-gain observer for state recovery. High-gain observers have the advantage that one “tuning-knob”, the so-called high-gain parameter, for speed of convergence of the observer error exists. Decreasing the high-gain parameter allows to achieve any desired rate of convergence and to reach any desired bounded set for the observer error in finite time. The observer error is then considered as a disturbance in the state feedback controller and stability of the closed loop can be established. While the initial results covered control laws that are locally Lipschitz in the state, recent advances (Shim and Teel, 2001b,a) have achieved output feedback stabilization using discontinuous control laws for systems that are not uniformly completely observable and that cannot be stabilized by continuous feedback.

In deriving the results, we are inspired by the nonlinear separation principles presented in Teel and Praly (1995), Atassi and Khalil (1999), that is, we propose to use continuous time high-gain observers in combination with NMPC. The main difference to these results lies in the fact that we want to employ an NMPC controller that only recalculates the optimal input signal at sampling instants, as is customary in the NMPC literature. Between the sampling instants, the input signal is applied open-loop to the system. We show that for uniformly completely observable nonlinear MIMO systems we can achieve semi-global practical stability using this approach. This means, that for any desired subset of the region of attraction of the state feedback NMPC and any small region containing the origin, there exists a sampling period and an observer gain such that in the output feedback case, all states starting in the desired subset will converge in finite time to the small region containing the origin and remain there. Moreover, under some restrictive assumptions, we show that the states will converge to the origin. To prove the results we will use the decrease-property of the value function of the NMPC state feedback controller, since we cannot make use of standard converse Lyapunov results for continuous time systems.

Our results differ from the general nonlinear separation principle results presented in Shim and Teel (2001a,b) in the sense that the input signal between the sampling instants is defined by the NMPC controller and is not fixed to a constant value. On the other hand, we do not consider systems that can be stabilized only by discontinuous feedback or that are not uniformly observable, as done in Shim and Teel (2001a,b).

The results are not focused on one specific NMPC approach. Instead, they are based on a series of assumptions that in principle can be satisfied by several NMPC schemes, such as quasi-infinite horizon NMPC (Chen and Allgöwer, 1998b), zero terminal constraint NMPC (Mayne and Michalska, 1990) and NMPC schemes using control Lyapunov functions to obtain

stability (Jadbabaie et al., 2001, Primbs, Nevistić and Doyle, 1999). One drawback is that for the full state estimation input derivatives might appear in the observer equations. Then the NMPC state feedback must be modified to provided sufficiently “smooth” inputs. If no input derivatives appear in the observer, no changes in the state feedback NMPC controller are necessary and it can be argued that in this case, the derived results are a special separation principle for NMPC.

The chapter is structured as follows: In Section 5.2 we briefly state the considered system class and the observability assumption. Section 5.3 contains a description of the proposed output feedback NMPC scheme. It consists of an NMPC state feedback controller and a high-gain observer for state recovery. In Section 5.4 we present the main results. First we show boundedness of the states, then we prove semi-global practical stability of the closed loop system states. Under strengthened assumptions and for a limited system class, convergence of observer error and system states to the origin is shown in Section 5.5.

In the following $\|\cdot\|$ is the Euclidean vector norm in \mathbb{R}^n (where the dimension n follows from the context) or the associated induced matrix norm. The operator $\text{blockdiag}(A_1, \dots, A_r)$ defines a block diagonal matrix with the matrices A_1, \dots, A_r on the “diagonal”, while $\text{diag}(\alpha_1, \dots, \alpha_r)$ is a diagonal matrix with the scalars $\alpha_1, \dots, \alpha_r$ on the diagonal.

5.2 System class and observability assumptions

We consider nonlinear continuous time MIMO systems of the form

$$\dot{x} = f(x, u), \tag{5.1a}$$

$$y = h(x, u) \tag{5.1b}$$

where $x \in \mathcal{X} \subset \mathbb{R}^n$ is the system state constrained to the set \mathcal{X} , and the measured output is $y \in \mathbb{R}^p$. The control input u is constrained to $u \in \mathcal{U} \subset \mathbb{R}^m$. We assume that the functions $f : \mathbb{R}^n \times \mathcal{U} \rightarrow \mathbb{R}^n$ and $h : \mathbb{R}^n \times \mathcal{U} \rightarrow \mathbb{R}^p$ are smooth, and that $f(0, 0) = 0$ and $h(0, 0) = 0$, that is, the origin is an equilibrium.

The control objective is to derive an output feedback control scheme that (practically) stabilizes the system while satisfying the constraints on the states and inputs. With respect to \mathcal{X} and \mathcal{U} we assume that

Assumption 5.1 $\mathcal{U} \subset \mathbb{R}^m$ is compact, $\mathcal{X} \subseteq \mathbb{R}^n$ is connected and $(0, 0) \in \mathcal{X} \times \mathcal{U}$.

NMPC requires full state information for prediction. Since not all states are available via output measurements, we use a high-gain observer to recover the states. The assumed observability properties of the system (5.1) are characterized in terms of the observability map \mathcal{H} , which is defined via successive differentiation of the output y :

$$Y := \begin{bmatrix} y_1 \\ \dot{y}_1 \\ \dots \\ y_1^{(r_1)} \\ y_2 \\ \dots \\ y_p \\ \dot{y}_p \\ \dots \\ y_p^{(r_p)} \end{bmatrix} = \begin{bmatrix} h_1(x, u) \\ \psi_{1,1}(x, u, \dot{u}) \\ \vdots \\ \psi_{1,r_1}(x, u, \dot{u}, \dots, u^{(r_1)}) \\ h_2(x, u) \\ \vdots \\ h_p(x, u) \\ \psi_{p,1}(x, u, \dot{u}) \\ \vdots \\ \psi_{p,r_p}(x, u, \dot{u}, \dots, u^{(r_p)}) \end{bmatrix} =: \mathcal{H}(x, U).$$

Here $\sum_{i=1}^p (r_i + 1) = n$, and $U = [u_1, \dot{u}_1, \dots, u_1^{(m_1)}, u_2, \dot{u}_2, \dots, u_m, \dot{u}_m, \dots, u_m^{(m_m)}]^\top \in \mathbb{R}^{m_U}$ where m_i is the number of really necessary derivatives of input i and where $m_U := \sum_{i=1}^m (m_i + 1)$. The $\psi_{i,j}$'s are defined via successive differentiation of y

$$\psi_{i,0}(x, u) = h_i(x, u), \quad i = 1, \dots, p \quad (5.2a)$$

$$\psi_{i,j}(x, u, \dots, u^{(j)}) = \frac{\partial \psi_{i,j-1}}{\partial x} \cdot f(x, u) + \sum_{k=1}^j \frac{\partial \psi_{i,j-1}}{\partial u^{(k-1)}} \cdot u^{(k)}, \quad \begin{array}{l} i = 1, \dots, p, \\ j = 1, \dots, r_p. \end{array} \quad (5.2b)$$

In general, not all u_i derivatives up to order $\max\{r_1, \dots, r_p\}$ appear in $\psi_{i,j}$. For example if $h_1(x) = x_1$, $\psi_{1,1}$ can only depend on u and not on the derivative of u . Given these definitions we can state the uniform complete observability property that we assume in this chapter (Tornambè, 1992, Teel and Praly, 1994).

Assumption 5.2 (Uniform Complete Observability) *The system (5.1) is uniformly completely observable in the sense that there exists a set of indices $\{r_1, \dots, r_p\}$ such that the mapping defined by $Y = \mathcal{H}(x, U)$ is smooth with respect to x and its inverse from Y to x is smooth and onto for any U .*

The inverse of \mathcal{H} with respect to x is written $\mathcal{H}^{-1}(Y, U)$, that is $x = \mathcal{H}^{-1}(Y, U)$.

Remark 5.1 *In general the set of indices $\{r_1, \dots, r_p\}$ is not unique, different \mathcal{H} might exist. One can use this degree of freedom to find a \mathcal{H} such that only a minimum number of derivatives of u , possibly none, are necessary. This is desirable, since all inputs u and all the derivatives of u that appear in U must be known. This is discussed in more detail in Section 5.3.2.*

No explicit stabilizability assumption is required to hold. The stabilizability is implicitly ensured by the assumption on the NMPC controller to have a non-trivial region of attraction (see Section 5.3.1).

5.3 Output feedback NMPC controller

The output feedback control scheme consists of a state feedback NMPC controller and a high-gain observer for state recovery. While the optimal inputs are only recalculated at the sampling instants and are applied open-loop in-between, the high-gain observer operates continuously.

5.3.1 NMPC “open-loop” state feedback

In the framework of predictive control, the input is defined by the solution of an open-loop optimal control problem that is solved at the sampling instants. In between the sampling instants the optimal input is applied open-loop. The sampling instants t_i satisfy $t_i - t_{i-1} = \delta$, δ being the sampling period. For a given t , t_i should be taken as the nearest sampling instant $t_i < t$. The open-loop optimal control problem solved at any t_i is given by:

$$\min_{\bar{u}(\cdot)} J(\bar{u}(\cdot); x(t_i)) \quad (5.3a)$$

$$\text{subject to: } \dot{\bar{x}}(\tau) = f(\bar{x}(\tau), \bar{u}(\tau)), \quad \bar{x}(\tau = 0) = x(t_i) \quad (5.3b)$$

$$\bar{u}(\tau) \in \mathcal{U}, \quad \bar{x}(\tau) \in \mathcal{X} \quad \tau \in [0, T_p] \quad (5.3c)$$

$$\bar{x}(T_p) \in \mathcal{E}. \quad (5.3d)$$

The cost functional J is defined over the control horizon T_p by

$$J(\bar{u}(\cdot); x(t_i)) := \int_0^{T_p} F(\bar{x}(\tau), \bar{u}(\tau)) d\tau + E(\bar{x}(T_p)).$$

The bar denotes internal controller variables, $\bar{x}(\cdot)$ is the solution of (5.3b) driven by the input $\bar{u}(\cdot) : [0, T_p] \rightarrow \mathcal{U}$ with the initial condition $x(t_i)$. The solution to the optimal control problem is written $\bar{u}^*(\cdot; x(t_i))$. This input is open-loop applied to the system until the next sampling instant t_i ,

$$u(t; x(t_i)) = \bar{u}^*(t - t_i; x(t_i)), \quad t \in [t_i, t_i + \delta). \quad (5.4)$$

The control $u(t; x(t_i))$ is a feedback, since it is recalculated at each sampling instant using new state measurements.

Remark 5.2 *The cost minimized over the control horizon T_p is defined by the stage cost F and the terminal penalty E . Both are in general continuous functions of their arguments and positive definite. The terminal constraint (5.3d) in the NMPC open-loop optimal control problem forces the final predicted state at time $\tau = T_p$ to lie in the terminal region \mathcal{E} . The end penalty E and the terminal region constraint are typically added to the state feedback NMPC problem to enforce stability of the closed loop.*

We do not go into any details about the different existing state feedback NMPC schemes that guarantee stability, see for example Mayne et al. (2000), Allgöwer et al. (1999) for recent reviews. Instead we state the set of assumptions we require to achieve semi-global practical stability in the output feedback case.

Assumption 5.3 *There exists a simply connected region $\mathcal{R} \subseteq \mathcal{X} \subseteq \mathbb{R}^n$ (region of attraction of the state feedback NMPC) with $0 \in \mathcal{R}$ such that:*

1. **Stage cost is lower bounded by a \mathcal{K} function:**

The stage cost $F : \mathcal{R} \times \mathcal{U} \rightarrow \mathbb{R}$ is continuous, satisfies $F(0, 0) = 0$, and is lower bounded by a class \mathcal{K} function α_F

$$\alpha_F(\|x\| + \|u\|) \leq F(x, u) \quad \forall (x, u) \in \mathcal{R} \times \mathcal{U}.$$

2. **Optimal control is uniformly locally Lipschitz in terms of the initial state:**

The optimal control $\bar{u}^(\tau; x)$ is piecewise continuous and locally Lipschitz in x in \mathcal{R} , uniformly in τ . That is, for a given compact set $\Omega \subseteq \mathcal{R}$*

$$\|\bar{u}^*(\tau; x_1) - \bar{u}^*(\tau; x_2)\| \leq L_u \|x_1 - x_2\| \quad \forall \tau \in [0, T_p), x_1, x_2 \in \Omega,$$

where L_u is the Lipschitz constant of $\bar{u}^(\tau; x)$ (as a function of x) in Ω .*

3. **Value function is locally Lipschitz:**

The value function, which is defined as the optimal value of the cost for every $x \in \mathcal{R}$

$$V(x) := J(\bar{u}^*(\cdot; x); x)$$

is Lipschitz for all compact subsets of \mathcal{R} and $V(0) = 0$, $V(x) > 0$ for all $x \in \mathcal{R}/\{0\}$.

4. *Decrease of the value function along solution trajectories starting at sampling instants t_i :*

Along solution trajectories starting at a sampling instant t_i at $x(t_i) \in \mathcal{R}$, the value function satisfies

$$V(x(t_i + \tau)) - V(x(t_i)) \leq - \int_{t_i}^{t_i + \tau} F(x(s), u(s; x(s_i))) ds, \quad 0 \leq \tau.$$

Assumptions 5.3.1 and 5.3.4 are satisfied by various NMPC schemes, such as quasi-infinite horizon NMPC (Chen and Allgöwer, 1998b), zero terminal constraint NMPC (Mayne and Michalska, 1990), and NMPC schemes using control Lyapunov functions to achieve stability (Jadbabaie et al., 2001, Primbs et al., 1999). Assumption 5.3.1 is a typical assumption in NMPC, often quadratic stage cost functions F are used. Assumption 5.3.4 implies that \mathcal{R} is invariant under the state feedback NMPC for all trajectories starting at t_i in \mathcal{R} . It also implies convergence of the state to the origin for $t \rightarrow \infty$ (Chen and Allgöwer, 1998b, Chen, 1997) and allows the use of suboptimal NMPC schemes (Mayne et al., 2000, Scokaert, Mayne and Rawlings, 1999). The strongest assumptions are Assumptions 5.3.2 and 5.3.3. For existing NMPC schemes Assumption 5.3.2 is often satisfied near the origin. In words, this (quite frequently made) assumption requires that two “close” initial conditions must lead to “close” optimal input trajectories. This does not exclude piecewise continuous input signals as is often used in NMPC. However, for example, it excludes systems that can only be stabilized by discontinuous feedback (as state feedback NMPC can stabilize (Fontes, 2000)). Checking Assumption 5.3.2 and 5.3.3 a priori is in general difficult.

To establish the stability results of this chapter, it is necessary that for any compact subset $\mathcal{S} \subset \mathcal{R}$ we can find a compact outer approximation $\Omega_c(\mathcal{S})$ that contains \mathcal{S} and is invariant under the NMPC state feedback.

Assumption 5.4 *For all compact sets $\mathcal{S} \subset \mathcal{R}$ there is at least one compact set $\Omega_c(\mathcal{S}) = \{x \in \mathcal{R} | V(x) \leq c\}$ such that $\mathcal{S} \subset \Omega_c(\mathcal{S})$.*

In general, more than one such set exists, since c can be in the range $\sup_{x \in \mathcal{R}} V(x) > c \geq \max_{x \in \mathcal{S}} V(x)$. The existence assumption of such a set $\Omega_c(\mathcal{S})$ for all compact sets \mathcal{S} of \mathcal{R} is strong. If it is not fulfilled, the results are limited to sets \mathcal{S} that are contained in the largest level set $\Omega_c \subset \mathcal{R}$.

5.3.2 State recovery by high-gain observers

The NMPC state feedback controller requires full state information. We propose to recover the state from output (and input) information via a high-gain observer. We briefly outline the basic structure of the high-gain observer

used. Furthermore, we present two possibilities to avoid the need for analytic knowledge of the inverse of the observability map, $\mathcal{H}^{-1}(Y, U)$, for which an analytic expression is often difficult to obtain. Since explicit knowledge and boundedness of the u derivatives that appear in the observability map is necessary, we also briefly comment on this issue at the end of this section.

Basic high-gain observer structure

Application of the coordinate transformation $\zeta := \mathcal{H}(x, U)$ to the system (5.1) leads to the system in observability normal form in ζ coordinates

$$\begin{aligned}\dot{\zeta} &= A\zeta + B\phi(\zeta, \tilde{U}), \\ y &= C\zeta.\end{aligned}$$

The matrices A , B and C have the following structure

$$\begin{aligned}A &= \text{blockdiag}[A_1, A_2, \dots, A_p], & A_i &= \begin{bmatrix} 0 & 1 & 0 & \dots & 0 \\ 0 & 0 & 1 & \dots & 0 \\ \vdots & & & & \vdots \\ 0 & \dots & \dots & 0 & 1 \\ 0 & \dots & \dots & \dots & 0 \end{bmatrix}_{r_i \times r_i} \\ B &= \text{blockdiag}[B_1, B_2, \dots, B_p], & B_i &= [0 \quad \dots \quad 0 \quad 1]_{r_i \times 1}^\top \\ C &= \text{blockdiag}[C_1, C_2, \dots, C_p], & C_i &= [1 \quad 0 \quad \dots \quad 0]_{1 \times r_i},\end{aligned}$$

and ϕ is given by

$$\phi(\zeta, \tilde{U}) = \begin{bmatrix} \psi_{1, r_1+1}(\mathcal{H}^{-1}(\zeta, U), u, \dots, u^{(r_1+1)}) \\ \vdots \\ \psi_{p, r_p+1}(\mathcal{H}^{-1}(\zeta, U), u, \dots, u^{(r_p+1)}) \end{bmatrix}. \quad (5.6)$$

The functions ψ_{i, r_j+1} , $j = 1, \dots, p$ are defined analogously to (5.2). The vector \tilde{U} contains, similarly to U in the mapping \mathcal{H} , the input and all necessary derivatives. It is necessary to distinguish between \tilde{U} and U , since, as can be seen from (5.6), \tilde{U} might contain more u derivatives than U . Note that ϕ is locally Lipschitz in all arguments since f and h are locally Lipschitz and \mathcal{H} is smooth. The high-gain observer¹

$$\dot{\hat{\zeta}} = A\hat{\zeta} + H_\epsilon(y - C\hat{\zeta}) + B\hat{\phi}(\hat{\zeta}, \tilde{U}) \quad (5.7)$$

allows recovery of the states ζ from $y(t)$ (and \tilde{U}) (Tornambè, 1992, Atassi and Khalil, 1999). The function $\hat{\phi}$ is normally given by the nominal model of ϕ , i.e. in principle $\hat{\phi} = \phi$ if ϕ is known exactly. If ϕ is not known exactly, one could also take $\hat{\phi} = 0$. The key assumption we make on $\hat{\phi}$ in comparison to ϕ is that

¹In the following $\hat{\cdot}$ denotes variables and functions used in the observer.

Assumption 5.5 $\hat{\phi}$ is globally bounded.

Ideally one would like to use $\hat{\phi} = \phi$, if ϕ is bounded and known, since one can expect good observer performance in this case. If ϕ is not globally bounded one can generate a suitable $\hat{\phi}$ by bounding ϕ outside a region of interest. In the extreme case, i.e. if ϕ is not or only very roughly known, Assumption 5.5 also allows to choose $\hat{\phi} = 0$.

The observer gain matrix H_ϵ is given by $H_\epsilon = \text{blockdiag}[H_{\epsilon,1}, \dots, H_{\epsilon,p}]$, with $H_{\epsilon,i}^\top = [\alpha_1^{(i)}/\epsilon, \alpha_2^{(i)}/\epsilon^2, \dots, \alpha_{r_i}^{(i)}/\epsilon^{r_i}]$, where ϵ is the so-called high-gain parameter since $1/\epsilon$ goes to infinity for $\epsilon \rightarrow 0$. The $\alpha_j^{(i)}$'s are design parameters and must be chosen such that the polynomials

$$s^{r_i} + \alpha_1^{(i)} s^{r_i-1} + \dots + \alpha_{r_i-1}^{(i)} s + \alpha_{r_i}^{(i)} = 0, \quad i = 1, \dots, p$$

are Hurwitz. Assuming that the system state is bounded, and that Assumption 5.5 holds, it is possible to show that for any desired maximum observer error there exists a sufficiently small ϵ such that the observer error starting in any compact set satisfies in finite time the desired bound (Atassi and Khalil, 1999). Note that global boundedness of $\hat{\phi}$ can always be achieved by saturating $\hat{\phi}$ outside a compact set of interest.

The state estimate used in the NMPC controller is obtained at the sampling instants t_i by

$$\hat{x}(t_i) := \mathcal{H}^{-1}(\hat{\zeta}(t_i^-), U(t_i; \hat{x}(t_{i-1}))). \quad (5.8)$$

Here $U(t_i; \hat{x}(t_{i-1}))$ contains the input and its derivatives obtained by the NMPC controller at time t_{i-1} for the time t_i . The variable t_i^- denotes the left limit of the corresponding trajectory for t_i . It is necessary to distinguish between the left limit t_i^- and the value at t_i since \mathcal{H} depends on u and its derivatives leading to possible discontinuities in the state estimate, as discussed in some more detail in Section 5.3.3. The high-gain observer allows to recover the full state information. However, the inverse mapping \mathcal{H}^{-1} must be known explicitly. Furthermore the expanded input vector \tilde{U} must always, not only at sampling instants, be known.

Avoiding explicit knowledge of \mathcal{H}^{-1}

One way to avoid explicit knowledge of \mathcal{H}^{-1} and \tilde{U} is to set $\hat{\phi} = 0$. The observer is then given by

$$\dot{\hat{\zeta}} = A\hat{\zeta} + H_\epsilon(y - C\hat{\zeta}).$$

In this case the observer error still converges to any desired bound for a sufficiently small ϵ . However, the performance for a fixed ϵ might degrade

significantly. The key advantage is that the inverse of the observability map \mathcal{H} , as well as information on U is only necessary at (just before) the sampling instant. Moreover, the explicit usage of the inverse can be avoided altogether. Rewriting equation (5.8) leads to

$$\hat{\zeta}(t_i) = \mathcal{H}(\hat{x}(t_i), U(t_i; \hat{x}(t_{i-1}))). \quad (5.9)$$

In principle this equation, together with the known values of $\hat{\zeta}(t_i^-)$ and $U(t_i; \hat{x}(t_{i-1}))$, can be added to the dynamic optimization problem (5.3) that is solved in the NMPC controller at time t_i . This does not change the solution of (5.3), since the value of \hat{x} , due to the uniform complete observability assumption, is uniquely defined by (5.9). Thus, instead of using the inverse explicitly, we let the optimization software solve for \hat{x} .

Another possibility to avoid explicit information on \mathcal{H}^{-1} is to rewrite the observer equations in terms of the original coordinates (Ciccarella, Dalla Mora and Germani, 1993, Maggiore and Passino, 2001). The high-gain observer (5.7) for $\phi = \hat{\phi}$ (no mismatch between the estimator and the real system) in x coordinates is given by:

$$\dot{\hat{x}} = f(\hat{x}, u) + \left[\frac{\partial \mathcal{H}}{\partial x}(\hat{x}, U) \right]^{-1} H_\epsilon(y - h(\hat{x}, u)). \quad (5.10)$$

In Maggiore and Passino (2001) an additional projection of the observer state into the observable part of the state space is required since systems that are not uniformly completely observable and control laws that are not globally bounded are considered. This projection is not necessary here, since the input resulting from the NMPC controller is bounded, and since we limit ourselves to uniformly completely observable systems.

If $[\partial \mathcal{H} / \partial x(\hat{x}, U)]^{-1}$ is not known, one can left-multiply (5.10) by $\partial \mathcal{H} / \partial x$. The resulting system can be efficiently solved using index one DAE integrators. This is advantageous, since $\partial \mathcal{H} / \partial x$ is rather easy to acquire from \mathcal{H} via differentiation. The disadvantage of this approach and the basic high-gain observer is that U must be known all times.

Obtaining the necessary u derivatives

To obtain a state estimate via the high-gain observer the applied input and the derivatives appearing in \tilde{U} must be known. Furthermore, if derivatives of u appear they must be bounded. Since the input is determined via an open-loop optimal control problem at the sampling instants, the NMPC setup can be modified to provide the necessary information and guarantee the boundedness. Different possibilities to achieve this exist: One can a)

augment the system model used in the NMPC state feedback by integrators at the input side, or b) parameterize the input $u(t)$ in the optimization problem such that the input is sufficiently smooth with bounded derivatives. In the approach a), adding the integrators leads to a set of new inputs and the NMPC controller must be designed to stabilize the expanded model. Furthermore, to guarantee boundedness of the inputs and its derivatives, constraints on the new inputs must be added. While this does not change the local stabilizability property (Isidori, 1995), nothing can be said about the global properties in general. In the case of no input constraints the integrator backstepping lemma (Krstić et al., 1995) provides that the global stabilizability is not influenced. However, this result cannot be used, since constraints on the inputs are present.

In the following we assume that the NMPC controller is designed such that it guarantees that the input is sufficiently often differentiable and that it provides the full \tilde{U} vector.

Assumption 5.6 *The input obtained by the NMPC controller is continuous over the first sampling interval, sufficiently often differentiable, bounded and known, i.e. the NMPC open-loop optimal control problem provides the continuous “input” vector $\tilde{U}(t_i + \tau; x(t_i)) \in \mathcal{U}_{\mathcal{H}}$, $\tau \in [0, \delta)$ with $\mathcal{U}_{\mathcal{H}} = \mathcal{U} \times \mathcal{U}_{\mathcal{H}d} \subset \mathbb{R}^{m+\tilde{m}_U}$, where $\mathcal{U}_{\mathcal{H}d} \subset \mathbb{R}^{\tilde{m}_U}$ is a compact set and \tilde{m}_U is the number of derivatives that appear in \tilde{U} .*

In the special case that no input derivatives appear in \mathcal{H} no change in the NMPC controller is necessary. This is for example the case for systems having full vector relative degree.

5.3.3 Overall output feedback setup

The overall output feedback control is given by the state feedback NMPC controller and a high-gain observer. The open-loop input is only calculated at the sampling instants using the state estimates of the observer. The observer state $\hat{\zeta}$ is initialized with $\hat{\zeta}_0$ which, transformed to the original coordinates, satisfies $\hat{x}_0 \in \mathcal{Q}$. The set $\mathcal{Q} \subset \mathbb{R}^n$ with $0 \in \mathcal{Q}$ is a compact subset of possible observer initial values. The closed-loop system with the observer specified

in observability normal form can be described by

$$\begin{aligned}
 \text{system:} \quad & \dot{x}(t) = f(x(t), u(t; \hat{x}(t_i))), \quad x(0) = x_0 \\
 & y(t) = h(x(t), u(t; \hat{x}(t_i))) \\
 \text{observer:} \quad & \dot{\hat{\zeta}}(t) = A\hat{\zeta}(t) + B\hat{\phi}(\hat{\zeta}(t), \tilde{U}(t; \hat{x}(t_{i-1}))) + H_\epsilon(y(t) - C\hat{\zeta}(t)), \\
 \text{with} \quad & \hat{\zeta}(t_i) = \begin{cases} \mathcal{H}(\hat{x}(t_i), U(t_i; \hat{x}(t_i))) & \text{if } \hat{x}(t_i) \in \mathcal{Q} \\ \hat{\zeta}_0 & \text{if } \hat{x}(t_i) \notin \mathcal{Q} \end{cases} \quad (5.11) \\
 \text{NMPC:} \quad & \text{defined by (5.3), provides } u(t; \hat{x}(t_i)), U(t; \hat{x}(t_i)), \tilde{U}(t; \hat{x}(t_i)) \\
 & \text{using } \hat{x}(t_i) = \mathcal{H}^{-1}(\hat{\zeta}(t_i^-), U(t_i; \hat{x}(t_{i-1}))) \text{ as state estimate.}
 \end{aligned}$$

Remark 5.3 *While the observer itself operates continuously, it might be necessary to reinitialize the observer state ζ at the sampling instants, as defined in equation (5.11). This is a consequence of the fact that \mathcal{H} in general depends on u and its derivatives. Thus, since u and its derivatives might be discontinuous at the sampling instants (compare Assumption 5.6), the observer state might jump at the sampling instants. While at a first glance the reinitialization seems to be unnecessary, it avoids that the observer “initial” state $\hat{x}(t_i) = \mathcal{H}^{-1}(\hat{\zeta}(t_i^-), U(t_i; \hat{x}(t_{i-1})))$ at the sampling instant, due to the possible discontinuity in u , is outside the compact set \mathcal{Q} . Note that either way the discontinuities of u at the sampling instants in general make ζ discontinuous, which means the analysis has to take the discontinuities in the observer error into consideration. This is also the reason that one must differentiate between t_i^- , which denotes the left limit of the corresponding trajectory for t_i , and the value at t_i , i.e. the ζ values for t_i^- and t_i might differ.*

Figure 5.1 shows the time sequence of the overall output feedback scheme. The arrows in Figure 5.1 pointing from the trajectories of y to $\hat{\zeta}$ illustrate that the high-gain observer is continuous time and thus continuously updated with the output measurements in between sampling instants. In contrast, the NMPC open-loop optimal control problem is solved only at the sampling instants t_i and the input is open-loop implemented in between.

Note that the observer estimate is not bounded to the feasibility region \mathcal{R} of the NMPC controller. Since the open-loop optimal control problem will not have a solution outside \mathcal{R} , we have to define a valid input in this case.

Assumption 5.7 *The open-loop input must also be defined outside the feasible region \mathcal{R} of the NMPC controller. For simplicity we assume that the input is fixed to an arbitrary value $u_f \in \mathcal{U}$ for all $x \notin \mathcal{R}$: $u(\tau; x) = u_f$, $\tau \in [t, t+\delta)$.*

Thus $u(\tau; \hat{x})$ is defined and bounded for all $\hat{x} \in \mathbb{R}^n$.

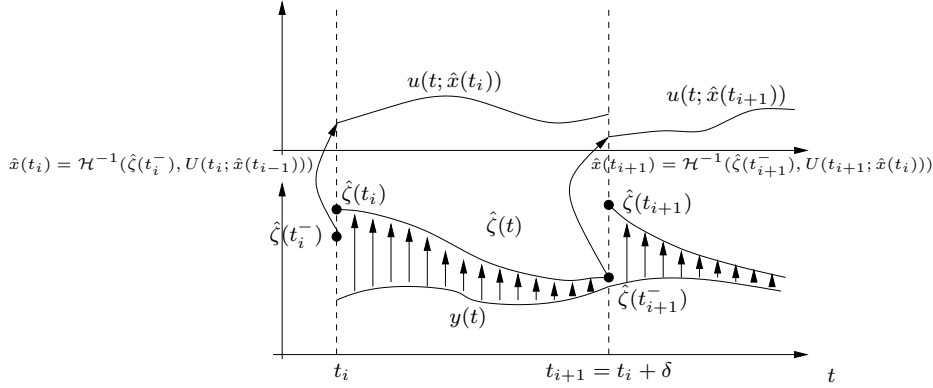

Figure 5.1: Time sequence of the overall output feedback control scheme.

5.4 Practical stability

In this section semi-global practical stability of the closed-loop system state is established. In the first step we show that for any compact subset of \mathcal{R} for the initial states x and any compact set of initial conditions of the observer initial states, the closed-loop states stay bounded for small enough ϵ and δ . Furthermore, at the end of each sampling interval the observer error has converged to an arbitrarily small set. In a next step it is established that for a sufficiently small ϵ the closed loop system state trajectories converge in finite time to a (arbitrarily) small region containing the origin. In principle we use similar arguments as in Atassi and Khalil (1999). However, since we consider a sampled-data feedback employing open-loop input trajectories between the sampling instants, we cannot make use of standard Lyapunov and converse Lyapunov arguments. Instead we utilize the decrease-properties of the NMPC state feedback value function along solution trajectories. Moreover, we only establish that the observer error stays bounded and converges to a small region at the end of each sampling interval. Due to the necessary reinitialization, the observer state might, however, leave this small region. For the practical stabilization of the system this is not a problem, since the state estimate is only needed at the end of each sampling interval to calculate a new feasible optimal input.

In the following we suppress most of the time the (known) “input” $U(t; x(t_i))$ and $\tilde{U}(t; x(t_i))$ in the notation, e.g. $\mathcal{H}(x)$ should be read as $\mathcal{H}(x, U)$. Furthermore, it is convenient to work in scaled observer error coordinates based

on the observability normal form. The scaled observer error η is defined as

$$\eta = [\eta_{11}, \dots, \eta_{r_1}, \dots, \eta_{p_1}, \dots, \eta_{pr_p}], \quad \text{with} \quad \eta_{ij} = \frac{\zeta_{ij} - \hat{\zeta}_{ij}}{\epsilon^{r_i-j}}.$$

Hence we have that $\hat{\zeta} = \zeta - D_\epsilon \eta$ with $D_\epsilon = \text{blockdiag}[D_{\epsilon,1}, D_{\epsilon,2}, \dots, D_{\epsilon,p}]$, $D_{\epsilon,i} = \text{diag}[\epsilon^{r_i-1}, \dots, 1]$. The closed-loop system in between sampling instants is then given by

$$\begin{aligned} \dot{x}(t) &= f(x(t), u(t; \hat{x}(t_i))) \\ \epsilon \dot{\eta}(t) &= A_0 \eta(t) + \epsilon B g(t, x(t), x(t_i), \eta(t), \eta(t_i^-)) \end{aligned}$$

where the matrix $A_0 = \epsilon D_\epsilon^{-1}(A - HC)D_\epsilon$ is independent of ϵ and where the function g is defined as the difference between $\hat{\phi}$ and ϕ ,

$$g(t, x(t), x(t_i), \eta(t), \eta(t_i^-)) = \phi(\zeta(t), \tilde{U}(t; \hat{x}(t_i))) - \hat{\phi}(\hat{\zeta}(t), \tilde{U}(t; \hat{x}(t_i))).$$

Here the estimated system state $\hat{x}(t_i)$ and ζ , $\hat{\zeta}$ are given in terms of η , x and u by

$$\begin{aligned} \hat{x}(t_i) &= \mathcal{H}^{-1}(\mathcal{H}(x(t_i)) - D_\epsilon \eta(t_i^-)) \\ \zeta(t) &= \mathcal{H}(x(t)) \\ \hat{\zeta}(t) &= \mathcal{H}(x(t)) - D_\epsilon \eta(t). \end{aligned}$$

We often compare, over one sampling interval, the state trajectories of the output feedback closed loop with the trajectories resulting from the application of the state feedback NMPC controller starting at the same initial condition. The state feedback trajectories starting at $x(t_i)$ are denoted, with slight abuse of notation, by $\bar{x}(t; x(t_i))$

$$\dot{\bar{x}}(t; x(t_i)) = f(\bar{x}(t; x(t_i)), u(t; x(t_i))), \quad \bar{x}(t_i; x(t_i)) = x(t_i), \quad t \in [t_i, t_i + \delta]. \quad (5.12)$$

For simplicity of presentation we assume, without loss of generality, that $0 < \epsilon \leq 1$. This implies that $\|D_\epsilon\| \leq 1$.

5.4.1 Preliminaries

Before we move to the practical stability and boundedness results we establish some properties of the observer and controller. We show that for an observer initial condition \hat{x} starting in a compact set \mathcal{Q} , the scaled observer error can be brought in any desired small time to any small set around the origin and remain in this set, as long as the system state stays in a compact

region (and the input U is continuous). Moreover, we will derive a bound on the difference between the state feedback and output feedback trajectories for a given observer error.

In the following the set $\mathcal{Q} \subset \mathbb{R}^n$ is a fixed compact set for the observer initial state \hat{x}_0 , whereas $\Gamma_\epsilon := \{\eta \in \mathbb{R}^n | W(\eta) \leq \rho\epsilon^2\}$ defines a set for the scaled observer error η that directly depends on ϵ . The constant ρ is specified in the proof of the following lemma and $W(\eta)$ is defined by $W(\eta) = \eta^\top P_0 \eta$, where P_0 is the solution of the Lyapunov equation $P_0 A_0 + A_0^\top P_0 = -I$.

The following Lemma is similar to a result obtained in Atassi and Khalil (1999).

Lemma 5.1 (Convergence of the scaled observer error) *Given any time $0 < T$ such that \hat{U} is continuous over $[0, T]$, two compact sets $\Omega_c \subset \mathcal{R}$ and $\mathcal{Q} \subset \mathbb{R}^n$, and let Assumptions 5.2 and 5.5 hold. Furthermore suppose that the system state satisfies $x(\tau) \in \Omega_c$, $0 \leq \tau \leq T$. Then there exists an ϵ_1^* , a constant ρ , and a finite time $T_{\mathcal{Q}}(\epsilon) \leq T$ such that for any $\hat{x}_0 \in \mathcal{Q}$ and for all $0 < \epsilon \leq \epsilon_1^*$ the scaled observer states $\eta(\tau)$ are bounded for $\tau \in [0, T]$ and that $\eta(\tau) \in \Gamma_\epsilon$, $\tau \in [T_{\mathcal{Q}}(\epsilon), T]$.*

Proof. First note that

$$\begin{aligned} \dot{W} &= \frac{\partial W}{\partial \eta} \dot{\eta} \\ &= \frac{1}{\epsilon} \frac{\partial W}{\partial \eta} (A_0 \eta(t) + \epsilon B g(t, x(t), x(t_i), \eta(t), \eta(t_i^-))). \end{aligned} \quad (5.13)$$

“Invariance” of Γ_ϵ : We first show that there exists a constant ρ such that for all $x \in \Omega_c$ and $\eta \in \{\eta \in \mathbb{R}^n | W(\eta) \geq \rho\epsilon^2\}$ the right hand side of (5.13) is smaller than zero, thus establishing that as long as $\eta(t)$ is continuous, $\eta(t)$ will not leave Γ_ϵ once inside. To establish this we utilize that for $x(t) \in \Omega_c$ there exists a constant k_g such that:

$$\|B g(t, x(t), x(t_i), \eta(t), \eta(t_i^-))\| = \|g(t, x(t), x(t_i), \eta(t), \eta(t_i^-))\| \leq k_g, \quad \forall x \in \Omega_c. \quad (5.14)$$

The existence of such a constant follows from the local Lipschitz property of ϕ (as a result of the smoothness of f and \mathcal{H} , compactness of $\mathcal{U}_{\mathcal{H}}$ and the compactness of Ω_c) and the global boundedness of $\hat{\phi}$. Hence

$$\dot{W} \leq -\frac{1}{\epsilon} \|\eta\|^2 + 2\|\eta\| \|P_0\| k_g.$$

We rewrite this as

$$\dot{W} \leq -\frac{1}{2\epsilon} \|\eta\|^2 - \frac{1}{2\epsilon} \|\eta\|^2 + 2\|\eta\| \|P_0\| k_g.$$

If we can find a ρ such that the last two terms are bounded by zero as long as $W(\eta) \geq \rho\epsilon^2$, then we know that if η reaches Γ_ϵ it will stay there. To achieve this consider the boundary of Γ_ϵ defined by $\eta^\top P_0 \eta = \rho\epsilon^2$ where $\rho > 0$. Using $\frac{\rho\epsilon^2}{\|P_0\|} \leq \|\eta\|^2 \leq \frac{\rho\epsilon^2}{\lambda_{\min}(P_0)}$ we thus require:

$$\left(\frac{\rho}{2\|P_0\|} - 2\frac{\sqrt{\rho}}{\sqrt{\lambda_{\min}(P_0)}}\|P_0\|k_g \right) \epsilon \leq 0, \quad \text{for } W(\eta) = \rho\epsilon^2.$$

Choosing

$$\rho := 16\frac{\|P_0\|^4}{\lambda_{\min}(P_0)}k_g^2 \quad (5.15)$$

satisfies this condition and leads to

$$\dot{W} \leq -\frac{1}{2\epsilon}\|\eta\|^2, \quad \text{for } W(\eta) \geq \rho\epsilon^2. \quad (5.16)$$

Thus, once η enters Γ_ϵ it will not leave it again, as long as η is continuous which is guaranteed on $[0, T]$ since \tilde{U} is continuous on this interval. Note that (5.16) also guarantees boundedness of $\eta(t)$ on $[0, T]$.

Finite convergence time of the scaled observer error to Γ_ϵ : Consider now that $x(\tau) \in \Omega_c$, $\tau \in [0, T]$ and $\hat{x}_0 \in \mathcal{Q}$. Since $\mathcal{U}_{\mathcal{H}}$, Ω_c and \mathcal{Q} are compact and \mathcal{H} is smooth, we know that there exists a constant $k_{\mathcal{Q}}$ such that $\|\zeta(0) - \hat{\zeta}(0)\| \leq k_{\mathcal{Q}}$. Thus it follows that $\|\eta(0)\| \leq k_{\mathcal{Q}}/\epsilon^{r_{\max}-1}$, where $r_{\max} = \max\{r_1, \dots, r_p\}$. By (5.16) $W(\eta)$ is strictly decreasing as long as $W(\eta) \geq \rho\epsilon^2$. Let \tilde{T} be the time when η enters Γ_ϵ . Integrating from $t = 0$ to $t = \tilde{T}$ results in

$$\ln \frac{W(\eta_0)}{W(\eta(\tilde{T}))} \geq \frac{1}{2\epsilon\|P_0\|}\tilde{T}.$$

Solving for \tilde{T} and setting $W(\eta(\tilde{T})) = \rho\epsilon^2$ we obtain in the limit

$$\tilde{T} \leq 2\epsilon\|P_0\| \ln \left(\frac{W(\eta_0)}{\rho\epsilon^2} \right).$$

We know that $\|\eta_0\| \leq k_{\mathcal{Q}}/\epsilon^{r_{\max}-1}$. Considering the worst case leads to

$$\tilde{T} \leq T_{\mathcal{Q}}(\epsilon) := 2\epsilon\|P_0\| \ln \left(\frac{\|P_0\|k_{\mathcal{Q}}^2}{\rho\epsilon^{2r_{\max}}} \right),$$

where the time $T_{\mathcal{Q}}(\epsilon)$ is an upper bound for \tilde{T} . Choosing ϵ_1^* sufficiently small, we know that for all $\epsilon \leq \epsilon_1^*$, $T_{\mathcal{Q}}(\epsilon) \leq T$. The existence of such an ϵ_1^* is guaranteed since the right hand side of the inequality tends to zero as ϵ tends to zero. Thus we can reach the set $\Gamma_\epsilon = \{\eta \in \mathbb{R}^n | W(\eta) \leq \rho\epsilon^2\}$ in less than any given time T . ■

Remark 5.4 *Note that the size of the set Γ_ϵ and the time $T_Q(\epsilon)$ depend on ϵ . Decreasing ϵ leads to a shrinking Γ_ϵ while also shrinking the time $T_Q(\epsilon)$ needed to reach Γ_ϵ . Furthermore, note that an upper estimate of the error in the original coordinates for $\eta \in \Gamma_\epsilon$ is given by:*

$$\begin{aligned} \|x - \hat{x}\| &= \|\mathcal{H}^{-1}(\zeta, U) - \mathcal{H}^{-1}(\hat{\zeta}, U)\| \\ &\leq L_{\mathcal{UH}} \|\zeta - \hat{\zeta}\| \\ &\leq L_{\mathcal{UH}} \|D_\epsilon\| \|\eta\| \\ &\leq k_\Gamma \epsilon \quad \text{for } \eta \in \Gamma_\epsilon, \end{aligned}$$

where k_Γ is a constant that depends on the Lipschitz constant $L_{\mathcal{UH}}$ of \mathcal{H}^{-1} (and hence on \mathcal{UH} , Ω_c (a compact set for the states) and \mathcal{Q}). Thus decreasing ϵ also decreases the observer error in the original coordinates after the time $T_Q(\epsilon)$. This, together with robustness properties of the state feedback NMPC controller are the key elements in the output feedback stability results.

The next Lemma establishes a bound on the difference between the trajectories resulting from the NMPC controller with exact state information and the NMPC controller using an incorrect state estimate. From now on, Ω_c will denote level sets of $V(x)$ defined by $\Omega_c := \{x \in \mathcal{R} | V(x) \leq c\}$, and the set $\Omega_c(\mathcal{S})$ denotes a level set Ω_c that contains the (assumed compact) set $\mathcal{S} \subset \mathcal{R}$, i.e. $c > \max_{x \in \mathcal{S}} V(x)$.

Lemma 5.2 (Bound on distance between state and output feedback trajectories) *Let Assumptions 5.1-5.4 hold, and let three compact sets $\mathcal{Q} \subset \mathbb{R}^n$, $\mathcal{S} \subset \mathcal{R}$ and $\Omega_c(\mathcal{S}) \subset \mathcal{R}$ with $\mathcal{S} \subset \Omega_c(\mathcal{S})$ be given. Consider the system (2.1) driven by the NMPC open-loop control law (5.4) using the correct state x_0 (state feedback) and the state estimate $\hat{x}_0 \in \mathcal{Q}$ (output feedback)*

$$\dot{x}(\tau) = f(x(\tau), u(\tau; \hat{x}_0)), \quad \dot{\bar{x}}(\tau) = f(\bar{x}(\tau), u(\tau; x_0)), \quad x(0) = \bar{x}(0) = x_0. \quad (5.17)$$

Then there exists a time $T_S \leq T_p$ such that for all $\hat{x}_0 \in \mathcal{Q}$, $x_0 \in \mathcal{S}$, we have $x(\tau), \bar{x}(\tau) \in \Omega_c(\mathcal{S})$ and

$$\|x(\tau) - \bar{x}(\tau)\| \leq \frac{L_{fu}L_u}{L_{fx}} \|x_0 - \hat{x}_0\| (e^{L_{fx}\tau} - 1), \quad \tau \in [0, T_S].$$

Here L_{fx} and L_{fu} are the Lipschitz constants of f in $\Omega_c(\mathcal{S}) \times \mathcal{U}$, and L_u is the ‘‘Lipschitz constant’’ of u as defined in Assumption 5.3.2.

Proof. Since $\mathcal{S} \subset \Omega_c(\mathcal{S})$, u piecewise continuous and bounded there always exists a time $T_{\mathcal{S}} \leq T_p$ such that $x(\tau), \bar{x}(\tau) \in \Omega_c(\mathcal{S})$ for all $\tau \in [0, T_{\mathcal{S}}]$ and that the solutions are continuous. This follows from the fact that for $x(\cdot)$ in $\Omega_c(\mathcal{S})$,

$$\|x(\tau) - x_0\| \leq \int_0^\tau \|f(x(s), u(s))\| ds \leq k_\Omega \tau,$$

(and the same for $\bar{x}(\tau)$) where k_Ω is a constant depending on the Lipschitz constants of f and the bounds on u . The solutions to (5.17) for any $\tau \in [0, T_{\mathcal{S}}]$ can be written as:

$$x(\tau) = x_0 + \int_0^\tau f(x(s), u(s; \hat{x}_0)) ds, \quad \bar{x}(\tau) = x_0 + \int_0^\tau f(\bar{x}(s), u(s; x_0)) ds.$$

Thus

$$\|x(\tau) - \bar{x}(\tau)\| \leq \int_0^\tau \|f(x(s), u(s; \hat{x}_0)) - f(\bar{x}(s), u(s; x_0))\| ds.$$

Since f is locally Lipschitz in \mathcal{R} (and hence in $\Omega_c(\mathcal{S})$) and $u(\tau; x)$ is uniformly locally Lipschitz in x we obtain

$$\begin{aligned} \|x(\tau) - \bar{x}(\tau)\| &\leq \int_0^\tau (L_{fx} \|x(s) - \bar{x}(s)\| + L_{fu} L_u \|x_0 - \hat{x}_0\|) ds \\ &\leq L_{fu} L_u \|x_0 - \hat{x}_0\| \tau + \int_0^\tau L_{fx} \|x(s) - \bar{x}(s)\| ds, \end{aligned}$$

where L_{fu}, L_{fx} are the Lipschitz constants of f in $\Omega_c(\mathcal{S}) \times \mathcal{U}$, and L_u is the ‘‘Lipschitz constant’’ of u as defined in Assumption 5.3.2. Using the Gronwall-Bellman inequality we obtain for all $\tau \in [0, T_{\mathcal{S}}]$

$$\|x(\tau) - \bar{x}(\tau)\| \leq \frac{L_{fu} L_u}{L_{fx}} \|x_0 - \hat{x}_0\| (e^{L_{fx} \tau} - 1),$$

which proves the Lemma. ■

In the following we make use of the following fact that gives a lower bound on the first ‘‘piece’’ of the NMPC state feedback value function:

Fact 1 *For any $c > 0, c > \alpha > 0, T_p > \delta > 0$ the following lower bound $V_{\min}(c, \alpha, \delta)$ exists and is non-trivial for all $x_0 \in \Omega_c/\Omega_\alpha$:*

$$0 < V_{\min}(c, \alpha, \delta) := \min_{x_0 \in \Omega_c/\Omega_\alpha} \int_0^\delta F(\bar{x}(s; x_0), u(s; x_0)) ds < \infty.$$

5.4.2 Boundedness of the states

In this section we establish that the closed-loop states remain bounded for sufficiently small ϵ and δ .

Theorem 5.1 (Boundedness of the states) *Assume that the Assumptions 5.1-5.7 are fulfilled. Let the compact sets \mathcal{Q} , \mathcal{S} and $\Omega_c(\mathcal{S})$ with $\mathcal{Q} \subset \mathbb{R}^n$ and $\mathcal{S} \subset \Omega_c(\mathcal{S}) \subset \mathcal{R}$ be given. Then there exists $\delta_2^* > 0$ such that for $0 < \delta \leq \delta_2^*$, there exists $\epsilon_2^* > 0$ (dependent on δ), such that for all $0 < \epsilon \leq \epsilon_2^*$ and all initial conditions $(x_0, \hat{x}_0) \in \mathcal{S} \times \mathcal{Q}$, the observer error $\eta(\tau)$ stays bounded and converges at least at the end of every sampling interval to the set Γ_ϵ . Furthermore, $x(\tau) \in \Omega_c(\mathcal{S}) \forall \tau \geq 0$.*

Proof. The proof is divided into two parts. In the first part it is shown that there exists sufficiently small δ and ϵ such that the observer error converges to the set Γ_ϵ at least at the end of the first sampling interval, starting with $\hat{x}(t_0) \in \mathcal{Q}$ and $x(0) \in \mathcal{S}$, and that $x(t)$ in this interval does not leave $\Omega_c(\mathcal{S})$. In a second step we establish that $x(t)$ will remain in $\Omega_c(\mathcal{S})$ while $\eta(t)$ stays bounded and converges (at least) at the end of each sampling interval (t_i^-) to Γ_ϵ . Note that η might jump at the sampling instants t_i due to the discontinuities in U and the possible reinitialization (5.11). This is the reason why we can not establish that η enters the set Γ_ϵ and stays there. However, this is not a problem for controlling the state, since the state estimate is only needed at the end of each sampling interval.

We denote the smallest set² of V that covers \mathcal{S} by $\Omega_{c_1}(\mathcal{S})$. The constant $c_1 < c$ is given by $c_1 = \max_{x \in \mathcal{S}} V(x)$.

First sampling interval, existence of ϵ , δ such that $\eta(t_1^-) \in \Gamma_\epsilon$ and $x(\tau) \in \Omega_c(\mathcal{S})$, $\tau \in [0, t_1]$:

Since \mathcal{S} is strictly contained in $\Omega_c(\mathcal{S})$, there exist a time T_c such that trajectories starting in \mathcal{S} do not leave $\Omega_c(\mathcal{S})$ on the interval $[t, t + T_c]$. The existence is guaranteed, since as long as $x(t) \in \Omega_c(\mathcal{S})$,

$$\|x(t) - x_0\| \leq \int_0^t \|f(x(s), u(s))\| ds \leq k_\Omega t.$$

We take T_c as the smallest possible (worst case) time to reach the boundary of $\Omega_c(\mathcal{S})$ from a point $x_0 \in \Omega_{c_1} \supset \mathcal{S}$, allowing $u(s)$ to take any value in \mathcal{U} . Due to the compactness of \mathcal{Q} we know from Lemma 5.1 that $\eta(t) \in \Gamma_\epsilon$ for $t_1 \geq t \geq T_Q(\epsilon)$. Since $T_Q(\epsilon) \rightarrow 0$ as $\epsilon \rightarrow 0$, there exists an ϵ_1 such that for all $0 < \epsilon \leq \epsilon_1$, $T_Q(\epsilon) \leq \frac{T_c}{2}$. Let δ_2^* be such that for all $0 < \delta \leq \delta_2^*$, the first

²Figure 5.3 illustrates some of the sets.

sampling instant $t_1 = \delta$ satisfies $T_{\mathcal{Q}}(\epsilon) < t_1 < \frac{T_c}{2}$. Choose one such δ for the rest of the proof. Then $(x(t_1), \eta(t_1^-)) \in \Omega_c(\mathcal{S}) \times \Gamma_\epsilon$, and the same hold for the next sampling instant (since we used $T_c/2$ for choosing δ_2^*).

We will in the following refer to the smallest level set covering all points that can be reached from points in $\Omega_{c_1}(\mathcal{S})$ in the time $T_c/2$ applying any admissible control by $\Omega_{c_{T_c/2}}(\mathcal{S})$. Note that by the arguments given above, $x(t_1) \in \Omega_{c_{T_c/2}}(\mathcal{S})$, with $c_{T_c/2} < c$.

Invariance of Ω_c for x at sampling instants, convergence of η to Γ_ϵ for each t_i^- :

Consider a sampling instant t_i (e.g. t_1) for which we know that $x(t_i) \in \Omega_{c_{T_c/2}}(\mathcal{S})$ and that $x(t_i + \tau) \in \Omega_c(\mathcal{S})$ for $0 \leq \tau \leq \delta$ and $\eta(t_i^-) \in \Gamma_\epsilon$. Note that we do not have to consider the case when $x(t_i + \tau) \in \Omega_{c_1}(\mathcal{S})$ for some $0 \leq \tau \leq \delta$, since the reasoning in the first part of the proof ensures in this case that the state will not leave the set $\Omega_{c_{T_c/2}}(\mathcal{S})$ in one sampling interval (considering the worst case input). Hence we assume in the following that $x(t_i + \tau) \in \Omega_c(\mathcal{S})/\Omega_{c_1}(\mathcal{S})$.

Now consider the difference in the value function between the initial state $x(t_i)$ and the developing state $x(t_i + \tau)$,

$$\begin{aligned} & V(x(t_i + \tau)) - V(x(t_i)) \\ & \leq V(\bar{x}(t_i + \tau; x(t_i))) - V(x(t_i)) + |V(x(t_i + \tau)) - V(\bar{x}(t_i + \tau; x(t_i)))| \\ & \leq - \int_{t_i}^{t_i + \tau} F(\bar{x}(s; x(t_i)), u(s; x(t_i))) ds + |V(x(t_i + \tau)) - V(\bar{x}(t_i + \tau; x(t_i)))|. \end{aligned} \quad (5.18)$$

Since V is Lipschitz in compact subsets of $\mathcal{R} \supset \Omega_c(\mathcal{S})$ we obtain:

$$\begin{aligned} & V(x(t_i + \tau)) - V(x(t_i)) \\ & \leq - \int_{t_i}^{t_i + \tau} F(\bar{x}(s; x(t_i)), u(s; x(t_i))) ds + L_V \|x(t_i + \tau) - \bar{x}(t_i + \tau; x(t_i))\|, \end{aligned}$$

where L_V is the Lipschitz constant of V in $\Omega_c(\mathcal{S})$. The integral contribution is only a function of the predicted open-loop trajectories of the NMPC state feedback controller. Using Fact 1 and Lemma 5.2 this leads to:

$$\begin{aligned} & V(x(t_i + \delta)) - V(x(t_i)) \\ & \leq -V_{\min}(c, \alpha, \delta) + L_V \frac{L_{fu} L_u}{L_{fx}} \|x(t_i) - \hat{x}(t_i)\| \left(e^{L_{fx} \delta} - 1 \right) \end{aligned} \quad (5.19)$$

for any fixed $\alpha < c_1$ and $x(t_i) \notin \Omega_\alpha$. From Remark 5.4 we know that there exists an $0 < \epsilon_2$ such that for all $0 < \epsilon < \epsilon_2$,

$$V(x(t_i + \delta)) - V(x(t_i)) \leq -\frac{1}{2}V_{\min}(c, \alpha, \delta) =: -\kappa_1,$$

where $\kappa_1 > 0$ is a constant given by the right hand side of (5.19). Hence the state at the next sampling instant is at least within $\Omega_{c_{T_c/2}}(\mathcal{S})$ again, and thus also in $\Omega_c(\mathcal{S})$. Since $x(t_{i+1}) \in \Omega_{c_{T_c/2}}(\mathcal{S})$, it will by the reasoning in the first part not leave $\Omega_c(\mathcal{S})$ during the next sampling interval, and hence the arguments in the second part holds for this interval as well. By an induction argument, the state will not leave $\Omega_c(\mathcal{S})$, and setting $\epsilon_2^* := \min\{\epsilon_1, \epsilon_2\}$ concludes the proof. ■

Figure 5.2 is an attempt to sketch the main ideas of the proof.

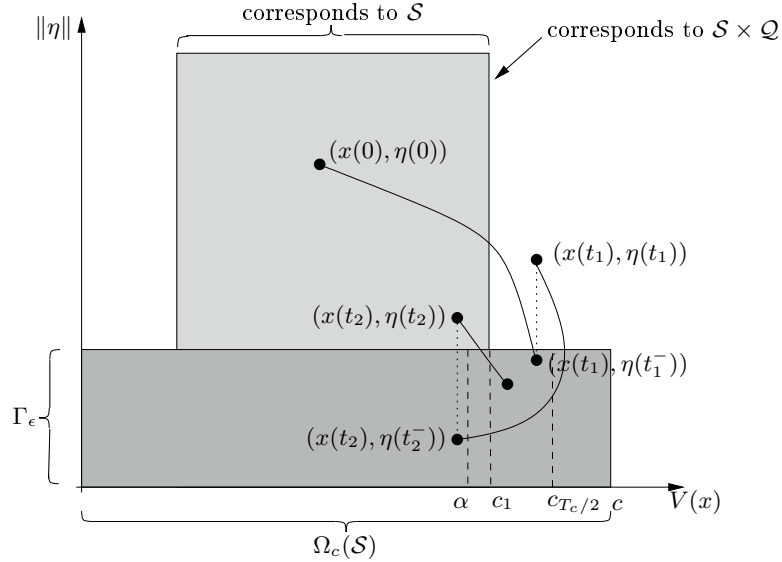

Figure 5.2: Sketch of the main ideas behind the proof of Theorem 5.1.

5.4.3 Semi-global practical stability

In this section we show that the output feedback scheme can achieve practical stability of the system states. It is established that for any small ball around the origin, there exists an observer gain and a sampling period such that the state trajectory converges to the ball in finite time and stay inside the ball.

Theorem 5.2 (Practical stability) *Let the compact sets \mathcal{Q} , \mathcal{S} and $\Omega_c(\mathcal{S})$ with $\mathcal{Q} \subset \mathbb{R}^n$ and $\mathcal{S} \subset \Omega_c(\mathcal{S}) \subset \mathcal{R}$ be given. Furthermore, let the Assump-*

tions 5.1-5.7 hold. Then, for any set Ω_α with $c > \alpha > 0$, there exists $\delta_3^* > 0$ such that for a $0 < \delta \leq \delta_3^*$, there exists $\epsilon_3^* > 0$ (dependent on δ), such that for all $0 < \epsilon \leq \epsilon_3^*$ and all $(x_0, \hat{x}_0) \in \mathcal{S} \times \mathcal{Q}$, the observer error $\eta(\tau)$ stays bounded and the state $x(\tau)$ converges in finite time to the set Ω_α and remains there.

Proof. First we show that there exists an ϵ sufficiently small, such that for any $0 < \beta < \alpha$, $\Omega_\beta \subset \Omega_\alpha$, trajectories originating in Ω_β at a sampling instant do not leave Ω_α ³. Then we establish that the states starting at $\hat{x}_0 \in \mathcal{Q}$ and $x_0 \in \mathcal{S}$ enter Ω_β in finite time. In the first part we consider any fixed $\delta \leq \delta_2^*$. “Invariance” of Ω_α for $x(t_i)$ originating in Ω_β :

For $x(t_i) \in \Omega_\beta$ and $\tau \leq \delta$, by Lemma 5.2, the state feedback and output feedback trajectories satisfy the bound

$$\begin{aligned} |V(x(t_i + \tau)) - V(\bar{x}(t_i + \tau; x(t_i)))| \\ \leq L_V \|x(t_i + \tau) - \bar{x}(t_i + \tau; x(t_i))\| \\ \leq L_V \frac{L_{fu}L_u}{L_{fx}} \|x(t_i) - \hat{x}(t_i)\| (e^{L_{fx}\tau} - 1). \end{aligned} \quad (5.20)$$

Furthermore, the state feedback trajectory satisfies $\bar{x}(t_i + \tau; x(t_i)) \in \Omega_\beta$ for $\tau \in [0, \delta]$ by Assumption 5.3.4. So one can choose an ϵ_1 such that for $0 < \epsilon \leq \epsilon_1$, $V(x(t_i + \tau)) \leq \alpha$ for $\tau \in [0, \delta]$, for all $x(t_i) \in \Omega_\beta$. Thus the trajectory $x(t_i + \tau)$ does not leave the set Ω_α for $\tau \in [0, \delta]$.

Now we define an additional level set Ω_γ inside of Ω_β given by $0 < \gamma < \beta$. We proceed considering two cases, $x(t_i) \in \Omega_\gamma$ and $x(t_i) \in \Omega_\beta/\Omega_\gamma$.
 $x(t_i) \in \Omega_\beta/\Omega_\gamma$: Similar to equation (5.19) in the proof of Theorem 5.1, we can establish that for all $x(t_i) \notin \Omega_\gamma$,

$$V(x(t_i + \delta)) - V(x(t_i)) \leq -V_{\min}(c, \gamma, \delta) + L_V \frac{L_{fu}L_u}{L_{fx}} \|x(t_i) - \hat{x}(t_i)\| (e^{L_{fx}\delta} - 1).$$

By Remark 5.4, we can choose ϵ_2 such that for $0 < \epsilon < \epsilon_2$,

$$V(x(t_i + \delta)) - V(x(t_i)) \leq -\frac{1}{2}V_{\min}(c, \gamma, \delta) =: -\kappa_2. \quad (5.21)$$

Hence $x(t_i + \delta) \in \Omega_\beta$ for $x(t_i) \in \Omega_\beta/\Omega_\gamma$. Additionally, we know from the first part of the proof that also the states between the sampling instants t_i and $t_i + \delta$ do not leave Ω_α . The bound (5.21) implies that $x(t_i)$ reaches the set Ω_γ in finite time, for which (5.21) is not valid anymore.

$x(t_i) \in \Omega_\gamma$: To show that we can find ϵ such that $x(t_i + \tau) \in \Omega_\beta$, we use

³See Figure 5.3 for a clarification of the occurring regions.

again equation (5.20) and note that the state feedback trajectory satisfies $\bar{x}(t_i + \tau; x(t_i)) \in \Omega_\gamma$ for $\tau \in [0, \delta]$. Choosing an $\epsilon_3 \leq \min\{\epsilon_1, \epsilon_2\}$ sufficiently small, we know that for all $0 < \epsilon \leq \epsilon_3$, $V(x(t_i + \tau)) \leq \beta$ for $\tau \in [0, \delta]$, and for all $x(t_i) \in \Omega_\gamma$.

From the given arguments it follows that $x(t_i + \delta) \in \Omega_\beta$ for all $x(t_i) \in \Omega_\beta$ and $x(t_i + \tau) \in \Omega_\alpha$ for all $\tau \in [0, \delta]$. Thus it is clear that once $x(t_i)$ enters the set Ω_β , the trajectories stay for all times in $\Omega_\alpha \supset \Omega_\beta$.

Finite time convergence to Ω_β :

It remains to show that for any $(x_0, \eta_0) \in \mathcal{S} \times \mathcal{Q}$, there exists a (finite) sampling instant t_m with $x(t_m) \in \Omega_\beta$. We know from Theorem 5.1 that for sufficiently small δ and ϵ , $x(\tau) \in \Omega_c(\mathcal{S}) \forall \tau > 0$. Set $\delta_3^* = \delta_2^*$, and choose a $\delta < \delta_3^*$. Set $\epsilon_3^* = \min\{\epsilon_2^*, \epsilon_3\}$, where ϵ_2^* (dependent on δ) is specified as in Theorem 5.1.

Theorem 5.1 guarantees boundedness of $\eta(\tau) \forall \tau > 0$. To show convergence to Ω_β , note that (5.21) is valid for all $x(t_i) \in \Omega_c/\Omega_\gamma$. Therefore, for any initial condition in \mathcal{S} the state enters the set Ω_β in a finite time less than or equal to $\frac{c-\beta}{\kappa_2}\delta$. ■

Figure 5.3 clarifies some of the regions occurring in the proof.

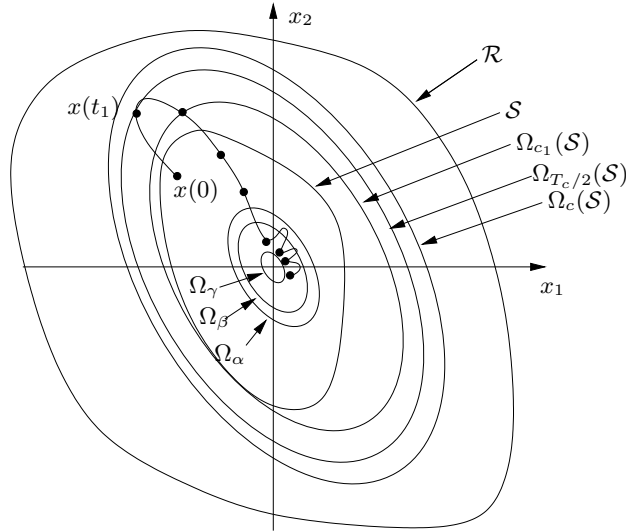

Figure 5.3: Regions involved in the practical stability proof.

Remark 5.5 *Theorem 5.2 implies practical stability of the system state $x(t)$. Choosing α and ϵ small enough, we can guarantee that x converges to any set containing a neighborhood the origin. Together with Theorem 5.1, this establishes that the closed-loop system state is semi-globally practically stable*

with respect to the set \mathcal{R} , in the sense that for any $\mathcal{S} \subset \mathcal{R}$ and any ball around the origin there exists an observer gain and a sampling period such that the system state reaches the ball from any point in \mathcal{S} in finite time and stays therein afterwards. Note, however, that with the given arguments we can only guarantee that the observer state stays bounded and converges at the end of each sampling interval to Γ_ϵ , $\eta(t_i^-) \in \Gamma_\epsilon$.

5.5 Convergence to the origin

In this section we show that under some strengthened assumptions, convergence to the origin holds. We use the results of Theorem 5.2, in that we place ourselves in a region $\Omega_\alpha \times \Gamma_\epsilon$ (where the size of Γ_ϵ is decided by $\epsilon_4^* \leq \epsilon_3^*$ to be defined in Theorem 5.3) at a sampling instant. Thus in this section we consider a fixed sampling period $\delta \leq \delta_3^*$, and $\epsilon \leq \epsilon_3^*$, where ϵ_3^* depends on δ .

We make the restrictive assumption that:

Assumption 5.8 *The mapping \mathcal{H} does not depend on the input (or the input derivatives).*

This assumption ensures that the observer state trajectory is time continuous over sampling instants since the jumps in the input does not affect the states in observability normal form directly and the observer is not dependent on the input derivatives. Also, as we will see, it is not necessary to reinitialize the observer as in the previous section, since we can show that the scaled observer error will not leave Γ_ϵ . Hence the output feedback scheme we consider in this section is as specified in Section 5.3.3, but without the reinitialization in (5.11).

Essentially, Assumption 5.8 means that we in this section consider full relative degree systems, similarly to Chapter 4. Larger system classes can be considered if continuity of the observer states is ensured, for instance by adding input integrators to the model as outlined in Section 5.3.2. This is not considered in further detail.

We can now show that Γ_ϵ is “invariant”:

Lemma 5.3 *Under Assumption 5.8, $\eta(t_i) \in \Gamma_\epsilon$ implies that $\eta(t) \in \Gamma_\epsilon$ for all $t > t_i$.*

Proof. From the proof of Lemma 5.1, $\eta(t)$ will not leave Γ_ϵ the first sampling interval after t_i . Since $\eta(t)$ is continuous, $\eta(t_{i+1}) \in \Gamma_\epsilon$. The result hold by an induction argument. ■

Combined with the result of Theorem 5.2, we conclude that $\Omega_\alpha \times \Gamma_\epsilon$ is invariant, and we confine us to this set for the rest of this section.

In this section, we need a stronger bound on $g(t, x(t), x(t_i), \eta(t), \eta(t_i^-))$ than merely the upper bound in (5.14):

Assumption 5.9 *For $(x(t), \eta(t)) \in \Omega_\alpha \times \Gamma_{\epsilon_3^*}$, there exists a $L_g > 0$ such that*

$$\|g(t, x(t), x(t_i), \eta(t), \eta(t_i^-))\| \leq L_g \|\eta(t)\|.$$

The above is true if the observer (5.7) is used, and the observer nonlinearity is the same as in the real system⁴. Note that it is crucial that the states and observer error are confined to the compact set $\Omega_\alpha \times \Gamma_{\epsilon_3^*}$, since Assumption 5.9 can only hold (with a fixed L_g) on a given compact set.

We also need to strengthen Assumption 5.3.1:

Assumption 5.10 *In addition to fulfilling Assumption 5.3.1, the stage cost is locally Lipschitz in both its arguments.*

The following lemma says that if the observer error is nonzero at a sampling instant, it will not become zero in the following sample interval. This is used to show that the Lipschitz continuity of the control in the observer error at sample instants (which follows from Assumption 5.3.2) can be replaced with Lipschitz continuity of the control in the “present” observer error.

Lemma 5.4 *Let Assumption 5.9 hold. For $(x(t_i), \eta(t_i)) \in \Omega_\alpha \times \Gamma_\epsilon$, and for $\tau \in [t_i, t_{i+1}]$,*

$$\|\eta(\tau)\| \geq L_\eta \|\eta(t_i)\|$$

for some $L_\eta > 0$.

Proof. By the definition of P_0 ,

$$\frac{\partial W}{\partial \eta} A_0 \eta = -\|\eta\|^2.$$

Because of this,

$$\frac{\partial W}{\partial \eta} \dot{\eta}(t) = -\frac{1}{\epsilon} \|\eta(t)\|^2 + \frac{\partial W}{\partial \eta} B g(t, x(t), x(t_i), \eta(t), \eta(t_i^-))$$

which by Assumption 5.9 means that

$$\begin{aligned} \dot{W} &\geq -\left(\frac{1}{\epsilon} + 2\|P_0\|L_g\right)\|\eta\|^2 \\ &\geq -\left(\frac{1}{\epsilon} + 2\|P_0\|L_g\right)\frac{1}{\|P_0\|}W(\eta) \\ &= -kW(\eta) \end{aligned}$$

⁴By Assumption 5.5, this implies that ϕ must be globally bounded. However, this is not a real limitation. Since Assumption 5.9 only needs to hold on a compact set, the nonlinearities only need to be equal on this set, and therefore we can bound the observer nonlinearity outside a compact set of interest.

for $k = (\|P_0\|\epsilon)^{-1} + 2L_g$. By the Comparison Lemma (Khalil, 1996), this implies that for $t > t_i$,

$$W(\eta(t)) \geq W(\eta(t_i)) \exp[-k(t - t_i)].$$

Thus, for $\tau \in [t_i, t_{i+1}]$,

$$\begin{aligned} \|\eta(\tau)\| &\geq \frac{1}{\|P_0\|} W(\eta(\tau)) \\ &\geq \frac{1}{\|P_0\|} W(\eta(t_i)) \exp[-k(\tau - t_i)] \\ &\geq \frac{\lambda_{\min}(P_0)}{\|P_0\|} \|\eta(t_i)\| \exp[-k(t_{i+1} - t_i)]. \end{aligned}$$

Choosing $L_\eta = \frac{\lambda_{\min}(P_0)}{\|P_0\|} \exp[-k\delta]$ completes the proof. ■

The following lemma is a refinement of Lemma 5.2 which holds due to the added assumptions and Lemma 5.4, and since we know that the states and observer error stay in a bounded set:

Lemma 5.5 *Consider the system (5.1) driven by the NMPC open-loop control law (5.4) using the correct state x_0 (state feedback) and the state estimate $\hat{x}_0 = \mathcal{H}^{-1}(\mathcal{H}(x_0) - D_\epsilon \eta_0)$ (output feedback)*

$$\dot{x}(\tau) = f(x(\tau), u(\tau; \hat{x}_0)), \quad \dot{\bar{x}}(\tau) = f(\bar{x}(\tau), u(\tau; x_0)), \quad x(t) = \bar{x}(t) = x_0,$$

with $(x(\tau), \eta(\tau)) \in \Omega_\alpha \times \Gamma_\epsilon$ and $\bar{x}(\tau) \in \Omega_\alpha$ for all $t \leq \tau \leq t + T$, for some $T < T_p$. Then, under the assumptions made, there exist constants L_1 and L_2 such that

$$\left| \int_t^{t+T} F(x(\tau), u(\tau; \hat{x}_0)) d\tau - \int_t^{t+T} F(\bar{x}(\tau), u(\tau; x_0)) d\tau \right| \leq L_1 \int_t^{t+T} \|\eta(\tau)\| d\tau \quad (5.22)$$

and

$$|V(x(t+T)) - V(\bar{x}(t+T))| \leq L_2 \int_t^{t+T} \|\eta(\tau)\| d\tau. \quad (5.23)$$

Proof. First note that the results of Lemma 5.2 holds on $[0, T]$ since the state trajectories are confined to Ω_α . This implies that

$$\|x(\tau) - \bar{x}(\tau)\| \leq \frac{L_{fu}L_u}{L_{fx}} \|x_0 - \hat{x}_0\| (e^{L_{fx}T} - 1), \quad \tau \in [t, t+T].$$

By Lemma 5.4 and Remark 5.4, we conclude that for $\tilde{L}_x = \frac{L_{fu}L_uL_{\mathcal{H}}}{L_{fx}L_\eta} (e^{L_{fx}T} - 1)$,

$$\|x(\tau) - \bar{x}(\tau)\| \leq \tilde{L}_x \|\eta(\tau)\|, \quad \tau \in [t, t+T]. \quad (5.24)$$

From Assumption 5.3.2,

$$\|u(\tau; \hat{x}_0) - u(\tau; x_0)\| \leq L_u \|\hat{x}_0 - x_0\|, \quad \tau \in [t, t + T_p],$$

which similarly implies (by Lemma 5.4 and Remark 5.4) that there exists a \tilde{L}_u such that

$$\|u(\tau; \hat{x}_0) - u(\tau; x_0)\| \leq \tilde{L}_u \|\eta(\tau)\|, \quad \tau \in [t, t + T_p]. \quad (5.25)$$

For (5.22) to hold it suffices to note that

$$|F(x(\tau), u(\tau; \hat{x}_0)) - F(\bar{x}(\tau), u(\tau; x_0))| \leq L_1 \|\eta(\tau)\| \quad \forall \tau \in [t, t + T],$$

for some $L_1 > 0$, which follows from (5.24) and (5.25) and Assumption 5.10 (note that $x(\tau)$ and $\bar{x}(\tau)$ stay within compact sets). Similarly, (5.23) follows from (5.24) and that V is locally Lipschitz (Assumption 5.3.3). ■

We are now ready to state the convergence result:

Theorem 5.3 (Convergence) *Let the compact sets \mathcal{Q} , \mathcal{S} and $\Omega_c(\mathcal{S})$ with $\mathcal{Q} \subset \mathbb{R}^n$ and $\mathcal{S} \subset \Omega_c(\mathcal{S}) \subset \mathcal{R}$ be given. Let the Assumptions 5.1-5.10 hold. Then there exists $\delta_4^* > 0$ such that for a $0 < \delta \leq \delta_4^*$, there exists $\epsilon_4^* > 0$ (dependent on δ) such that for all $0 < \epsilon \leq \epsilon_4^*$, and all $(x_0, \eta_0) \in \mathcal{S} \times \mathcal{Q}$, the trajectories $(x(t), \eta(t))$ stay bounded and converge to the origin.*

Proof. Let $0 < \tilde{\epsilon}_4$ be such that

$$L_1 + L_2 + \frac{L_g \|P_0\|}{\sqrt{\lambda_{\min}(P_0)}} \leq \frac{1}{4\tilde{\epsilon}_4 \sqrt{\|P_0\|}}.$$

Let t' , $\tilde{\epsilon}_3$ and $\tilde{\delta}_3$ be given according to Theorem 5.2 such that for a $0 < \delta \leq \tilde{\delta}_3$, there exist $0 < \epsilon \leq \tilde{\epsilon}_3$ such that the trajectories are confined to a set $\Omega_\alpha \subset \mathcal{S}$ for $t > t'$. Set $\epsilon_4^* := \min(\tilde{\epsilon}_3, \tilde{\epsilon}_4)$, and set $\delta_4^* = \tilde{\delta}_3$. Below, we consider the sampling instant $t_i > t'$ closest to t' . First, we want to get an estimate for the decrease of the observer error on integral form. It will be convenient to express this by the square root of W . It follows that

$$\begin{aligned} \frac{d}{dt} \sqrt{W(\eta(t))} &= \frac{\partial W}{\partial \eta} \left[\frac{1}{\epsilon} A_0 \eta(t) + Bg(t, x(t), x(t_i), \eta(t), \eta(t_i^-)) \right] \frac{1}{2\sqrt{W(\eta(t))}} \\ &\leq -\frac{1}{2\epsilon \sqrt{\|P_0\|}} \|\eta(t)\| \\ &\quad + 2\|P_0\| \|\eta(t)\| \|g(t, x(t), x(t_i), \eta(t), \eta(t_i^-))\| \frac{1}{2\sqrt{\lambda_{\min}(P_0)} \|\eta(t)\|} \\ &\leq -\frac{1}{2\epsilon \sqrt{\|P_0\|}} \|\eta(t)\| + \frac{L_g \|P_0\|}{\sqrt{\lambda_{\min}(P_0)}} \|\eta(t)\|, \end{aligned}$$

where both terms on the right hand side are linear in $\|\eta(t)\|$. Integrating this, we get that for any finite $0 < T \leq \delta$,

$$\begin{aligned} & \sqrt{W(\eta(t_i + T))} - \sqrt{W(\eta(t_i))} \\ & \leq \int_{t_i}^{t_i+T} -\frac{1}{2\epsilon\sqrt{\|P_0\|}}\|\eta(\tau)\| + \frac{L_g\|P_0\|}{\sqrt{\lambda_{\min}(P_0)}}\|\eta(\tau)\|d\tau. \end{aligned}$$

We define a ‘‘Lyapunov function’’ for the system with the observer, $\tilde{V}(x, \eta) := V(x) + \sqrt{W(\eta)}$, which by the properties of V and continuity in time of $x(t)$ and $\eta(t)$ is time continuous. Let $\bar{x}(t)$ be the state feedback trajectory, as in Lemma 5.5. Then, for some $0 < T \leq \delta$,

$$\begin{aligned} & \tilde{V}(x(t_i + T), \eta(t_i + T)) - \tilde{V}(x(t_i), \eta(t_i)) \\ & = V(x(t_i + T)) - V(x(t_i)) + \sqrt{W(\eta(t_i + T))} - \sqrt{W(\eta(t_i))} \\ & \leq V(\bar{x}(t_i + T)) - V(x(t_i)) + |V(x(t_i + T)) - V(\bar{x}(t_i + T))| \\ & \quad + \sqrt{W(\eta(t_i + T))} - \sqrt{W(\eta(t_i))}. \end{aligned}$$

From Assumption 5.3.4, it follows that

$$\begin{aligned} & \tilde{V}(x(t_i + T), \eta(t_i + T)) - \tilde{V}(x(t_i), \eta(t_i)) \\ & \leq - \int_{t_i}^{t_i+T} F(\bar{x}(\tau), u(\tau; x_0))d\tau \\ & \quad + |V(x(t_i + T)) - V(\bar{x}(t_i + T))| + \sqrt{W(\eta(t_i + T))} - \sqrt{W(\eta(t_i))} \\ & \leq - \int_{t_i}^{t_i+T} F(x(\tau), u(\tau; \hat{x}_0))d\tau \\ & \quad + \left| \int_{t_i}^{t_i+T} F(x(\tau), u(\tau; \hat{x}_0))d\tau - \int_{t_i}^{t_i+T} F(\bar{x}(\tau), u(\tau; x_0))d\tau \right| \\ & \quad + |V(x(t_i + T)) - V(\bar{x}(t_i + T))| + \sqrt{W(\eta(t_i + T))} - \sqrt{W(\eta(t_i))} \\ & \leq - \int_{t_i}^{t_i+T} F(x(\tau), u(\tau; \hat{x}_0))d\tau \\ & \quad + L_1 \int_{t_i}^{t_i+T} \|\eta(\tau)\|d\tau + L_2 \int_{t_i}^{t_i+T} \|\eta(\tau)\|d\tau \\ & \quad + \int_{t_i}^{t_i+T} -\frac{1}{2\epsilon\sqrt{\|P_0\|}}\|\eta(\tau)\| + \frac{L_g\|P_0\|}{\sqrt{\lambda_{\min}(P_0)}}\|\eta(\tau)\|d\tau \end{aligned}$$

where Lemma 5.5 is used in the last transition⁵.

⁵Note that since $x(\tau)$ stays within Ω_α , so will also $\bar{x}(\tau)$. This follows from the ‘‘worst case’’ approach of the proof of Theorem 5.2.

By the definition of ϵ_4^* , we have that for $0 < \epsilon \leq \epsilon_4^*$, $0 < T \leq \delta$,

$$\begin{aligned} & \tilde{V}(x(t_i + T), \eta(t_i + T)) - \tilde{V}(x(t_i), \eta(t_i)) \\ & \leq - \int_{t_i}^{t_i+T} F(x(\tau), u(\tau; \hat{x}_0)) d\tau - \int_{t_i}^{t_i+T} \frac{1}{4\epsilon\sqrt{\|P_0\|}} \|\eta(\tau)\| d\tau. \end{aligned}$$

In particular this holds for $T = \delta$. Since, by Theorem 5.1 and Lemma 5.3, we will not leave the set $\Omega_\alpha \times \Gamma_\epsilon$, the above holds for all remaining sample intervals (using the same ϵ). This shows that \tilde{V} is non-increasing. Together with continuity and the fact that \tilde{V} is bounded from below, this implies that the limit $\tilde{V}(x(\infty), \eta(\infty))$ exists. By adding all sample intervals together, we obtain in the limit

$$\begin{aligned} & \tilde{V}(x(\infty), \eta(\infty)) - \tilde{V}(x(t_i), \eta(t_i)) \\ & \leq - \int_{t_i}^{\infty} F(x(\tau), u(\tau; \hat{x}_0)) d\tau - \int_{t_i}^{\infty} \frac{1}{4\epsilon\sqrt{\|P_0\|}} \|\eta(\tau)\| d\tau \\ & \leq - \int_{t_i}^{\infty} \alpha_F(\|x(\tau)\|) + \frac{1}{4\epsilon\sqrt{\|P_0\|}} \|\eta(\tau)\| d\tau. \end{aligned}$$

This implies that the infinite integral on the right hand side exists and is finite. Noting the continuity (in time) of the involved functions, convergence of $(x(t), \eta(t))$ to $(0, 0)$ follows from Barbalat's Lemma (Khalil, 1996). ■

5.6 Discussion

The presented results allow application of state feedback NMPC for the output feedback stabilization problem. The derived results are mainly based on the fact that NMPC is to some extent robust to measurement errors. This robustness is restricted by the integral contribution on the right hand side of equation (5.18). Using this robustness in the output feedback case has some direct consequences. For example the level sets of the value function are invariant in the state feedback case, but are in general no longer invariant in the output feedback case. Trajectories starting in a level set might leave the level set between sampling instants, as is sketched in Figure 5.3 (see the proof of Theorem 5.1).

A generalization of this robustness is pursued in Findeisen (2002).

The outlined approach satisfies the state and input constraints. Satisfaction of input constraints is guaranteed by the NMPC scheme and boundedness of the input for $\hat{x} \notin \mathcal{R}$, see Assumption 5.7. The state constraints are satisfied since $\mathcal{S} \subset \mathcal{R} \subseteq \mathcal{X}$ and since a sufficiently high observer gain and a

sufficiently small sampling period is chosen such that even initially, the state does not leave the set $\mathcal{R} \subseteq \mathcal{X}$. Compare also Figure 5.3.

Note that in the presented approach, the sampling period must only be small enough to guarantee that the trajectory during the initial phase, for which the observer error is often significant, does not leave the region $\Omega_\epsilon(\mathcal{S})$. Beyond this, only ϵ must be further decreased to achieve the practical stability, while δ can be kept constant. This is a consequence of the usage of a predictive control scheme that uses a system model. The open-loop input signal applied to the system (which in general is not fixed to a constant value) corresponds to the predicted/desired behavior. In comparison, the general output feedback approach presented in Shim and Teel (2001b,a) requires a sufficient decrease in the sampling period to achieve practical stability. This stems from the fact that the input during the sampling interval is fixed to the constant value $u(t) = k(x(t_i))$ given by the state feedback controller $k(x)$.

In the general case, the approach requires knowledge of the inverse of the observability mapping. Finding this inverse can be hard in practical examples. An approach is outlined where the inverse is not explicitly needed.

In the proof of practical stability, the properties of the observer is only needed at the sampling instants. Hence, it seems natural that other observers with similar convergence properties also could be used, possibly for more general classes of systems. One obvious choice would be the moving horizon observer with enforced contraction rate of Michalska and Mayne (1995), but this observer needs global optimization in the general case.

In the general case, we only establish that the observer error stays bounded and converges at the end of each sampling interval to Γ_ϵ . This limitation is a direct result of the fact that we allowed a general observability map which depends on u and its derivatives. Since in NMPC the implemented input in general is discontinuous at the sampling instants, the scaled observer error η will also be discontinuous. Furthermore, even though the observer states will not be discontinuous, when transformed back to the original coordinates (\hat{x}), discontinuity will in general appear at the sampling instant. Since $\hat{x}(t_i)$ can be outside of \mathcal{Q} , and η might “jump” out of Γ_ϵ at the sampling instant, we have to ensure that $\hat{x}(t_i)$ is inside of \mathcal{Q} to guarantee that η converges again to the set Γ_ϵ for t_{i+1}^- . This is the key reason making the reinitialization of the observer state necessary if $\hat{x}(t_i) \notin \mathcal{Q}$. It should be noted that the scaled observer error η will in general be discontinuous independently of this reinitialization, hence the observer has to be analyzed repeatedly at each sampling instant anyway.

When \mathcal{H} is independent of u (as is assumed in Section 5.5), or when the inputs do not have discontinuity, e.g. due to some added integrators at the input side, the reinitialization is not necessary, and η becomes continuous.

In this case, as is apparent from the proof of Lemma 5.1 (see Lemma 5.3), the observer error converges after one sampling interval to Γ_ϵ and stays there indefinitely, thus the whole closed loop including the observer states is practically stable. The case where \mathcal{H} does not depend on u appears for example if the system has a full vector relative degree.

The example (the inverted pendulum, nominal case) of the previous chapter (Section 4.7) can also be taken as an example of the approach of this chapter, since sampling (more or less inevitably) was used in the simulation. The system class and observer used in that example satisfies the assumptions of Section 5.5.

5.7 Conclusions

It is a widespread intuition that NMPC, which inherently is a state feedback approach, can be applied to systems where only output measurements are available, if an observer with “good enough” convergence properties is used. In this chapter, a new output feedback NMPC scheme for the class of uniformly completely observable systems is derived, using a high-gain observer to obtain “fast enough” estimates of the states. It is shown that under certain assumptions on the NMPC controller, the approach confirms the intuition.

The state estimates are used at sampling instants to calculate an open-loop input signal that is applied to the system during the next sampling interval. Feedback is achieved since updated information is used at each sample instant. The output feedback scheme obtains semi-global practical stability of the system states, that is, for a fast enough sampling frequency and fast enough observer, it recovers to a desired accuracy the NMPC state feedback region of attraction (semi-global) and steers the system state to any (small) compact set containing the origin (practical stability).

The semi-global stability result obtained are the key difference to previous output feedback NMPC schemes, delivering direct tuning knobs to increase the resulting region of attraction of the closed loop.

No specific state feedback NMPC scheme is considered during the derivations. Instead a set of assumptions are stated that the NMPC scheme must fulfill. In principle these assumptions can be satisfied by a series of NMPC schemes, such as quasi-infinite horizon NMPC (Chen and Allgöwer, 1998b), zero terminal constraint NMPC (Mayne and Michalska, 1990) and NMPC schemes using control Lyapunov functions to obtain stability (Jadbabaie et al., 2001, Primbs et al., 1999). Still a series of open questions for output feedback NMPC remain. For example one of the key assumptions on the NMPC controller is that the applied optimal open-loop input is locally Lips-

chitz in terms of the state. This assumption is in general hard to verify. Thus future research should focus on either relaxing this condition, or to derive conditions under which an NMPC scheme does satisfy this assumption.

If the input does not appear in the observability map, the NMPC controller need not be modified to guarantee that the input is sufficiently smooth. Thus, in this case the derived results can be seen as a special separation principle for NMPC.

The derived results should be considered as conceptual rather than directly applicable in practice. Many open questions remain for a successful application. For example the influence of measurement noise, which certainly plays an important role in practical applications, has not been considered.

Part III

State Feedback Control of Positive Systems

Chapter 6

A State Feedback “Total Mass” Controller for a Class of Positive Systems

6.1 Introduction

Positive systems are dynamical systems that are described by ODEs where the state variables are confined to the first orthant, that is, the state variables are non-negative. Such systems have been studied for a long time, see for instance Luenberger (1979) for an introduction. It appears *linear* positive systems have gained most interest, see for instance Bru, Caccetta, Romero, Rumchev and Sánchez (2002), Farina (2002) for two recent overviews. Physical systems subject to control will often be described by *nonlinear* positive systems from first principles modeling.

Since mass is an inherently positive quantity, systems modeled by mass balances (Bastin, 1999) are perhaps the most natural example of positive systems. Another example is the widely studied class of compartmental systems (Godfrey, 1983, Jacquez and Simon, 1993), used in biomedicine, pharmacokinetics, ecology, etc. Compartmental systems, which are often derived from mass balances, are (nonlinear or linear) systems where the dynamics are subject to strong structural constraints. Each state is a measure of some material in a compartment, and the dynamics consists of the flow of material into (*inflow*) or out of (*outflow*) each compartment. If these flows fulfill certain criteria, the system is called compartmental.

Similar to compartmental systems, we will assume that each state can be interpreted as the “mass” (or measure of mass; concentration, level, pressure, etc.) of a compartment. However, we do not make the same strong assump-

tions on the structure on the flows between the compartments. Instead, we make other (strong) assumptions related to the system being controllable according to the control objective under input saturations.

We assume that the compartments that constitute the state can be divided into groups of compartments, which we will call *phases*. Each phase will have a controlled inflow or outflow associated with it. The control objective will be to steer the mass of each phase (the sum of the compartment masses in that phase) to a constant, prespecified value.

The developed state feedback controller is similar to (and to a degree inspired by) Bastin and Praly (1999). However, a larger class of systems is treated, multiple inputs are allowed, and the inputs can be saturated. Similar to Bastin and Praly (1999), the input is positive, and aims to achieve a constant total mass. The controller in Bastin and Praly (1999) (recently expanded in the direction of compartmental systems in Bastin and Provost (2002)) can be viewed as a special case of the controller herein.

The approach in De Leenheer and Aeyels (2002) considers systems where the uncontrolled system has *first integrals*, that is, functions of the state that remain constant as the state changes. A typical example of a first integral is the total mass of a mass-balance system with no external flows. In De Leenheer and Aeyels (2002), general first integrals $H(x)$ are considered. The controller developed in De Leenheer and Aeyels (2002) aims at controlling the first integral to a level set of the first integral, that is, $H(x) = C$ for some $C > 0$. Since the aim herein is to stabilize (in the case of one phase) the total mass ($M(x)$) at $M(x) = C$, some similarities are inevitable. For example, the Lyapunov function is essentially the same, and the same tool (LaSalle's invariance principle) is used. However, the system class is different (the system class herein does not in general have first integrals) and the controller is different; in particular the controller in De Leenheer and Aeyels (2002) can take both positive and negative values.

In Sontag (2001), the structure of a certain class of positive nonlinear systems occurring in the analysis of chemical networks is studied, and results on stability, robustness and stabilization are given. The (uncontrolled) system class, "deficiency zero chemical reaction networks with mass-action kinetics" has first integrals, and the controlled version can be contained in the system class herein. However, Sontag (2001) only considers inflow-controlled systems affine in the control, but (as is stated in Sontag (2001)) "bilinear control action is arguably more interesting in reaction systems". The approach herein covers this, as demonstrated by an example considering the Van der Vusse reaction scheme.

The chapter is structured as follows: In Section 6.2 the system class is presented, while the controller and a convergence result from a general

invariant domain of attraction are presented in Section 6.3. Some possible regions of attractions are also presented. Section 6.4 gives some remarks on stability of equilibria and sets, and a robustness property is demonstrated. Some simple examples are presented in Section 6.5, while the example that inspired the development of the controller is presented in Section 6.6.

In the following, $\mathbb{R}_+ = [0, \infty)$ and $\mathbb{R}_+^n = \{x = [x_1, x_2, \dots, x_n]^\top \mid x_i \in \mathbb{R}_+\}$. Further, $\text{blockdiag}(A_1, \dots, A_r)$ defines a block diagonal matrix with the matrices A_1, \dots, A_r on the “diagonal”.

6.2 Model class

We consider positive systems

$$\dot{x} = f(x, u), \quad (6.1a)$$

that is, the state is positive ($x \in \mathbb{R}_+^n$), and the input is positive and upper bounded, $u \in U := \{u \in \mathbb{R}_+^m \mid 0 \leq u_j \leq \bar{u}_j\}$.

The system class has the following structure:

$$f(x, u) = \Phi(x) + \Psi(x) + B(x)u. \quad (6.1b)$$

Each state can be interpreted as the “mass” (amount of material, or some measure of amount) in a compartment¹. Loosely speaking, $\Phi(x)$ represents the “interconnection structure” between compartments, $\Psi(x)$ represents *uncontrolled* external inflows to and outflows from compartments and $B(x)u$ represents *controlled* external inflows to and outflows from compartments.

Furthermore, we will assume that the state can be divided into m different parts, which will be called *phases*. Phase j will consist of r_j states, and have the control u_j associated with it, corresponding to *either* controlled inflow *or* outflow to compartments of that phase. The states in phase j is called z^j , such that $x = [(z^1)^\top, (z^2)^\top, \dots, (z^m)^\top]^\top$, and it follows that necessarily, $\sum_{j=1}^m r_j = n$. Corresponding to this structure, the vector functions $\Phi(x)$, $\Psi(x)$ and the matrix function $B(x)$ are on the form

$$\begin{aligned} \Phi(x) &= \left[\phi^1(x)^\top, \phi^2(x)^\top, \dots, \phi^m(x)^\top \right]^\top \\ \Psi(x) &= \left[\psi^1(x)^\top, \psi^2(x)^\top, \dots, \psi^m(x)^\top \right]^\top \\ B(x) &= \text{blockdiag} (b^1(x), b^2(x), \dots, b^m(x)). \end{aligned}$$

¹The word compartment *does not* imply that the system class we look at is compartmental (Jacquez and Simon, 1993). However, it enjoys strong similarities with compartmental systems.

Note that element j is (in general) function of x , not (only) z^j . Also note that the partitioning into phases need not be unique.

We will state the assumptions on these functions on the set $D \subseteq \mathbb{R}_+^n$. In the case of global results, $D = \mathbb{R}_+^n$.

- A1. **(Interconnection structure)** The function $\Phi : D \rightarrow \mathbb{R}^n$ is locally Lipschitz, $\phi_i^j(x) \geq 0$ for $z_i^j = 0$, and

$$\sum_{i=1}^{r_j} \phi_i^j(x) = 0, \quad j = 1, \dots, m.$$

- A2. **(Controlled external flows)** The block diagonal matrix function $B(x) : D \rightarrow \mathbb{R}^{n \times m}$ is locally Lipschitz and satisfies:

- a. Phase j has controlled inflow:

$$\begin{aligned} b_i^j(x) &\geq 0 \text{ for all } x \in D \\ b_i^j(x) &> 0 \text{ for all } x \in D \text{ for at least one } i \end{aligned}$$

- b. Phase j has controlled outflow:

$$\begin{aligned} b_i^j(x) &\leq 0 \text{ for all } x \in D \\ \text{if } \exists x \in D \text{ such that } z_i^j &= 0, \text{ then } z_i^j = 0 \Rightarrow b_i^j(x) = 0 \\ b_i^j(x) &< 0 \text{ for all } x \in D \text{ with } z_i^j \neq 0, \text{ for at least one } i \end{aligned}$$

The uncontrolled external flows must satisfy some ‘‘controllability’’ assumption in relation to the controlled flows. Before we define this, it is convenient to define the ‘‘mass’’ of each phase, being the sum of the compartment masses of that phase:

$$M_j(x) := \sum_{i=1}^{r_j} z_i^j.$$

Our control objective will be to control $M_j(x)$ to some prespecified desired mass of phase j , denoted M_j^* , from initial conditions in D . For the control problem to be meaningful, the intersection of the set where $M_j(x) = M_j^*$ and D should be nonempty.

- A3. **(Uncontrolled external flows)** For given $M^* = [M_1^*, M_2^*, \dots, M_m^*]^\top$, $\Psi(x) : D \rightarrow \mathbb{R}^n$ is locally Lipschitz and satisfies that $\psi_i^j(x) \geq 0$ for $z_i^j = 0$, and in addition, if:

- a. Phase j has controlled inflow:
1. For $x \in \{x \in D \mid M_j(x) > M_j^*\}$, $\sum_{i=1}^{r_j} \psi_i^j(x) \leq 0$ and the set $\{x \in D \mid \sum_{i=1}^{r_j} \psi_i^j(x) = 0 \text{ and } M_j(x) > M_j^*\}$ does not contain an invariant set.
 2. For $x \in \{x \in D \mid M_j(x) < M_j^*\}$, $-\sum_{i=1}^{r_j} \psi_i^j(x) < \sum_{i=1}^{r_j} b_i^j(x) \bar{u}_j$.
- b. Phase j has controlled outflow:
1. For $x \in \{x \in D \mid M_j(x) < M_j^*\}$, $\sum_{i=1}^{r_j} \psi_i^j(x) \geq 0$ and the set $\{x \in D \mid \sum_{i=1}^{r_j} \psi_i^j(x) = 0 \text{ and } M_j(x) < M_j^*\}$ does not contain an invariant set.
 2. For $x \in \{x \in D \mid M_j(x) > M_j^*\}$, $\sum_{i=1}^{r_j} \psi_i^j(x) < -\sum_{i=1}^{r_j} b_i^j(x) \bar{u}_j$.

We briefly note that the upper saturations \bar{u}_j can be state dependent, without affecting the main results. The chosen notation will not reflect this.

Remark 6.1 *The system class considered in Bastin and Praly (1999), is a sub-case of the system class considered herein with $D = \mathbb{R}_+^n$, one phase, controlled inflow and no upper bound on the input. The function $\Psi(x) = -Ax = -[a_1x_1, \dots, a_nx_n]^\top$, A diagonal with nonnegative (at least one positive) diagonal elements and, further, $B(x) = b$, a constant nonnegative vector with at least one positive element. Assumption A3 (which in this case amounts to A3.a.1) is replaced by the system being zero state detectable through the output $\sum_{i=1}^n a_ix_i$, which has the same effect as Assumption A3.a.1. The results of Bastin and Praly (1999) are expanded in the direction of compartmental systems in Bastin and Provost (2002).*

Remark 6.2 *The uncontrolled external flows might (partly or wholly) be flows between compartments in different phases, but the controlled external flows of one phase cannot (by the assumptions made) be flows in another phase.*

However, the approach could also cover this, by choosing one phase which is controlled by this flow, while in the other phase(s) this flow (which will given by the controller of the first phase) should be treated as an uncontrolled external flow (and assumptions corresponding to Assumption A3 should hold).

Proposition 6.1 (Positivity) *For $x(0) \in \mathbb{R}_+^n$, the state of the system (6.1) fulfilling A1-A3 with $D = \mathbb{R}_+^n$, satisfies $x(t) \in \mathbb{R}_+^n$, $t > 0$.*

Proof. It suffices to notice that for $x_i = 0$, $\dot{x}_i \geq 0$. ■

The system class is illustrated in Figure 6.1.

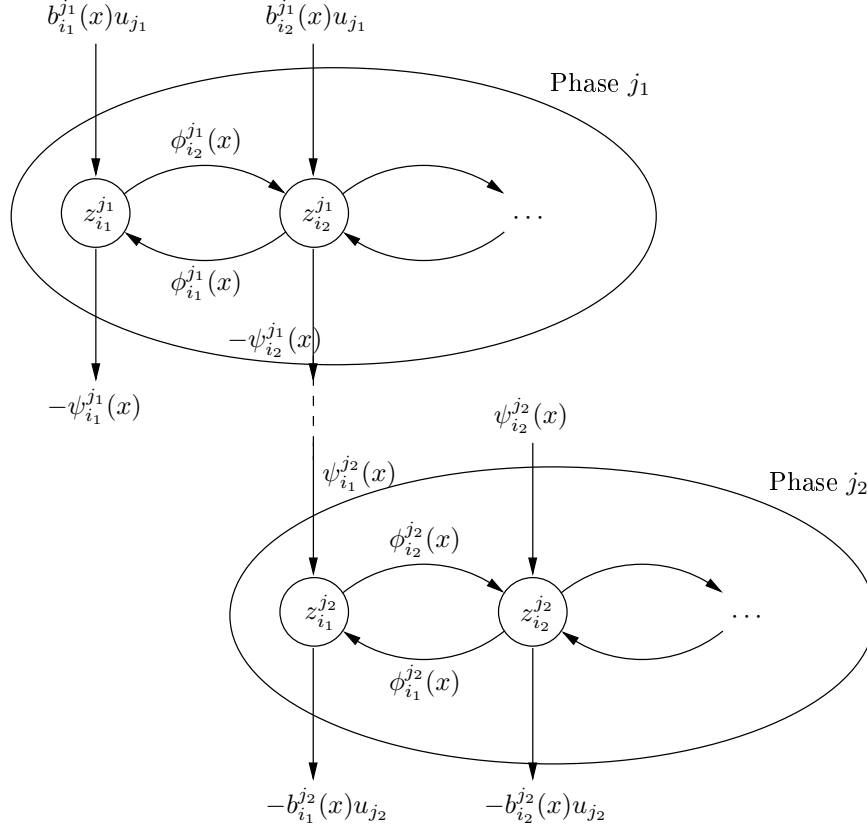

Figure 6.1: Illustration of the system class. Phase j_1 has controlled inflow, phase j_2 has controlled outflow. The uncontrolled external flows may be between phases.

6.3 State feedback total mass controller

In this section, the state feedback controller is defined, and a general convergence result is given for a general invariant set D that the assumptions hold on. The set D could then be considered a region of attraction. Corollaries of the main result specifies different set D that could be chosen, for instance $D = \mathbb{R}_+^n$.

6.3.1 The state feedback controller and a general convergence result

As mentioned in the previous section, our control objective is to control the total mass $M_j(x)$ of each phase to a prespecified value M_j^* .

To this end, the following constrained, positive state feedback control is proposed:

$$u_j(x) = \begin{cases} 0 & \text{if } \tilde{u}_j(x) < 0 \\ \tilde{u}_j(x) & \text{if } 0 \leq \tilde{u}_j(x) \leq \bar{u}_j \\ \bar{u}_j & \text{if } \tilde{u}_j(x) > \bar{u}_j \end{cases} \quad (6.2)$$

where

$$\tilde{u}_j(x) = \frac{1}{\sum_{i=1}^{r_j} b_i^j(x)} \left(-\sum_{i=1}^{r_j} \psi_i^j(x) + \lambda_j(M_j^* - M_j(x)) \right) \quad (6.3)$$

and λ_j is a positive constant.

This controller can be seen as a generalization of the controller in Bastin and Praly (1999) to more general MIMO-systems, to systems with controlled outflow and to systems with upper constraints on the input. Apparently, we can run into situations where the control is not defined if phase j is outflow controlled, since the term $\sum_{i=1}^{r_j} b_i^j(x)$ then might be zero. However, the continuity of the involved functions and the upper bound on the control ensures that the control in these cases unambiguously are defined by $u_j(x) = \bar{u}_j$.

Define the set

$$\Omega = \{x \in \mathbb{R}_+^n \mid M_1(x) = M_1^*, \dots, M_m(x) = M_m^*\}. \quad (6.4)$$

Assumption 6.1 *There exists a set D that is invariant for the dynamics (6.1) under the closed loop with control (6.2), and has a nonempty intersection with Ω .*

Assumption 6.2 *For $x \in \Omega \cap D$, $0 < \tilde{u}_j(x) < \bar{u}_j$.*

Under the given assumptions, the convergence properties of the controller are summarized in the following Theorem:

Theorem 6.1 *Under Assumption 6.2 and 6.1, the state of the system (6.1), Assumptions A1, A2 and A3 holding, controlled with (6.2) and starting from some initial condition $x(0) \in D$, stays bounded and converges to the positively invariant set $\Omega \cap D$.*

Proof. The set D is by Assumption 6.1 invariant, hence Assumptions A1-A3 hold along closed loop trajectories.

Define the positive semidefinite function

$$V(x) := \frac{1}{2} \begin{bmatrix} M_1(x) - M_1^* \\ M_2(x) - M_2^* \\ \vdots \\ M_m(x) - M_m^* \end{bmatrix}^\top \begin{bmatrix} M_1(x) - M_1^* \\ M_2(x) - M_2^* \\ \vdots \\ M_m(x) - M_m^* \end{bmatrix} = \frac{1}{2} \sum_{j=1}^m (M_j(x) - M_j^*)^2, \quad (6.5)$$

with time derivative

$$\begin{aligned} \dot{V}(x) &= \sum_{j=1}^m [M_j(x) - M_j^*] \dot{M}_j(x) \\ &= \sum_{j=1}^m [M_j(x) - M_j^*] \left(\sum_{i=1}^{r_j} \phi_j^i(x) + \sum_{i=1}^{r_j} \psi_j^i(x) + \sum_{i=1}^{r_j} b_j^i(x) u_j(x) \right) \\ &= \sum_{j=1}^m [M_j(x) - M_j^*] \left(\sum_{i=1}^{r_j} \psi_j^i(x) + \sum_{i=1}^{r_j} b_j^i(x) u_j(x) \right). \end{aligned}$$

For $M_j(x) \neq M_j^*$, we have one of the following cases:

1. If $0 \leq \tilde{u}_j \leq \bar{u}_j$, summand j is

$$[M_j(x) - M_j^*] \left(\sum_{i=1}^{r_j} \psi_j^i(x) + \sum_{i=1}^{r_j} b_j^i(x) u_j(x) \right) = -\lambda_j [M_j(x) - M_j^*]^2 < 0.$$

2. If $\tilde{u}_j < 0$, then $u_j(x) = 0$ and summand j is

$$[M_j(x) - M_j^*] \sum_{i=1}^{r_j} \psi_j^i(x).$$

We check the negativity of this for phase j being both inflow and outflow controlled:

- a) If phase j has controlled inflow, then if $M_j(x) - M_j^* > 0$ by Assumption A3.a.1 $\sum_{i=1}^{r_j} \psi_j^i(x) < 0$, and

$$[M_j(x) - M_j^*] \sum_{i=1}^{r_j} \psi_j^i(x) \leq 0.$$

If $M_j(x) - M_j^* < 0$, then from $\tilde{u}_j(x) < 0$ we see that $\sum_{i=1}^{r_j} \psi_j^i(x) > -\lambda_j [M_j(x) - M_j^*]$ and we conclude

$$[M_j(x) - M_j^*] \sum_{i=1}^{r_j} \psi_j^i(x) \leq -\lambda_j [M_j(x) - M_j^*]^2 < 0.$$

b) If phase j has controlled outflow, then if $M_j(x) - M_j^* < 0$ by Assumption A3.b.1 $\sum_{i=1}^{r_j} \psi_j^i(x) > 0$, and

$$[M_j(x) - M_j^*] \sum_{i=1}^{r_j} \psi_j^i(x) \leq 0$$

If $M_j(x) - M_j^* > 0$, then from $\tilde{u}_j(x) < 0$ we see that $\sum_{i=1}^{r_j} \psi_j^i(x) < -\lambda_j [M_j(x) - M_j^*]$ and we conclude

$$[M_j(x) - M_j^*] \sum_{i=1}^{r_j} \psi_j^i(x) \leq -\lambda_j [M_j(x) - M_j^*]^2 < 0.$$

3. If $\tilde{u}_j \geq \bar{u}_j$, then $u_j(x) = \bar{u}_j$ and summand j is

$$[M_j(x) - M_j^*] \left(\sum_{i=1}^{r_j} \psi_j^i(x) + \sum_{i=1}^{r_j} b_j^i(x) \bar{u}_j \right).$$

a) If phase j has controlled inflow, then if $M_j(x) - M_j^* < 0$ by Assumption A3.a.2 $-\sum_{i=1}^{r_j} \psi_j^i(x) > \sum_{i=1}^{r_j} b_j^i(x) \bar{u}_j$, and

$$[M_j(x) - M_j^*] \left(\sum_{i=1}^{r_j} \psi_j^i(x) + \sum_{i=1}^{r_j} b_j^i(x) \bar{u}_j \right) < 0.$$

If $M_j(x) - M_j^* > 0$, from $\tilde{u}_j > \bar{u}_j$ we see that $\sum_{i=1}^{r_j} \psi_j^i(x) + \sum_{i=1}^{r_j} b_j^i(x) \bar{u}_j < -\lambda_j [M_j(x) - M_j^*]$ and

$$[M_j(x) - M_j^*] \left(\sum_{i=1}^{r_j} \psi_j^i(x) + \sum_{i=1}^{r_j} b_j^i(x) \bar{u}_j \right) < -\lambda_j [M_j(x) - M_j^*]^2 < 0.$$

b) If phase j has controlled outflow, then if $M_j(x) - M_j^* > 0$ by Assumption A3.b.2 $-\sum_{i=1}^{r_j} \psi_j^i(x) > \sum_{i=1}^{r_j} b_j^i(x) \bar{u}_j$, and

$$[M_j(x) - M_j^*] \left(\sum_{i=1}^{r_j} \psi_j^i(x) + \sum_{i=1}^{r_j} b_j^i(x) \bar{u}_j \right) < 0.$$

If $M_j(x) - M_j^* < 0$, from $\tilde{u}_j > \bar{u}_j$ we see that $\sum_{i=1}^{r_j} \psi_j^i(x) + \sum_{i=1}^{r_j} b_j^i(x)\bar{u}_j > -\lambda_j [M_j(x) - M_j^*]$ and

$$[M_j(x) - M_j^*] \left(\sum_{i=1}^{r_j} \psi_j^i(x) + \sum_{i=1}^{r_j} b_j^i(x)\bar{u}_j \right) < -\lambda_j [M_j(x) - M_j^*]^2 < 0.$$

We conclude that $\Omega \cap D$ is invariant, since for $x \in \Omega \cap D$, $V(x) = 0$ and by Assumption 6.2 and the above, $\dot{V}(x) < 0$ in the intersection between a neighborhood of $\Omega \cap D$ and the invariant set D .

Moreover, since $\dot{V}(x) \leq 0$, $V(x(t)) \leq V(x(t_0))$ along system trajectories. From the construction of $V(x)$ and invariance of $(D \subseteq) \mathbb{R}_+^n$, it is rather easy² to see that for $x \in \mathbb{R}_+^n$, $\|x\| \rightarrow \infty$ if and only if $V(x) \rightarrow \infty$, hence $V(x(t))$ bounded implies that $\|x(t)\|$ is bounded. This allows us to conclude from LaSalle's invariance principle that $x(t)$ converges to the largest invariant set contained in $\{x \mid \dot{V}(x) = 0\} \cap D$. By the above and Assumption A3.a.1 and A3.b.1, there is no other invariant set for which $\dot{V}(x) = 0$ other than $\Omega \cap D$. ■

Remark 6.3 *By inspecting the proof, we see that Assumption A3 can be made slightly weaker; A3.a.1 and A3.b.1 need only hold when $\tilde{u}_j = 0$, and A3.a.2 and A3.b.2 need only hold when $\tilde{u}_j = \bar{u}_j$. However, conditions like these are harder to check.*

Remark 6.4 *Since the mapping f is assumed locally Lipschitz, LaSalle's Theorem in the form stated in Khalil (2002) can be used directly. However, under a uniqueness assumption on (Filipov) solutions of $\dot{x} = f(x, u)$, the result holds for general nonsmooth f by the nonsmooth version of LaSalle's Theorem (Shevitz and Paden, 1994).*

6.3.2 Regions of attraction

The global result follows directly as a corollary of Theorem 6.1, with $D = \mathbb{R}_+^n$:

Corollary 6.1 (Global convergence) *Under Assumption 6.2, the state of the system (6.1), Assumptions A1, A2 and A3 holding with $D = \mathbb{R}_+^n$, controlled with (6.2) and starting from some initial condition $x(0) \in \mathbb{R}_+^n$, stays bounded and converges to the positively invariant set Ω .*

Corollary 6.1 achieves global results by assuming that Assumptions A1-A3 hold globally. However, (at least for A2 and A3) this will often not be the

²See Section 6.4.3.

case. In particular, to require A3.a.2 and A3.b.2 to hold globally is strong. For instance, controller saturations are typically designed to cope only with flow in a nominal operating range.

We note that (under Assumptions A1 and A2) as long as the control is unconstrained (that is, $u_j = \tilde{u}_j(x)$) and stays unconstrained along the closed loop trajectories, convergence to Ω will trivially hold since then $\dot{M}_j(x) = -\lambda_j \left(M_j^* - M_j(x) \right)^2$. This in itself can be interpreted as a “local” convergence result. Further, by inspecting the proof of Theorem 6.1, we see that convergence also holds when constraints are active as long as the conditions of Assumption A3 hold along system trajectories. However, the question remains, how to specify which initial conditions this is true for?

One answer is to let the assumptions hold on the (closed loop) invariant set D . Below, we give two choices of D that can be checked in applications.

Firstly, we let D be a “tube” (hyper-rectangle) containing Ω . Let \bar{c}_j and \underline{c}_j be positive constants, and define

$$D_1 := \{x \in \mathbb{R}_+^n \mid M_j^* - \underline{c}_j \leq M_j(x) \leq M_j^* + \bar{c}_j, j = 1, \dots, m\}. \quad (6.6)$$

Corollary 6.2 *Under Assumption 6.2, the state of the system (6.1), Assumptions A1, A2 and A3 holding with $D = D_1$, controlled with (6.2) and starting from some initial condition $x(0) \in D_1$, stays bounded and converges to the positively invariant set $\Omega \subset D_1$.*

Proof. Invariance of D_1 (which by construction contains Ω) can be shown using the same steps as in the proof of Theorem 6.1. Hence Assumption 6.1 holds, and the result follows from Theorem 6.1. ■

Remark 6.5 *The above is similar to taking a Lyapunov level set as region of attraction. Indeed, if $\bar{c}_j = \underline{c}_j = c_j$, then D_1 can be specified as $\{x \in \mathbb{R}_+^n \mid V_j(x) \leq \frac{c_j^2}{2}, j = 1, \dots, m\}$. See also Section 6.4.3, where it is shown that V can be interpreted as a Lyapunov function.*

The above relaxation does not help in many cases, as it can happen that the assumptions do not hold on all of Ω . Consider (for example) the outflow controlled ($b(x) \leq 0$) example

$$\begin{aligned} \dot{x}_1 &= \phi(x) + \psi(x) \\ \dot{x}_2 &= -\phi(x) + b(x)u, \end{aligned}$$

and assume $\Omega \subset D$. Now, Assumption 6.2 cannot hold, since x_2 can be zero on Ω , which implies $u = \bar{u}$. Also, the set of functions $\psi(x)$ that satisfies Assumption A3 in this case is very restricted.

However, the control law might still work for some initial conditions, if the (closed loop) dynamics keep the trajectories away from the regions where the assumptions do not hold. This is in general hard to specify.

Realizing that it will often be the “extreme” cases on Ω that causes problem (x_i close to 0 or M_j^*), the following can work in some situations: Define D_2 ,

$$D_2 := \{x \in \mathbb{R}_+^n \mid \underline{z}_j^i \leq z_j^i \leq \bar{z}_j^i, i = 1, \dots, r_j \text{ and} \\ M_j^* - \underline{c}_j \leq M_j(x) \leq M_j^* + \bar{c}_j, j = 1, \dots, m\}$$

and assume

Assumption 6.3 *The following holds for $x \in D_2$:*

$$z_j^i = \underline{z}_j^i \Rightarrow \dot{z}_j^i \geq 0 \quad (6.7)$$

$$z_j^i = \bar{z}_j^i \Rightarrow \dot{z}_j^i \leq 0. \quad (6.8)$$

Corollary 6.3 *Under Assumption 6.2 and 6.3, the state of the system (6.1), Assumptions A1, A2 and A3 holding with $D = D_2$, controlled with (6.2) and starting from some initial condition $x(0) \in D_2$, stays bounded and converges to the positively invariant set $\Omega \cap D_2$.*

Proof. Under Assumption 6.3, D_2 is invariant. The result then follows from Theorem 6.1. ■

The sets D_1 and D_2 are sketched in Figure 6.2 in the two-dimensional case.

Remark 6.6 *Note that for a pair i, j , \underline{z}_j^i can be zero, and/or \bar{z}_j^i can be ∞ . In this case, Assumption 6.3 (eq. (6.7) and/or (6.8)) does not have to hold for the pair i, j .*

6.3.3 Conservatism

The proof of Theorem 6.1 uses Assumption A3 to show that $V(x)$ is always decreasing. However, this is conservative in the sense that for some systems, there are initial conditions which do not fulfill the conditions of Assumption A3, but the closed loop trajectories will still converge to Ω . This can be explained by that the total mass goes further away from Ω initially, but after some initial time period the mass has “reconfigured” in the system to a state where the conditions of Assumption A3 holds along the (rest of the) trajectory.

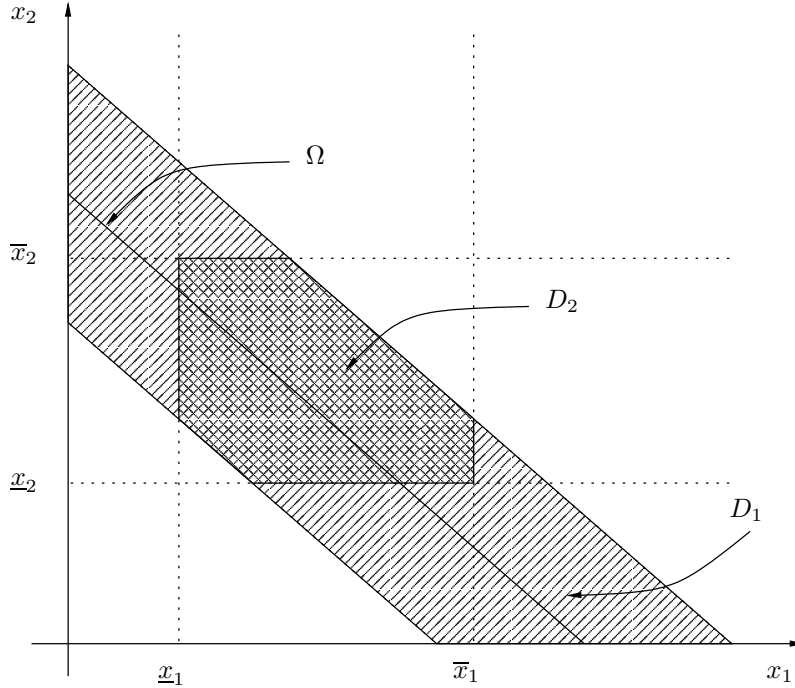
 Figure 6.2: The sets D_1 and D_2 .

6.4 Robustness and stability properties

6.4.1 Stability of equilibria

Convergence to the set Ω does not imply that the state converges to an asymptotically stable equilibrium, as we shall see by example. However, as other examples will show us, it often turns out that the only positive limit set in Ω is an equilibrium. This must in general be examined in each specific case, which can be a non-trivial task.

Since Theorem 6.1 implies that the positive limit set of every solution of the system (6.1) with feedback (6.2) is in Ω , it is tempting to conclude that the dynamic behavior *on* Ω decides the asymptotic behavior of the original system. However, this is not true in general³.

³The following example was provided by Robert Israel, which illustrates the issue (see also Iggidr, Kalitine and Outbib (1996) for a similar two-dimensional example). Consider $\dot{x} = -yz$, $\dot{y} = xz$, $\dot{z} = -z^3$. It is clear that all solutions converge to $z = 0$. The dynamics on the set $z = 0$ is $\dot{x} = \dot{y} = 0$, that is, the positive limit set is isolated points given by the initial conditions. However, the solutions of the full system are of the form (for $z(t_0) > 0$) $x(t) = A \sin(\sqrt{2t+C}) + B \cos(\sqrt{2t+C})$, $y(t) = -A \cos(\sqrt{2t+C}) +$

On the other hand, in the case of one equilibrium on Ω that is asymptotically stable and attractive for all initial conditions in Ω , the positive semidefiniteness of $V(x)$ in the proof of 6.1 implies that this equilibrium is also asymptotically stable for all initial conditions in D . This can be proved in exactly the same manner as Theorem 5 in De Leenheer and Aeyels (2002), we therefore state this theorem without proof:

Theorem 6.2 *Let the conditions of Theorem 6.1 hold. If the closed loop (6.1) has a single equilibrium in the interior of $\Omega \cap D$ that is asymptotically stable with respect to initial conditions in $\Omega \cap D$ and attractive for all initial conditions in $\Omega \cap D$, the equilibrium is asymptotically stable for the closed loop with a region attraction (of at least) D .*

We refer to De Leenheer and Aeyels (2002) for a full proof, here we only briefly mention that local asymptotic stability follows (almost) directly from the theory of semidefinite Lyapunov functions, see e.g. Chabour and Kalitine (2002, Theorem 2). However, to prove more than a non-trivial region of attraction, the argument of Lemma 1 in De Leenheer and Aeyels (2002) must be used. Theorem 6.1 together with Lemma 1 in De Leenheer and Aeyels (2002) proves that the equilibrium is attractive for initial conditions in D , and together with the stability from the semidefinite Lyapunov function (see e.g. Chabour and Kalitine (2002, Theorem 1), or Iggidr et al. (1996, Theorem 1)), this implies asymptotic stability.

Since the closed loop on Ω has a first integral in each phase given by $M_j(x) = \sum_{i=1}^{r_j} z_i^j = M_j^*$, one state of each phase can be determined by the other states of that phase. Therefore, the dynamics on Ω can be represented by a lower dimensional system, which might make the analysis easier. Let the dynamics on Ω be parameterized by

$$\dot{y} = g(y), \quad y \in \Gamma \quad (6.9)$$

where $\Gamma \subset \mathbb{R}_+^{n-m}$ is compact, and assume $g \in C^1$. As discussed above, if g has an asymptotically stable equilibrium, then so does the closed loop system itself. See also Chabour and Kalitine (2002, Section 5.1). If in addition this is the single equilibrium on Γ and and this equilibrium is attractive for all $y \in \Gamma$, then Theorem 6.2 can be used.

In the case the dynamics on Ω can be parameterized by a two-dimensional ODE ($\dim(y) = 2$), there exists some criteria for ruling out or establish the existence of periodic orbits. The following sufficient result is cited from Perko (1996):

$B \sin(\sqrt{2t+C})$, $z(t) = \frac{1}{\sqrt{2t+C}}$ where A, B and C are positive constants given by the initial conditions. The trajectories converge to circles in the plane $z = 0$, with fixed radius $\sqrt{A^2 + B^2}$.

Lemma 6.1 (Dulac's Criterion) *Consider (6.9), and let Γ be a simply connected region in \mathbb{R}^2 . If there exists a function $B : \mathbb{R}^2 \rightarrow \mathbb{R}$, $B \in C^1$, such that $\nabla(Bg)$ is not identically zero and does not change sign in Γ , then (6.9) has no closed orbit lying entirely in Γ .*

This is proved using Green's Theorem. The case with $B = [1 \ 1]$ gives Bendixson's Criterion, which amounts to checking the sign of the divergence $\partial g_1/\partial y_1 + \partial g_2/\partial y_2$ of the vector field g .

The Poincaré-Bendixson Theorem (Perko, 1996) is a tool for telling if there *is* a periodic orbit on Ω . More suitable for our purpose, we cite the corollary in Khalil (2002):

Lemma 6.2 (Poincaré-Bendixson's Criterion) *Consider (6.9) and let Γ be a closed bounded subset of the plane such that*

- Γ contains no equilibrium points, or contains only one equilibrium point such that the Jacobian at this point has eigenvalues with positive real parts.
- Every trajectory starting in Γ stays in Γ for all future time.

Then Γ contains a periodic orbit of (6.9).

The (generalized) Poincaré-Bendixson Theorem also tells us that in the two-dimensional case, the only possibilities for trajectories confined to a compact set, is convergence to an equilibrium, a periodic orbit or a graphic (a compound separatrix cycle).

Since a graphic never appears in practice, if Lemma 6.1 is used to rule out a periodic orbit on the whole of Ω , then “globally” (relative to Ω) attractive equilibria are the only possibility. If there is only one equilibrium that in addition is stable, we can conclude closed loop asymptotic stability by Theorem 6.2. On the other hand, Lemma 6.2 can only be used as an *indication* that there might be closed loop periodic orbits.

In the case that $\dim(y) = 1$, the following simple lemma can imply closed loop asymptotic stability by Theorem 6.2:

Lemma 6.3 *If $g(y_s) = 0$ for some y_s in the interior of Γ , and $(y - y_s)g(y) < 0$ for $y \neq y_s$, then y_s is an asymptotically stable equilibrium with region of attraction Γ .*

This follows directly from Lyapunov theory (take as Lyapunov function $(y - y_s)^2$). Note that (for instance) $g(y)$ strictly decreasing everywhere in Γ (or monotonically everywhere, strictly at $y = y_s$) implies $(y - y_s)g(y) < 0$ for $y \neq y_s$.

Assume now that the system trajectories *do* converge to an (asymptotically stable) equilibrium in Ω . Then, at this equilibrium, u_j will have a constant value, a steady state control input u_j^* . In many applications, the intersection of the system equilibria (parameterized by u_j) and the set Ω is a singleton. In this case, one can use the M_j^* s to choose the desired equilibrium.

6.4.2 Robustness

The proposed feedback scheme is independent of the interconnection structure and hence robust⁴ to model uncertainties in $\Phi(x)$ (as long as Assumption A1 holds). As mentioned in Bastin and Praly (1999), the interconnection terms are in practical examples often the terms that are hardest to model.

However, the unconstrained controller also has robustness-properties with respect to bounded uncertainties in $\Psi(x)$ and $B(x)$.

Assume in the following that the input saturations are not met, that is, $u_j(x) = \tilde{u}_j(x)$. In the nominal case, the feedback (6.3) then linearizes the dynamics of the mass of phase j ,

$$\dot{M}_j(x) = \lambda_j (M_j^* - M_j(x)). \quad (6.10)$$

Assume further that the modeling errors in $\Psi(x)$ and $B(x)$ are bounded. Mark the “real” values of the terms involved in the controller (6.3) with a tilde, and assume that there exists norm-bounded $\Delta_j^\psi = \Delta_j^\psi(x, t)$ and $\Delta_j^b = \Delta_j^b(x, t)$ (the dependence on x and t is sometimes suppressed for notational simplicity in the following) such that the nominal values (used in the controller) are related to the real values as

$$\sum_{i=1}^{r_j} \tilde{\psi}_j^i(x) = \sum_{i=1}^{r_j} \psi_j^i(x) + \Delta_j^\psi, \quad \sum_{i=1}^{r_j} \tilde{b}_j^i(x) = (1 + \Delta_j^b) \sum_{i=1}^{r_j} b_j^i(x).$$

⁴Robust in the sense that convergence to Ω still holds. Note that changes in $\Phi(x)$ will typically move the equilibria on Ω .

The real dynamics of phase j can then be written

$$\begin{aligned}
 \dot{M}_j(x) &= \sum_{i=1}^{r_j} \tilde{\psi}_j^i(x) + \sum_{i=1}^{r_j} \tilde{b}_j^i(x) u_j(x) \\
 &= \sum_{i=1}^{r_j} \psi_j^i(x) + \Delta_j^\psi \\
 &\quad + (1 + \Delta_j^b) \sum_{i=1}^{r_j} b_j^i(x) \frac{1}{\sum_{i=1}^{r_j} b_j^i(x)} \left(- \sum_{i=1}^{r_j} \psi_j^i(x) + \lambda_j (M_j^* - M_j(x)) \right) \\
 &= \lambda_j (M_j^* - M_j(x)) + \Delta_j^\psi + \Delta_j^b \left(- \sum_{i=1}^{r_j} \psi_j^i(x) + \lambda_j (M_j^* - M_j(x)) \right)
 \end{aligned}$$

The last part is in general not bounded in terms of x . However, we assume that we can define

$$\delta_j(t) = \Delta_j^\psi(x(t), t) + \Delta_j^b(x(t), t) \left(- \sum_{i=1}^{r_j} \psi_j^i(x(t)) + \lambda_j (M_j^* - M_j(x(t))) \right)$$

such that $\delta_j(t)$ is norm-bounded, $\delta_j(t) \leq \bar{\delta}_j$. This requires either that $\Delta_j^b(x(t), t) \equiv 0$, or that we know that $x(t)$ is bounded (which is guaranteed by initial conditions in a bounded, invariant set).

The mass dynamics can under the above assumptions be written

$$\dot{M}_j(x(t)) = -\lambda_j (M_j(x(t)) - M_j^*) + \delta_j(t). \quad (6.11)$$

Since this is linear, it is easy to solve this to find

$$M_j(x(t)) = M_j^* + e^{-\lambda_j(t-t_0)} (M_j(x(t_0)) - M_j^*) + \int_{t_0}^t e^{-\lambda_j(t-\tau)} \delta_j(\tau) d\tau$$

where the last element is bounded,

$$\left| \int_{t_0}^t e^{-\lambda_j(t-\tau)} \delta_j(\tau) d\tau \right| \leq \frac{1 - e^{-\lambda_j(t-t_0)}}{\lambda_j} \bar{\delta}_j \leq \frac{\bar{\delta}_j}{\lambda_j}.$$

We see that $M_j(x(t))$ converges to the set $\{M_j \mid |M_j - M_j^*| \leq \frac{\bar{\delta}_j}{\lambda_j}\}$ which can be made arbitrarily close to M_j^* by choosing λ_j large. Of course, in choosing λ_j large, the system might become more vulnerable to the influence of measurement noise and unmodeled dynamics.

The above analysis is only valid as long as the input is not saturated. What happens when the input is saturated can be (conservatively) analyzed by examining if the ‘‘Lyapunov function’’ of Theorem 6.1 is still decreasing under the allowed perturbations. This can be done by checking if assumptions similar to Assumption A3 hold for the perturbed flows.

6.4.3 Asymptotic stability of Ω

Theorem 6.1 does not guarantee stability (as is well known, convergence (attractivity) does not imply stability in general). However, $V(x)$ can be used as a Lyapunov function to show that the (compact) set Ω is (uniformly) asymptotically stable. Let $|x|_\Omega := \inf_{y \in \Omega} \|x - y\|$ be the distance from x to Ω , and assume for simplicity that $\Omega \subset D$ (the conclusions will hold for if we consider $\Omega \cap D$ as well). We know from the Theorem 6.1 that Ω is attractive (from some set containing Ω), and⁵ $\dot{V}(x) < 0$ in a neighborhood of Ω . If we can show that $V(x)$ is positive definite with respect to Ω (implied by $V(x) > k \cdot |x|_\Omega^2$ for some positive constant k), then Ω is locally stable. The fact (see e.g. Teel and Praly (2000, Proposition 3) for a general statement) that for *time-invariant* differential equations, uniform asymptotic stability of a *compact* set is equivalent to (uniform) local stability plus attractivity then gives us the desired conclusion.

It remains to show that $V(x)$ is positive definite with respect to Ω . For a given $x \neq \Omega$, let $y^*(x)$ denote the element in Ω closest to x , $y^*(x) := \arg \inf_{y \in \Omega} \|x - y\|$. For simplicity, we initially assume only one phase and let $a = [1, 1, \dots, 1]^\top$, such that $a^\top y^*(x) = M^*$. Then,

$$\begin{aligned} |a^\top(x - y^*(x))| &= \|a\| \cdot \|x - y^*(x)\| \cdot |\cos \theta| \\ &= \sqrt{n} \cdot |x|_\Omega \cdot |\cos \theta|. \end{aligned}$$

The typical case is $\theta = 0$ (or $\theta = \pi$), since the shortest distance is when $x - y^*(x)$ is perpendicular to the hyperplane $a^\top x = M^*$, which has a as normal.

Given an \tilde{x} in \mathbb{R}_+^n , not in Ω :

- If $a^\top \tilde{x} < M^*$, then it is always possible to make a line through \tilde{x} parallel to a that intercepts Ω . To see this, note that it is always possible to find a positive (scalar) γ such that⁶ $y = \tilde{x} + \gamma a \in \Omega$. Since the line is parallel to a , which is normal to Ω , the line is also normal to Ω , and hence the shortest distance between \tilde{x} and Ω is along this line. From $\tilde{x} - y = -\gamma a$, the angle $\theta = \pi$.

⁵Strictly speaking, we only proved $\dot{V}(x) \leq 0$ in the proof of Theorem 6.1. However, as long $\tilde{u}_j(x) > 0$ close to Ω (as Assumption 6.2 actually implies by a continuity argument), by the proof of Theorem 6.1 $\dot{V}(x) < 0$ close to Ω . Anyway, this is not important since by $\dot{V}(x) \leq 0$, the positive definiteness (to be shown) of $V(x)$ with respect to Ω together with the attractivity proved by LaSalle's invariance principle in Theorem 6.1 also implies asymptotic stability.

⁶By choosing $\gamma = \frac{M^* - a^\top \tilde{x}}{n}$, we see that $a^\top y = M^*$. Since γ is positive and $\tilde{x} \in \mathbb{R}_+^n$, then also $y \in \mathbb{R}_+^n$, which shows that $y \in \Omega$. Positive γ only holds if $a^\top \tilde{x} < M^*$. If $a^\top \tilde{x} > M^*$, we have to choose γ negative, and then y is not guaranteed to be positive, that is, y is not necessarily in Ω .

- If $a^\top \tilde{x} > M^*$, then it might happen that the point y on the hyperplane $a^\top x = M^*$ that makes $\tilde{x} - y$ parallel to a does not satisfy $y \in \Omega$. However, note that for $a^\top \tilde{x} > M^*$, all elements of $\tilde{x} - y^*(\tilde{x})$ is always positive⁷. Then the following inequality holds: $a^\top (\tilde{x} - y^*(\tilde{x})) = \sum (\tilde{x}_i - y_i^*(\tilde{x})) \geq \|\tilde{x} - y^*(\tilde{x})\|$ (by the relation between the 1-norm and 2-norm. Equality occurs when \tilde{x} is on an axis). The angle then satisfies

$$\cos \theta = \frac{a^\top (x - y^*(x))}{\|a\| \cdot \|x - y^*(x)\|} \geq \frac{1}{\sqrt{n}}.$$

This means that we can take $\theta \in \{\tilde{\theta} \mid \tilde{\theta} = \pi \text{ or } \cos \tilde{\theta} \geq \frac{1}{\sqrt{n}}\}$.

Since $a^\top (x - y^*(x)) = a^\top x - a^\top y^*(x) = M(x) - M^*$, we see that

$$V(x) = \frac{n}{2} \cdot |x|_\Omega^2 \cdot \cos^2 \theta,$$

or (since $\frac{1}{\sqrt{n}} \leq |\cos \theta| \leq 1$),

$$\frac{1}{2}|x|_\Omega^2 \leq V(x) \leq \frac{n}{2}|x|_\Omega^2. \quad (6.12)$$

In the case of more than one phase, the same argument shows that for each phase,

$$\frac{1}{2}|z^j|_{\Omega_j}^2 \leq \frac{1}{2}(M_j(x) - M_j^*)^2 \leq \frac{r_j}{2}|z^j|_{\Omega_j}^2$$

(where $\Omega_j := \{w \in \mathbb{R}_+^{r_j} \mid \sum_{i=1}^{r_j} w_i = M_j^*\}$), which, since

$$|x|_\Omega^2 = \inf_{y \in \Omega} \|x - y\|^2 = \sum_{j=1}^m \inf_{w^j \in \Omega_j} \|z^j - w^j\|^2 = \sum_{j=1}^m |z^j|_{\Omega_j}^2,$$

by summation implies that

$$\frac{1}{2}|x|_\Omega^2 \leq V(x) \leq \frac{\max_{j \in \{1, \dots, m\}} r_j}{2} |x|_\Omega^2. \quad (6.13)$$

6.5 Simple examples

In this section, the theory will be illuminated by some simple examples. In the next section, the example that inspired the development of the theory will be presented.

⁷As above, the closest point on $a^\top x = M^*$ can be written $y = \tilde{x} + \gamma a$, now with γ negative. If $y \in \Omega$, then the positivity of the elements of $\tilde{x} - y$ follows directly. If y is not in Ω , then $y^*(\tilde{x})$ is equal to y with the negative elements set to zero, hence the elements of $\tilde{x} - y^*(\tilde{x})$ are positive.

6.5.1 Tanks in series

Consider a system with three tanks in series,

$$\dot{x}_1 = u_1 - \alpha_1 \sqrt{x_1} \quad (6.14a)$$

$$\dot{x}_2 = \alpha_1 \sqrt{x_1} - \alpha_2 \sqrt{x_2} \quad (6.14b)$$

$$\dot{x}_3 = \alpha_2 \sqrt{x_2} - \alpha_3 \sqrt{x_3} u_2, \quad (6.14c)$$

where the states are the level (or mass, or pressure) in each tank. The inflow to the first tank and the outflow of the third tank can be controlled, and are bounded, $0 \leq u_i \leq \bar{u}_i$. The system is obviously positive. See Figure 6.3.

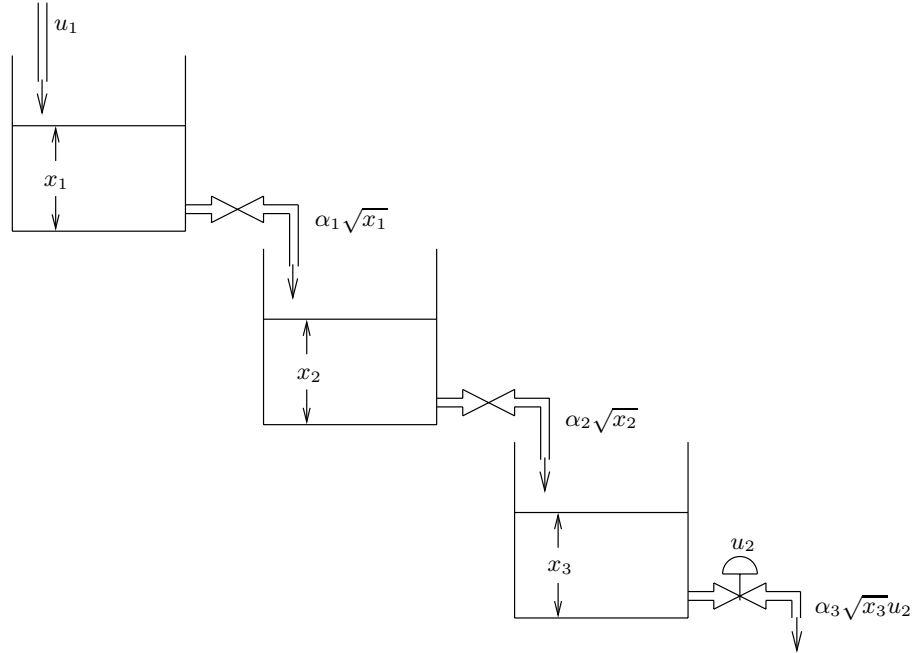

Figure 6.3: Tanks in series.

According to the assumptions in Section 6.2, there are several different control structures that can be chosen, depending on how we divide the state into phases, and which inputs we choose to control.

- i) Choosing u_1 as control, setting $u_2 = u_2^* > 0$ constant, and total mass $M(x) = x_1 + x_2 + x_3$ gives

$$\tilde{u}_1 = \alpha_3 \sqrt{x_3} u_2^* + \lambda_1 (M^* - M(x)). \quad (6.15)$$

The (single) phase is inflow controlled. Assumption A3.a.1 obviously holds globally, and Assumption A3.a.2 (which translates to $\alpha_3\sqrt{x_3}u_2^* < \bar{u}_1$ for $M(x) < M^*$) holds on \mathbb{R}_+^n if M^* is chosen such that $\alpha_3\sqrt{M^*}u_2^* < \bar{u}_1$. Then, by Corollary 6.1, the state converges to $\Omega = \{x \mid M(x) = M^*\}$ from any (positive) initial condition.

- ii) Choosing u_2 as control, setting $u_1 = u_1^* > 0$ constant, and total mass $M(x) = x_1 + x_2 + x_3$ gives

$$\tilde{u}_2 = \frac{-1}{\alpha_3\sqrt{x_3}} [-u_1^* + \lambda_2(M^* - M(x))]. \quad (6.16)$$

The single phase is outflow controlled. Assumption A3.b.1 holds globally, but Assumption A3.b.2 ($u_1^* < \alpha_3\sqrt{x_3}\bar{u}_2$ for $M(x) > M^*$) does not hold globally for any combination of M^* and \bar{u}_2 (consider e.g. an initial condition with $x_3(0) = 0$ and $M(x(0)) > M^*$).

Let $D_2 = \{x \in \mathbb{R}_+^3 \mid x_1 \geq a, x_2 \geq b, x_3 \geq c\}$ with a, b and c positive constants satisfying $a < \left(\frac{u_1^*}{\alpha_1}\right)^2$, $b < \left(\frac{\alpha_1}{\alpha_2}\right)^2 a$ and $c < \left(\frac{\alpha_2}{\alpha_3}\right)^2 b$. Assumption A3.b.2 hold on D_2 if \bar{u}_2 satisfies $u_1^* < \alpha_3\sqrt{c}\bar{u}_2$. Since D_2 satisfies Assumption 6.3, convergence to Ω (if the intersection between Ω and D_2 is nonempty) from initial conditions in D_2 follows from Corollary 6.3.

- iii) Phase 1 consist of x_1 and x_2 ($M_1(x) = x_1 + x_2$), phase 2 of x_3 ($M_2(x) = x_3$):

$$\tilde{u}_1 = \alpha_2\sqrt{x_2} + \lambda_1(M_1^* - M_1(x)), \quad (6.17a)$$

$$\tilde{u}_2 = \frac{-1}{\alpha_3\sqrt{x_3}} [-\alpha_2\sqrt{x_2} + \lambda_2(M_2^* - M_2(x))]. \quad (6.17b)$$

Phase 1 is inflow controlled. Assumption A3.a.1 holds, and Assumption A3.a.2 ($\alpha_2\sqrt{x_2} < \bar{u}_1$ for $M_1(x) < M_1^*$) holds globally if $\alpha_2\sqrt{M_1^*} < \bar{u}_1$. Phase 2 is outflow controlled. Assumption A3.b.1 holds globally, but Assumption A3.b.2 ($\alpha_2\sqrt{x_2} < \alpha_3\sqrt{x_3}\bar{u}_2$ for $M_2(x) > M_2^*$) does not hold globally. However, since $\alpha_2\sqrt{x_2} < \alpha_3\sqrt{x_3}\bar{u}_2$ for $M_2(x) > M_2^*$ holds when $x_2 < \left(\frac{\alpha_3}{\alpha_2}\right)^2 M_2^*\bar{u}_2$, we can have $D_1 = \{x \in \mathbb{R}_+^3 \mid 0 \leq x_1 + x_2 \leq \left(\frac{\alpha_3}{\alpha_2}\right)^2 M_2^*\bar{u}_2\}$ (obviously, with $M_1^* < \left(\frac{\alpha_3}{\alpha_2}\right)^2 M_2^*\bar{u}_2$) and convergence to Ω is guaranteed from initial conditions in D_1 from Corollary 6.2.

iv) Phase 1 consist of x_1 ($M_1(x) = x_1$), phase 2 of x_2 and x_3 ($M_2(x) = x_2 + x_3$):

$$\tilde{u}_1 = \alpha_1 \sqrt{x_1} + \lambda_1 (M_1^* - M_1(x)), \quad (6.18a)$$

$$\tilde{u}_2 = \frac{-1}{\alpha_3 \sqrt{x_3}} [-\alpha_1 \sqrt{x_1} + \lambda_2 (M_2^* - M_2(x))]. \quad (6.18b)$$

Phase 1 is inflow controlled. Assumption A3.a.1 holds globally, and Assumption A3.a.2 ($\alpha_1 \sqrt{x_1} < \bar{u}_1$ for $M_1(x) < M_1^*$) holds if $\alpha_1 \sqrt{M_1^*} < \bar{u}_1$. Phase 2 is outflow controlled. Assumption A3.b.1 holds globally, but Assumption A3.b.2 ($\alpha_1 \sqrt{x_1} < \alpha_3 \sqrt{x_3} \bar{u}_2$ for $M_2(x) > M_2^*$) does not hold globally.

Suppose we specify that initial conditions for x_1 should satisfy $\underline{c}_1 \leq x_1 (= M_1(x)) \leq \bar{c}_1$. Similarly as in ii), there exists b and c such that $D_2 = \{\underline{c}_1 \leq x_1 (= M_1(x)) \leq \bar{c}_1, x_2 \geq b, x_2 \geq c\}$ is (closed loop) invariant. Suppose that $\alpha_1 \sqrt{\bar{c}_1} < \alpha_3 \sqrt{\bar{c}_1} \bar{u}_2$ holds, then Corollary 6.3 guarantees convergence to Ω from initial conditions in D_2 .

Simulations indicate that the regions of attractions given in iii) and iv) are rather conservative. The reasons for this (as discussed in Section 6.3.3), is that Theorem 6.1 requires the time derivatives of $V_j(x)$ to be negative at all times. In both cases, if there is a large amount of mass in the first phase compared to the second phase, due to the saturation of the outflow, it is impossible to avoid the situation where the mass in the second phase increases. However, since the inflow to the first phase is also restricted, after a while the mass is distributed such that the masses in both phases decrease.

Let us analyze the dynamics on Ω in i) above (when the input $u_1 = \alpha_3 \sqrt{x_3} u_2^*$). First, note that there is a unique equilibrium on Ω . The dynamics on Ω can be parameterized by x_1 and x_2 , with $x_3 = M^* - x_1 - x_2$:

$$\dot{x}_1 = \alpha_3 \sqrt{M^* - x_1 - x_2} u_2^* - \alpha_1 \sqrt{x_1} =: f_1(x) \quad (6.19a)$$

$$\dot{x}_2 = \alpha_1 \sqrt{x_1} - \alpha_2 \sqrt{x_2} =: f_2(x). \quad (6.19b)$$

We have that

$$\frac{\partial f_1}{\partial x_1} + \frac{\partial f_2}{\partial x_2} = -\frac{\alpha_3 u_2^*}{2\sqrt{M^* - x_1 - x_2}} - \frac{\alpha_1}{2\sqrt{x_1}} - \frac{\alpha_2}{2\sqrt{x_2}} \quad (6.20)$$

has the same sign for all x_1, x_2 such that $M^* - x_1 - x_2 > 0$ (that is, on Ω). Then, we conclude by Bendixon's Criterion (Lemma 6.1) that no periodic orbits can exist in Ω . From this and the discussion in Section 6.4.1, we conclude that all trajectories that enter Ω converge to the (unique) stable equilibrium on Ω .

The same analysis holds for case ii) above.

In case iii) (and case iv)), the dynamics on Ω can be parameterized by $\dot{x}_2 = \alpha_1 \sqrt{M_1^* - x_2} - \alpha_2 \sqrt{x_2}$ ($\dot{x}_2 = \alpha_1 \sqrt{M_1^*} - \alpha_2 \sqrt{x_2}$) with unique equilibrium $x_2 = \alpha_1^2 M_1^* / (\alpha_1^2 + \alpha_2^2)$ ($x_2 = M_1^* \alpha_1^2 / \alpha_2^2$). In both cases, \dot{x}_2 is strictly decreasing in x_2 , and Lemma 6.3 applies.

6.5.2 Food-chain systems

Consider the food-chain system (normalized second order prey-predator system with Lotka-Volterra predation mechanism, see Ortega, Astolfi, Bastin and Rodriguez-Cortes (1999))

$$\begin{aligned}\dot{x}_1 &= x_1 x_2 - x_1 \\ \dot{x}_2 &= -x_1 x_2 - x_2 + u,\end{aligned}$$

where the positive input $u \geq 0$ corresponds to creation of preys. This system is clearly positive, and fits in the considered model class. Since any equilibrium corresponding to a constant input is globally asymptotically stable, the control objective is (as in Ortega et al. (1999)) to stabilize the system at an equilibrium with a prespecified amount of ‘‘predators’’ $\bar{x}_1 = x_1^*$. The amount of preys will be $\bar{x}_2 = 1$.

Defining $M^* = x_1^* + 1$, the (unconstrained) state feedback controller becomes

$$u = \max\{0, x_1 + x_2 + \lambda(M^* - x_1 - x_2)\}.$$

where λ specifies how fast the total mass converges (which notably is *not* the speed of the convergence of x_1). At Ω , the dynamics is parameterized by $\dot{x}_1 = x_1(x_1^* - x_1 + 1) - x_1$. The Lyapunov function $V(x) = x_1 - x_1^* \ln x_1$ satisfies $\dot{V} = -(x_1 - x_1^*)^2$, showing that the equilibrium on Ω is globally asymptotically stable.

As in Ortega et al. (1999), the approach can be generalized to general food-chain systems of the form

$$\begin{aligned}\dot{x}_1 &= x_1 x_2 - x_1 \\ \dot{x}_2 &= -x_1 x_2 + x_2 x_3 - x_2 \\ \dot{x}_3 &= -x_2 x_3 + x_3 x_4 - x_3 \\ &\vdots \\ \dot{x}_n &= -x_{(n-1)} x_n - x_n + u\end{aligned}$$

where again the objective is to stabilize an equilibrium with a desired x_1^* . Defining $M^* = \frac{n}{2} x_1^* + n$ for n even, and $M^* = \frac{n+1}{2} x_1^* + n - 1$ for n odd, the

(still unconstrained) controller

$$u = \max\left\{0, \sum_{i=1}^n x_i + \lambda(M^* - \sum_{i=1}^n x_i)\right\} = \max\left\{0, (1 - \lambda) \sum_{i=1}^n x_i + \lambda M^*\right\} \quad (6.21)$$

achieves this. The unique (in the interior of \mathbb{R}_+^n) equilibrium is given by $\bar{x} = [x_1^*, 1, x_1^* + 1, 2, x_1^* + 2, \dots]$ where the i th element is given by $\bar{x}_i = \frac{i}{2}$ for i even, and $\bar{x}_i = x_1^* + \frac{i-1}{2}$ for i odd⁸.

Analyzing the dynamics on Ω did not succeed in general. The classical Lyapunov function for Lotka-Volterra ecologies, $V(x) = c_i(\sum x_i - \bar{x}_i \ln x_i)$, does not work for the dynamics on Ω for $n > 3$.

Choosing $\lambda > 1$, the total mass will converge before the states converge to their equilibrium values. Choosing $\lambda = 1$ corresponds to a constant input. Figure 6.4 shows a simulation of a 4th order food-chain system with the controller parameters $\lambda = .5$ and $x_1^* = 5$.

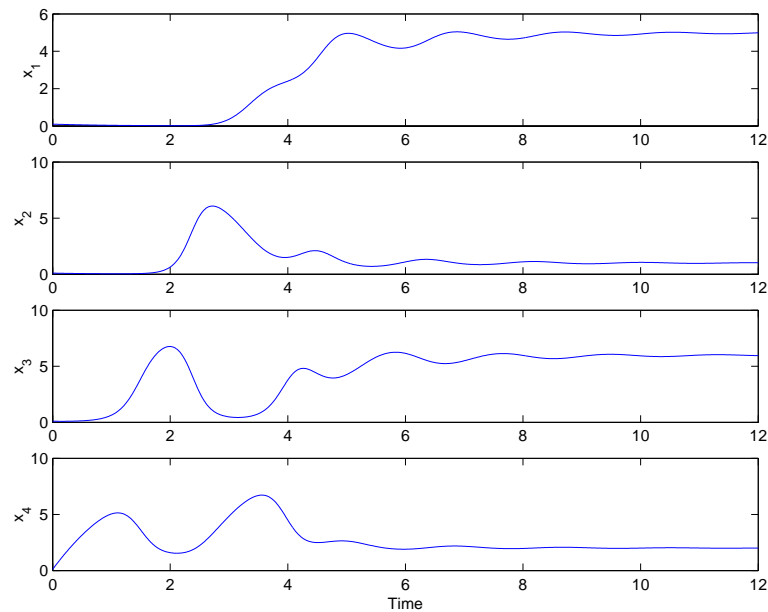

Figure 6.4: The state trajectory of 4th order predator-prey system with $\lambda = .5$ and $x_1^* = 5$.

⁸We see that the choice of M^* in this example only influences on the equilibrium values of x_i for i odd.

The total mass and the input is shown in Figure 6.5, where it is compared with the controller of Ortega et al. (1999). The approach taken herein is a state-feedback approach (except in the case $\lambda = 1$), while the controller in Ortega et al. (1999) is an output feedback approach ($u = x_1^* x_4 + 3$), so comparing the two approaches is not entirely fair. However, Figure 6.5 shows that the total mass controller converges faster with less control effort.

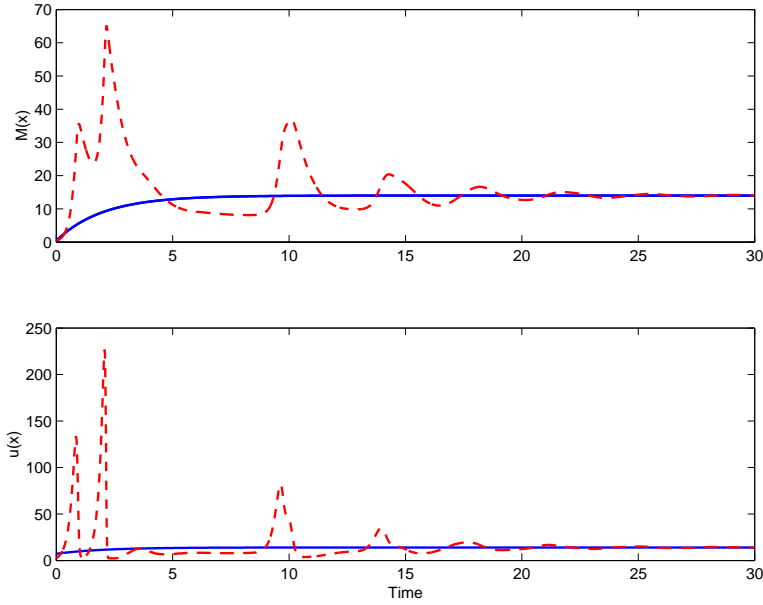

Figure 6.5: The total mass and the input, compared with the output feedback controller of Ortega et al. (1999) (dotted).

6.5.3 System with limit cycle

As an illustration of that (global) convergence to Ω does not imply convergence to an equilibrium, consider the following system, slightly different from an example in Maeda, Kodama and Ohta (1978) (see also Jacquez and Simon (1993)):

$$\dot{x}_1 = -x_1 + 3x_2 - x_3 + u \quad (6.22a)$$

$$\dot{x}_2 = x_1 - ((x_2 - 6)^2 + 5)x_2 - 3x_2 + 2x_3 \quad (6.22b)$$

$$\dot{x}_3 = ((x_2 - 6)^2 + 5)x_2 - 2x_3. \quad (6.22c)$$

The system has one phase, and we take $\bar{u} = 50$ and $M^* = 34$. The conditions of Corollary 6.1 is fulfilled, which means the system converges to $\Omega = \{x \in$

$\mathbb{R}_+^3 \mid M(x) = M^*$ from any positive initial condition, with the control (6.2) with $\tilde{u} = x_3 + \lambda(M^* - x_1 + x_2 + x_3)$.

Since the constraints are not met on Ω , $u = x_3$ on Ω^9 . The system dynamics (6.22) on Ω can be parameterized by x_1 and x_2 by substituting $x_3 = M^* - x_1 - x_2 = 34 - x_1 - x_2$,

$$\dot{x}_1 = -x_1 + 3x_2 \quad (6.23a)$$

$$\dot{x}_2 = -x_1 - ((x_2 - 6)^2 + 10)x_2 + 68. \quad (6.23b)$$

The Jacobian of (6.23) at the single (real) equilibrium (12, 4),

$$A = \begin{bmatrix} -1 & 3 \\ -1 & 2 \end{bmatrix}$$

has eigenvalues $\frac{1 \pm \sqrt{3}}{2}$, that is, the equilibrium is unstable.

By Theorem 6.1, the positive limit set of (6.22) is in Ω . Since there is no asymptotically stable equilibrium on Ω , the positive limit set cannot be an equilibrium.

Let us analyze the dynamics on Ω , where the dynamics is represented by (6.23). Since Ω is bounded, the states stay bounded on Ω . If the trajectory did not start in the unstable equilibrium at (12, 4), the trajectory will stay away from (12, 4). By Lemma 6.2 the system (6.23) has a periodic orbit in Ω . This is an indication (but no proof) that the closed loop system also has a periodic orbit, which is confirmed by simulations.

A state trajectory illustrating this is shown in Figure 6.6. The periodic orbit is a limit cycle.

6.5.4 Van der Vusse reactor

We consider the van der Vusse reaction kinetic scheme

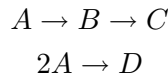

taking place in an isothermal CSTR. We consider two cases: First we assume perfect temperature control, and control the inflow rate of the reactant A based on the mass balance. The setup is taken from Doyle, Ogunnaike and Pearson (1995). Thereafter, we consider a model consisting of both mass balance and energy balance (the two phases) taken from Chen, Kremling and Allgöwer (1995), and control heat removal in addition to inflow rate.

⁹From this it is seen that on Ω , u cancels the “dissipative” element $-x_3$, giving the same dynamics as the original example in Maeda et al. (1978).

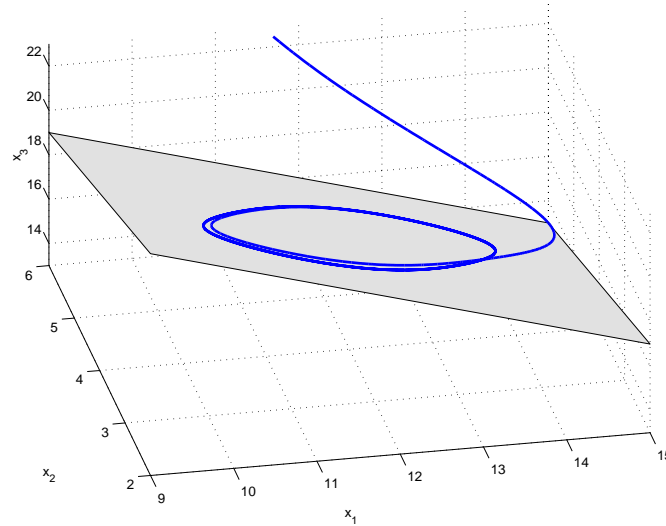
Figure 6.6: A state trajectory and (a part of) the set Ω .

Mass balance

A mass balance for components A and B (on a concentration basis) are given by

$$\dot{c}_A = -k_1 c_A - k_3 c_A^2 + u(c_{Af} - c_A) \quad (6.24a)$$

$$\dot{c}_B = k_1 c_A - k_2 c_B - u c_B \quad (6.24b)$$

where the involved constants are given in Table 6.1. The purpose of the controller is to regulate the concentration of component B (the product) by manipulating the inlet flow rate. An interesting property of the above equations, is that the reactor exhibits a change in gain at the maximum conversion level, and displays non-minimum phase behavior for operation to the left of this peak. This makes traditional PI control for this reactor impossible at this operating point.

k_1	50 h^{-1}
k_2	100 h^{-1}
k_3	$10 \text{ l mol}^{-1} \text{ h}^{-1}$
c_{Af}	10 mol l^{-1}

Table 6.1: Kinetic parameters, taken from Doyle et al. (1995)

The desired operating point in Doyle et al. (1995) is $c_A^* = 3.0$ and $c_B^* = 1.12$ (given by steady state input $u^* = 34.3$). This gives $M^* = 4.12$. We take $\bar{u} = 250$.

For this system, we note that Assumption A2 holds for $c_A + c_B \leq c_{Af}$. Assumption A3.a.1 holds, and Assumption A3.a.2, $k_3c_A^2 + k_2c_B < \frac{\bar{u}}{V}(c_{Af} - c_A - c_B)$, holds for $c_A + c_B \leq 7$ (at least). Consequently, we conclude by Corollary 6.2 that for initial conditions satisfying $0 \leq c_A + c_B \leq 7$, the controller given by

$$\tilde{u} = \frac{V}{c_{Af} - c_A - c_B} (k_3c_A^2 + k_2c_B + \lambda(M^* - M)) \quad (6.25)$$

makes the state converge to $c_A + c_B = M^*$. Figure 6.7 shows a simulation with $\lambda = 100$, where the setpoint of c_B is changed to 1.2 ($M^* = 6.74$) after $1h$. A higher value of λ makes the response faster, but increases the non-minimum phase phenomena (inverse response).

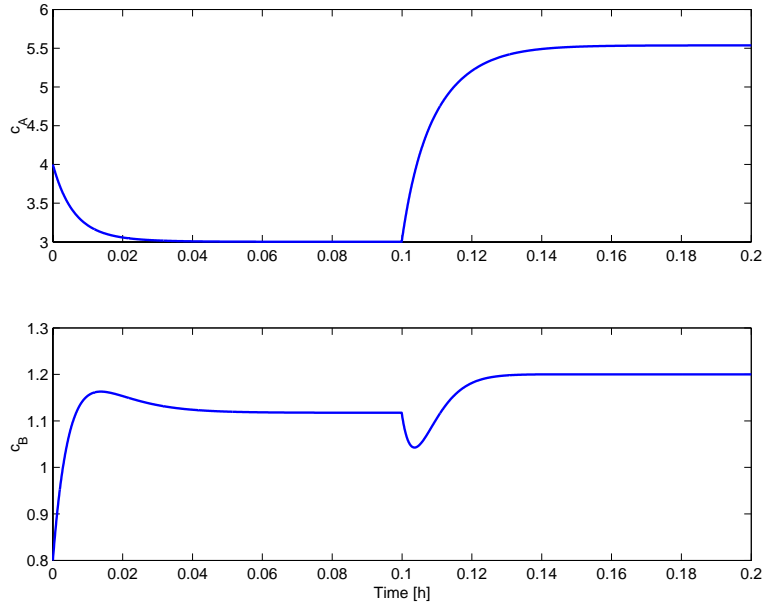

Figure 6.7: Simulation of van der Vusse reactor, with setpoint change in c_B after $.1h$.

The dynamics on Ω can be characterized by c_A ,

$$\dot{c}_A = -k_1c_A - k_3c_A^2 + \frac{c_{Af} - c_A}{c_{Af} - M^*} (k_3c_A^2 + k_2(M^* - c_A)). \quad (6.26)$$

Since $\dot{c}_A|_{c_A=0} > 0$, $\dot{c}_A|_{c_A=7} < 0$ and $\frac{d\dot{c}_A}{dc_A} < 0$ for $0 \leq c_A \leq 7$, the only equilibrium on Ω is asymptotically stable with respect to initial conditions in Ω by Lemma 6.3. By Theorem 6.2, the equilibrium is asymptotically stable and attractive for initial conditions in $0 \leq c_A + c_B \leq 7$. Calculations show that this equilibrium ($\dot{c}_A = 0$) is at $c_A = 3.0$, giving $c_B = M^* - c_A = 1.12$. We see that the choice of M^* decides the equilibrium.

The above analysis is made under the assumption that the system dynamics is perfectly known. If some of the “real” parameters (k_i) are different from the nominal ones, the equilibrium will be different than the desired one. This is also true for k_1 , however in this case the system will still converge to Ω . For (small enough) uncertainties in k_2 and k_3 , by Section 6.4.2, the distance to Ω after convergence can be specified by λ .

However, since the equilibrium can be decided in terms of M^* , it is possible to add ad hoc “integral control” to arrive at the desired density of c_B , by letting

$$\frac{d}{dt}M^* = -\mu(c_B - c_B^*), \quad (6.27)$$

for a “small” μ . We will not analyze this further. It should be noted that, as for “ordinary” PI control, this controller will not work at the point of optimal yield.

Mass and energy balance

The purpose of this section is to show that also models based on energy balances can be used. The energy balance describes the cooling that is caused by the cooling jacket. The states are the temperatures in the reactor, T and in the cooling jacket, T_K . Energy is removed from the cooling jacket by means of a heat exchanger. The rate of energy removal is the second input to the system. The mass and energy balance constitutes the two phases according to the setup in Section 6.2, the first phase being inflow controlled, the second outflow controlled. The model taken from Chen et al. (1995) is

$$\dot{c}_A = -k_1(T)c_A - k_3c_A(T)^2 + u_1(c_{Af} - c_A) \quad (6.28a)$$

$$\dot{c}_B = k_1(T)c_A - k_2(T)c_B - u_1c_B \quad (6.28b)$$

$$\dot{T} = u_1(T_0 - T) - \frac{1}{\rho C_p} \Delta E_R(x) + \frac{k_w A_R}{\rho C_p V_R} (T_K - T) \quad (6.28c)$$

$$\dot{T}_K = \frac{1}{m_K C_{PK}} (-u_2 + k_w A_R (T - T_K)), \quad (6.28d)$$

where

$$\Delta E_R(x) = k_1(T)c_A \Delta H_{RAB} + k_2(T)c_B \Delta H_{RBC} + k_3(T)c_A^2 \Delta H_{RAD} \quad (6.28e)$$

and the reaction kinetics are given from the Arrhenius law

$$k_i(T) = k_{i0}e^{E_i/T}, \quad i = 1, 2, 3. \quad (6.28f)$$

Nominal values of the physical and chemical parameters in the model (6.28) can be found in Chen et al. (1995).

Since the reactor and the cooling jacket have different heat capacities, the transfer of energy between the two leads to asymmetric temperature changes. This means that the energy transfer does not fulfill the interconnection assumption A1. This is avoided if we instead take as states the energies $\rho C_p V_R T$ and $m_K C_{PK} T_K$.

The control problem (from Chen et al. (1995)) is to stabilize the system at the working point $c_A = 2.14 \frac{\text{mol}}{l}$, $c_B = 1.09 \frac{\text{mol}}{l}$, $T = 387.2K$ and $T_K = 386.1K$. This is a more challenging control problem than in the previous section, since this working point is closer to the point of optimal yield. On the other side, we now have two degrees of freedom.

The input is then defined in terms of (6.2) and

$$\tilde{u}_1 = \frac{1}{c_{Af} - c_A - c_B} (k_3(T)c_A^2 + k_2(T)c_B + \lambda_1(M_1^* - M_1(x))) \quad (6.29a)$$

$$\tilde{u}_2 = u_1(T_0 - T)\rho C_p V_R - V_R \Delta E_R(x) - \lambda_2(M_2^* - M_2(x)), \quad (6.29b)$$

with saturations at $\bar{u}_1 = 35h^{-1}$ and $\bar{u}_2 = 9000 \frac{kJ}{h}$, and $M_2(x) = \rho C_p V_R T + m_K C_{PK} T_K$.

The ‘‘controllability properties’’ (related to Assumption A3) for the first phase is approximately the same as for the case when only mass the balance is considered. Assumption A3¹⁰ related to the second phase, holds only for a rather small operating range around the desired equilibrium. The reason for this is related to the exothermic nature of the reaction - for some initial conditions close to the desired equilibrium, the energy produced by the reaction is larger than the cooling jacket manages to take away, such that the total energy is increasing. A symptom of this, is that the energy production $\Delta E_R(x)$ changes very fast (exponentially) with the reactor temperature at this operating point. A remedy for getting a larger guaranteed region of attraction could be to choose another equilibrium, with lower temperatures. This could also be seen as choosing an operating point with better controllability. However, simulations indicate that the controller still works well even outside the region where the controllability assumptions for the second phase holds.

¹⁰Note that the input u_1 in (6.28c) is taken as a function of state while checking Assumption A3 for phase 2.

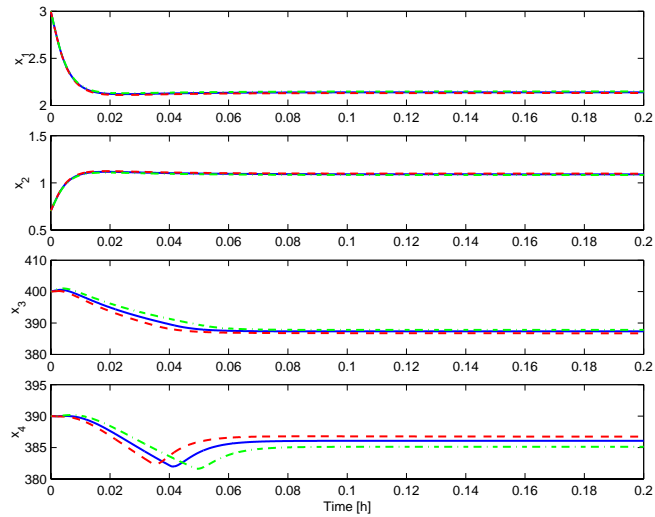

Figure 6.8: Simulation of Van der Vusse reactor showing the states, from initial condition $c_A = 3.0$, $c_B = .70$, $T = 400$ and $T_K = 390$. Nominal parameter set is shown with whole lines, set 1 is dashed, set 2 is dash-dotted.

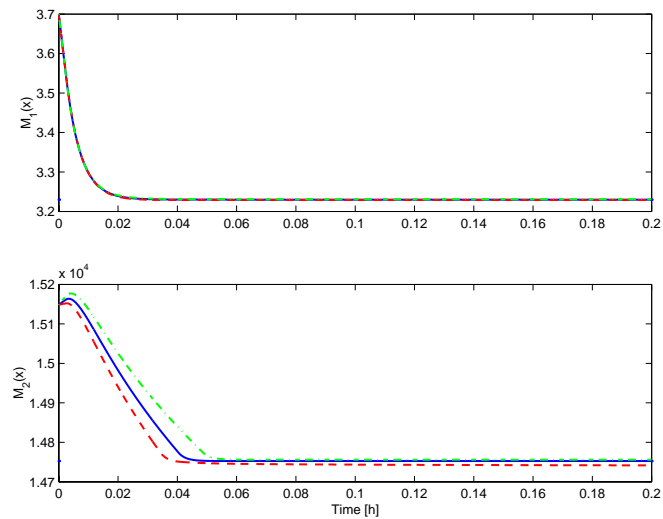

Figure 6.9: Simulation of Van der Vusse reactor showing the masses of the phases. Nominal parameter set is shown with whole lines, set 1 is dashed, set 2 is dash-dotted.

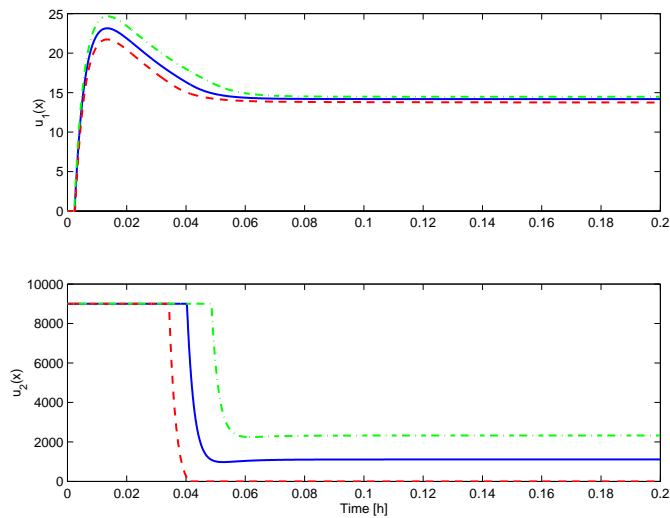

Figure 6.10: Simulation of Van der Vusse reactor showing the inputs. Nominal parameter set is shown with whole lines, set 1 is dashed, set 2 is dash-dotted.

The simulations in Figures 6.8-6.10 show that the controller is robust to the two “extreme” cases of parameter uncertainty taken from Chen et al. (1995) in the sense that stability and convergence to close to Ω is preserved. However the desired equilibrium is only approximately preserved. Note that for parameter set 2, the second input reaches its upper saturation at convergence, such that the theory does not really cover this case. Physically, the saturation says that heat removal is not necessary at this working point, for these parameters. Also the controller in Chen et al. (1995) saturates for this parameter set.

From that the “mass” of phase 2 is increasing initially (Figure 6.10), we see that the controllability assumptions A3 are not fulfilled for these initial conditions. The controller still works well.

6.6 Stabilization of flow in gas-lifted oil wells

6.6.1 Gas-lifted oil wells

The use of hydrocarbons is essential in modern every-day life. In nature, hydrocarbons are typically found in petroleum-bearing geological formations

(*reservoirs*) situated under the earth's crust, and to produce hydrocarbons from these reservoirs, one must often make an *oil well*.

An oil well is made by drilling a hole (wellbore) into the ground. A metal pipe (casing) is placed in the wellbore to secure the well, before "downhole well completion" is performed by running the production pipe (tubing), packing and possibly valves and sensors into the well and perforate the casing to make the reservoir fluid flow into the well. Detailed information on wells and well completion can e.g. be found in Golan and Whitson (1991), see also Figure 6.11.

If the reservoir pressure is high enough to overcome the back pressure from the flowing fluid column in the well and the surface (topside) facilities, the reservoir fluid can flow to the surface. In some cases, the reservoir pressure is not high enough to make the fluid flow freely, at least not at the desired rate. A remedy is then to insert gas close to the bottom of the well, which will mix with the reservoir fluid. See Figure 6.11, the gas is transported from the topside through the gas lift choke into the annulus (the space between the casing and the tubing), and enters the tubing through the injection valve close to the bottom of the well. The gas will help to "lift" the oil out of the tubing, through the production choke into the topside process equipment (separator).

This is the type of oil well we will consider herein. A problem with these type of wells, is that they can become (open loop) unstable, characterized by highly oscillatory well flow. The flow regime of the well (tubing) in this case is called *slug flow*. Slugging is undesirable since it lowers production and creates operational problems for downstream processing equipment.

If the instability is caused by dynamic interaction between the annulus and the tubing, this situation is called *casing heading*. The two main factors that induce casing heading, is high compressibility of gas in the annulus, and gravity dominated pressure drop in the two-phase flow in the tubing.

The reason for this instability can be outlined as follows: Consider an (open loop) situation where there is no (or low) flow in the tubing. The bottom hole pressure is high due to the weight of the fluid column in the tubing. Gas is inserted into the annulus, but because of the high bottom hole pressure, it does not enter the tubing initially. After a while, a sufficiently large amount of gas has been compressed in the annulus to overcome the bottom hole pressure, and gas starts to enter the tubing. This leads to higher production of the well, which reduces bottom hole pressure (since the pressure drop is gravity dominated), which makes more gas enter the tubing, leading to even higher production, and so on. This continues until there is no more gas (of sufficient pressure) in the annulus. Hence, no gas is injected into the tubing and the production decreases again to the well's

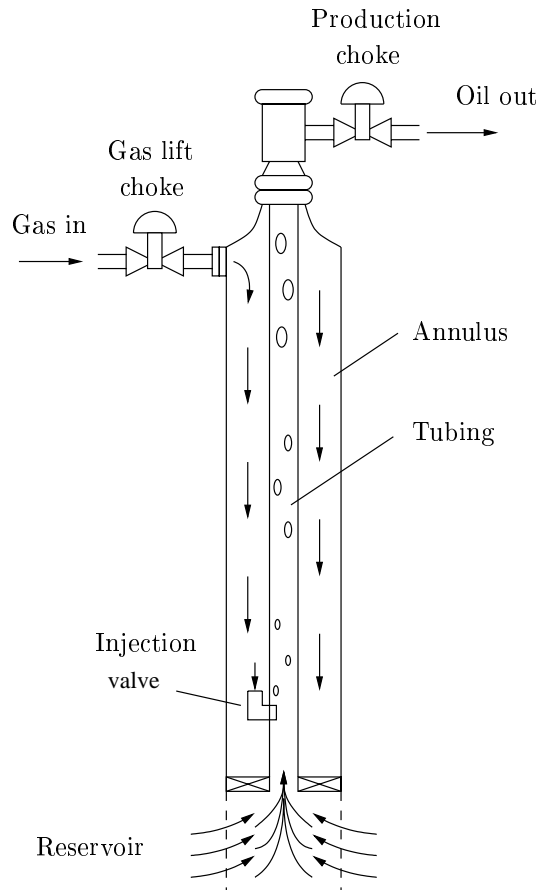

Figure 6.11: A gas-lifted oil well.

natural production (which might be zero). The cycle repeats itself.

The oil production for a typical oscillating well can be seen in Figure 6.12. Here, the behavior of the multiphase flow simulator OLGAs 2000 (Bendiksen, Malnes, Moe and Nuland, 1991, Scandpower, 2000) is compared to the behavior predicted by the simple model developed in Section 6.6.2 and Appendix B.

This problem is industrially important, as a considerable amount of such wells today are operated in an unstable condition. This (or similar) control problem is considered in e.g. Jansen, Dalsmo, Nøkleberg, Havre, Kristiansen and Lemetayer (1999), Eikrem, Foss, Imsland, Bin and Golan (2002). Both of these use PID controllers for stabilization.

Table 6.2 describes the parameters and the variables of the well we will

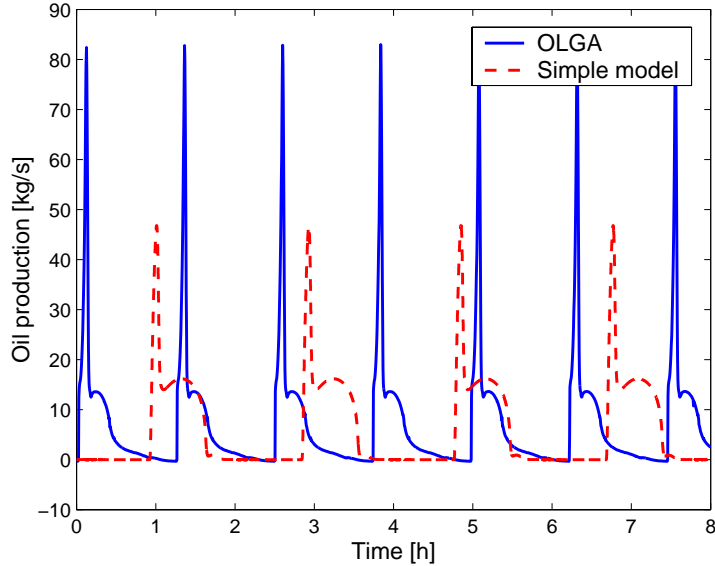

Figure 6.12: Comparison of open loop (gas lift choke is 50% open, production choke is 80% open) behavior between simple model and the rigorous multiphase flow simulator OLGA 2000.

use as a case study. For simplicity, we will assume that the reservoir contains only oil, which is a good approximation if the fraction of gas and water is low. However, the same procedure as taken herein can be taken for wells with higher gas production and watercut, assuming the amounts are (approximately) known. Further, we assume constant boundary conditions, that is, topside separator pressure, topside gas injection pressure and reservoir pressure (and well production index).

The chosen setup represents a realistic case. The purpose of the example, is to show that the well flow can be stabilized (become steady) using the production choke and the gas lift choke as control input. We will see that a mass balances model satisfying the assumptions of Section 6.2 will describe the dynamics of the well satisfactorily. In addition to simulations based on a simple mass balance model, also simulations using the rigorous multi-phase flow simulator OLGA are performed.

6.6.2 A model of a gas-lifted oil well

As discussed above, the mechanisms that makes the well produce in slugs, are related to the mass of gas in the annulus (compressibility) and the mass

6. TOTAL MASS CONTROLLER

Symbol	Explanation	Value	Unit
L_t	length of tubing	2048	m
D_t	diameter of tubing	.124	m
L_a	length of annulus	2048	m
D_a	(equivalent) diameter of annulus	0.2	m
L_r	length from reservoir to gas injection point	100	m
D_r	diameter of above	0.2	m
p_r	reservoir pressure	150e5	N/m
p_s	separator pressure	15e5	N/m
p_c	compressor pressure	130e5	N/m
M	molar weight of gas	0.0229	kg kmol ⁻¹
R	gas constant	8.314510/ M	kJ kg ⁻¹ K ⁻¹
f	friction factor	.003	
ρ_o	oil density (constant)	768.64	kg/m ³
ρ_c	gas density upstream (constant)	107.47	kg/m ³
T_a	temperature annulus	326	K
T_t	temperature tubing	394	K
C_r	production index	1.9992e-006	kg s ⁻¹ Pa ⁻¹
C_{gc}	Valve constant gal lift choke	8.86e-5	m ²
C_{iv}	Valve constant injection valve	2.14e-4	m ²
C_{pc}	Valve constant production choke	1.88e-5	m ²
C_c	Valve constant production choke	1.75e-1	s m ⁻¹

Table 6.2: Parameters in model of gas-lifted well

of fluid in the tubing (gravity). Consequently, it is reasonable to believe that an ODE based on mass balances will give a good description of the dynamic behaviour of the well,

$$\dot{x} = f(x, u), \quad (6.30)$$

where $x = [x_1, x_2, x_3]$ are the mass of gas in the annulus, mass of gas in tubing and mass of oil in tubing, respectively, and $u = [u_1, u_2]$ are the opening of the gas lift choke and the production choke.

As control volume, we take the tubing and the annulus. The in- and outflows (and flow between annulus and tubing) are given by the pressures on each side (the pressure difference) of the orifices, hence we need to be able to calculate these pressures as a function of the masses in the system. This is the main challenge of the modeling. Assume that these relations are

Symbol	Explanation	Unit
p_t	pressure top of tubing	N/m ²
p_{tb}	pressure bottom of tubing	N/m ²
p_a	pressure top of annulus	N/m ²
p_{ab}	pressure bottom of annulus	N/m ²
ρ_{gt}	gas density in top of tubing	kg/m ³
ρ_m	mixture density top of tubing	kg/m ³
ρ_{ab}	gas density bottom of annulus	kg/m ³
w_{iv}	gas flow from annulus into tubing	kg/s
w_{gc}	gas flow into annulus	kg/s
w_r	reservoir fluid (oil) flow into tubing	kg/s
w_{pg}	gas flow from tubing to separator	kg/s
w_{po}	oil flow from tubing to separator	kg/s
x_1 (m_a)	mass of gas annulus	kg
x_2 (m_{gt})	mass of gas tubing	kg
x_3 (m_{ot})	mass of oil tubing	kg
u_1	opening of gas lift choke	
u_2	opening of production choke	

Table 6.3: Variables in model of gas-lifted well

known:

$$\begin{aligned}
 p_t &= p_t(x, u) \\
 p_{tb} &= p_{tb}(x, u) \\
 p_a &= p_a(x, u) \\
 p_{ab} &= p_{ab}(x, u)
 \end{aligned}$$

An approach to find these relations is given in Appendix B. The relations found there are used in the simulations based on the mass balance model, and in (parts of) the analysis.

Based on simple valve characteristics (see e.g. Dvergsnes (1999)), the flows are assumed given as

$$\begin{aligned}
 w_{gc}(x) &= C_{gc} \sqrt{\rho_{ab} (p_{ab} - p_{tb})} \\
 w_{iv}(x, u_1) &= C_{iv} \sqrt{\rho_c (p_c - p_a)} u_1 \\
 w_r(x) &= C_r (p_r - p_{tb} - \rho_o g L_r) \\
 w_{pg}(x, u_2) &= \frac{m_{gt}}{m_{ot} + m_{gt}} C_{pc} \sqrt{\rho_m (p_t - p_s)} u_2 \\
 w_{po}(x, u_2) &= \frac{m_{ot}}{m_{ot} + m_{gt}} C_{pc} \sqrt{\rho_m (p_t - p_s)} u_2 C_c \frac{w_{pg}}{\rho_{gt} A_t}
 \end{aligned}$$

where the square root functions are defined to be zero for negative pressure differences. The ‘‘boundary conditions’’ p_r , p_s and p_c are assumed constant.

We will find p_a and p_{ab} (and ρ_{ab}) from the mass of gas in annulus as in Example B.1. In doing this we ignore the flow effects (acceleration and friction) in the annulus. An alternative could be to use the same approach as in Section B.2, taking the mass quality $x = 0$. Further, p_t and p_{tb} (and ρ_{gt} and ρ_m) are found from g_m and the mass of gas and oil in the tubing as in Section B.2.

This gives us the following mass balances describing the dynamics of the gas lifted well:

$$\begin{aligned}\dot{x}_1 &= -w_{gc}(x) + w_{iv}(x, u_1) && \text{mass of gas, annulus} \\ \dot{x}_2 &= w_{iv}(x) - w_{pg}(x, u_2) && \text{mass of gas, tubing} \\ \dot{x}_3 &= w_r(x) - w_{po}(x, u_2) && \text{mass of oil, tubing}\end{aligned}$$

6.6.3 State feedback control

The controlled flows fulfill Assumption A2 (considering Remark 6.2). However, as the expressions for the flows are rather inaccurate (especially for the multiphase flow through the production choke) we will assume that the flow of gas through the gas lift choke and the flow of oil through the production choke are measured, and that fast control loops control these measured variables. The setpoints for these loops will be the new manipulated variables. This will, in addition to being a more sensible engineering approach, simplify the equations. It also allows us to include rate saturations on the opening of the chokes in the simulations.

The dynamic model with the manipulated flows as controls, is

$$\dot{x}_1 = -w_{iv}(x) + v_1 \quad (6.31a)$$

$$\dot{x}_2 = w_{iv}(x) - w_{pg}(x, u_2(x)) \quad (6.31b)$$

$$\dot{x}_3 = w_r(x) - v_2 \quad (6.31c)$$

The upper saturations on both v_1 and v_2 (the maximum flows through the gas lift choke and the production choke) depends on the state (through the pressures). Noting that the maximum flows are always obtained when the chokes are maximally open, Assumption A3 can be checked for these saturations. These maximum flows will be referred to as $\bar{v}_1(x)$ and $\bar{v}_2(x)$, which are given by inserting $u_1 = u_2 = 1$ into the expressions for $w_{iv}(x, u_1)$ and $w_{po}(x, u_2)$.

Then, for $j \in \{1, 2\}$,

$$v_j(x) = \begin{cases} 0 & \text{if } \tilde{v}_j(x) < 0 \\ \tilde{v}_j(x) & \text{if } 0 \leq \tilde{v}_j(x) \leq \bar{v}_j(x) \\ \bar{v}_j(x) & \text{if } \tilde{v}_j(x) > \bar{v}_j(x) \end{cases} \quad (6.32)$$

where

$$\tilde{v}_1 = w_{pg}(x, u_2(x)) + \lambda_1(M_g^* - x_1 - x_2) \quad (6.33)$$

and

$$\tilde{v}_2 = w_r(x) - \lambda_2(M_o^* - x_3). \quad (6.34)$$

Remark 6.7 *If a mass transfer term $w_{og}(x)$ describing mass transfer between the phases (flashing) in the tubing is known, it can be included into the above setup by choosing*

$$\begin{aligned} \tilde{v}_1 &= w_{pg}(x, u_2(x)) - w_{og}(x) + \lambda_1(M_g^* - M(x)) \\ \tilde{v}_2 &= w_r(x) - w_{og}(x) - \lambda_2(M_o^* - x_3). \end{aligned}$$

According to Theorem 6.1, the behavior on the invariant set Ω could be a limit cycle where the distribution of the (constant) total mass of gas can oscillate. Considering the physics of the oil well, this situation is not very likely, since it is hard to imagine a situation where the mass of gas in the tubing can vary while the mass of oil stays constant. This intuition will be confirmed in the analysis below.

6.6.4 Analysis

We choose $M_g^* = 4400$ kg and $M_o^* = 4600$ kg.

For the gas phase (phase 1), Assumption A1 is fulfilled with $\phi_1^1(x) = -w_{iv}(x)$ and $\phi_2^1(x) = w_{gc}(x)$. The phase has controlled inflow, and Assumption A2 holds for $b^1(x) = [1, 0]^\top$. The “uncontrolled” external flow is $-w_{pg}(x, u_2(x))$. Assumption A3.a.1 obviously holds, while Assumption A3.a.2 needs more consideration.

The upper saturation of v_2 corresponds to the gas lift choke being fully opened, and the assumption can be written

$$w_{pg}(x, u_2(x)) < w_{iv}(x, 1), \quad \forall x \in D \cap \{x \mid x_1 + x_2 < 4400\}. \quad (6.35)$$

The oil phase (phase 2) has no interconnection terms, and Assumption A1 is trivially satisfied. The phase has controlled outflow, and Assumption A2 holds for $b^2(x) = -1$ if $0 \notin D$. The “uncontrolled” external flow is $-w_r(x)$. Assumption A3.b.1 holds as long as the tubing pressure $p_{tb} \leq \rho_o g L_r + p_r$, which can be translated into an upper limit on x_3 , the amount of oil in the tubing.

Assumption A3.b.2 can be written

$$w_r(x) < w_{po}(x, 1), \quad \forall x \in D \cap \{x \mid x_3 > 4600\}. \quad (6.36)$$

This means we have to find a set D that is invariant, and that for this set, the conditions (6.35) and (6.36) holds. By gridding and checking numerically, using the model in Appendix B, we find that

$$D = \{x \mid 3640 \leq x_1 \leq 4240, 510 \leq x_2 \leq 590, 4550 \leq x_3 \leq 4650\}$$

satisfies the demands. This D is not maximal in any way, most likely other choices of M_g^* and M_o^* , and other combinations of the upper and lower limits on the x_i can lead to considerably larger guaranteed region of attraction.

By Theorem 6.1, we know that $x_3 \rightarrow M_o^*$ and that $x_1 + x_2 \rightarrow M_g^*$, and that the set $\Omega = D \cap \{x \mid x_3 = M_o^* \text{ and } x_1 + x_2 = M_g^*\}$ is invariant. To analyze the dynamics on Ω , we parameterize the dynamics on Ω with x_2 ,

$$\dot{x}_2 = w_{gc}(x) - w_{pg}(x),$$

where $x_3 = M_o^*$ and $x_1 = M_g^* - x_2$ is substituted. Since $w_{gc}(x)$ decreases as the amount of gas in the tubing (x_2) increases, and $w_{pg}(x)$ increases, we conclude that \dot{x}_2 is decreasing in x_2 . See¹¹ Figure 6.13. We see that there is one equilibrium on Ω , and by Lemma 6.3 this is stable. We conclude that the closed loop system has one asymptotically stable equilibrium satisfying $x_1 + x_2 = M_g^*$ ($x_1 \approx 3852.7$ kg, $x_2 \approx 547.3$ kg) and $x_3 = M_o^*$, with region of attraction at least D .

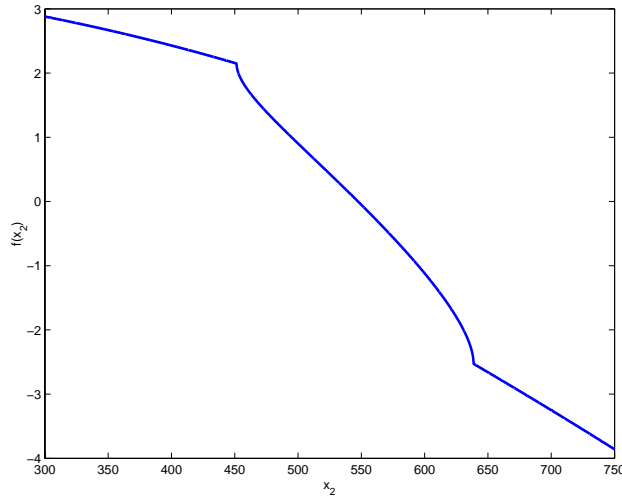

Figure 6.13: The scalar dynamics $\dot{x}_2 = f(x_2)$ on the invariant set.

¹¹The “kinks” in Figure 6.13 is due to the that the gas lift choke is a check valve, and that the production choke does not have counter-flow (is also a check valve).

6.6.5 Performance

Maximizing the performance of a gas-lifted well can be summarized as maximizing oil production w_{po} , keeping w_{iv} at an acceptable level (may be decided by topside production limitations).

In maximizing w_{po} we must also keep it stable, to maintain a high processing ability topside. Also, a stable flow gives higher production (Hu, Eikrem and Inslund, 2001), as illustrated in Figure 6.14.

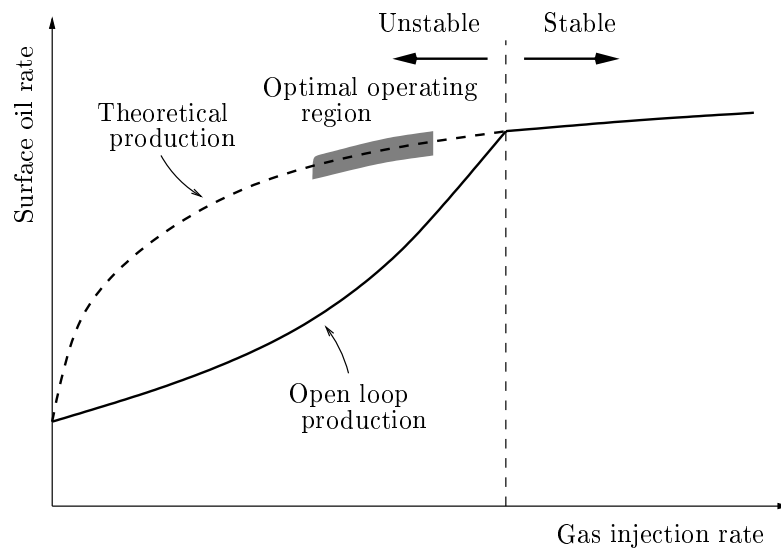

Figure 6.14: Oil production as a function of gas injection rate. The dotted line is production calculated by steady state simulations assuming stable operation. The solid line is generated by dynamic simulations.

Using the developed model (or a more sophisticated model), one can calculate M_g^* and M_o^* which maximizes oil production under the given constraints. These constraints must incorporate that the steady state flows should be feasible flows with respect to the choke saturations. Also, these flows should not correspond to saturated (fully opened) chokes. However, for most wells fully opened chokes will not be a optimal production condition. Keeping the desired operating point away from saturations will also give better controllability and robustness.

Simulations show that the real region of attraction is larger than the one found above, but not global. For instance, if the system is started in a “no production” state (tubing filled with oil), the system must be brought to a producing condition before the controller is turned on. This is due to the saturation of the chokes. If the tubing is filled with oil, the casing can be

filled with enough gas such that $x_1 + x_2 = M_g^*$, without gas being inserted into the tubing. The “oil controller” tries to decrease the amount of oil, but is non-successful since the well cannot produce oil with no gas inserted. Increasing M_g^* (temporarily) might be a solution.

6.6.6 State feedback simulation results using simple model

Using the model in Section 6.6.2, we simulated the closed loop. The controller used $M_g^* = 4400$ kg, $M_o^* = 4600$ kg and $\lambda_1 = \lambda_2 = .001$.

We included simple choke dynamics that consists of an integrator from commanded opening to real opening, with saturation and a 5 minutes time constant that should mimic rate saturation. The desired flow through the chokes are obtained by closing this loop with a P-controller. In the simulation, the controller is turned off after 3 hours, and turned on again after 8 hours. In Figure 6.15 we see that the equilibrium is unstable with constant inputs, but that the controller stabilizes the flow. Figure 6.16 shows the inputs. The choke movements are not excessive, and should be implementable by real chokes. Figure 6.17 shows the desired (calculated by the controller) flow and the “real” flow. Since these are rather similar, it shows that the fast inner control loops are working well, at a speed much faster than the dominating system dynamics.

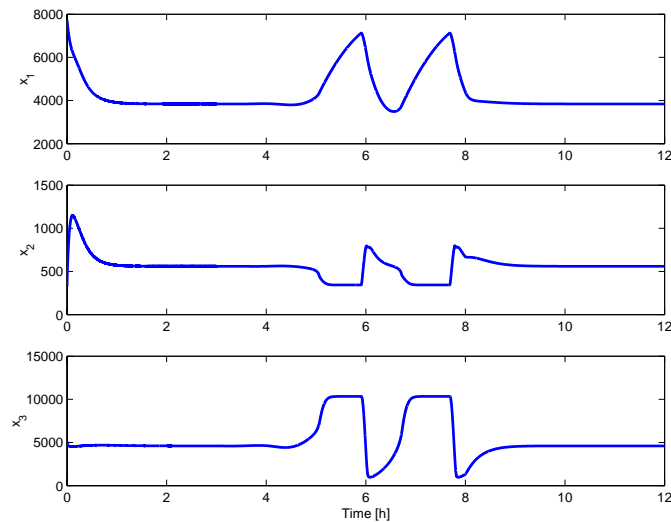

Figure 6.15: The states, simple model simulation

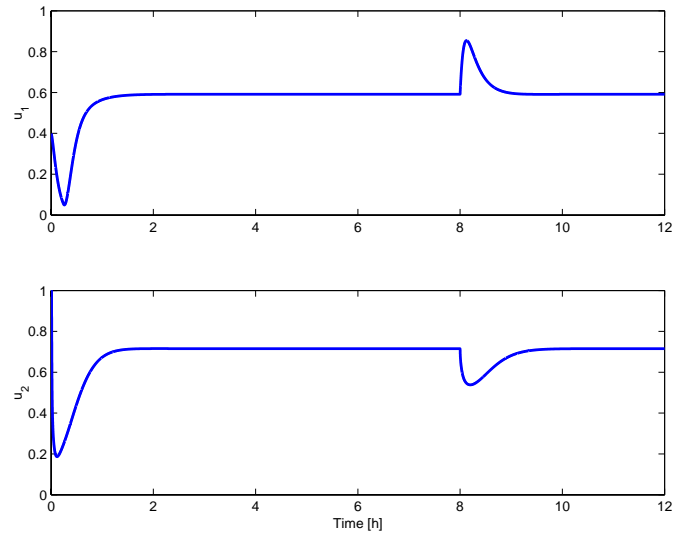

Figure 6.16: The inputs for simple model simulation. u_1 is the gas lift choke opening, u_2 is the production choke opening.

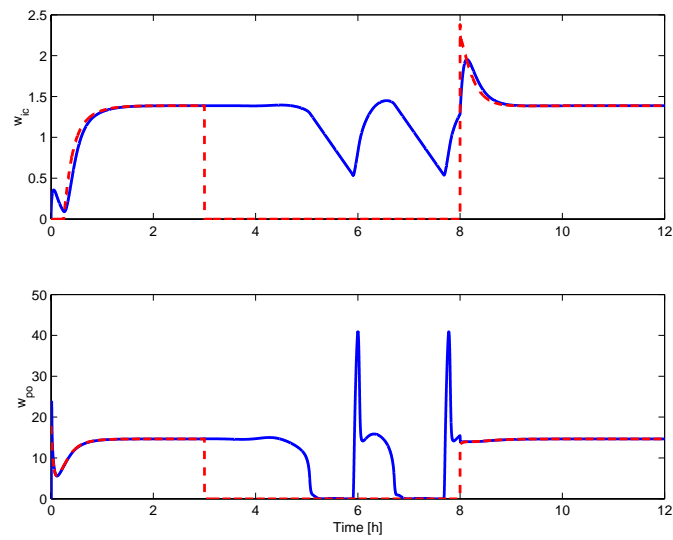

Figure 6.17: Desired oil production calculated by controller (- -) and the “real” production (-), simple model simulation

6.6.7 OLGA simulations

Using the OSI¹² link between OLGA and Matlab, the controller, implemented in Matlab, was used on a well (modeled in OLGA) similar to the one studied with the simple model. The simulation results are shown in Figures 6.18-6.21. Note that these are state feedback simulation results, the masses and flows were assumed measured.

In the simulations, the well is operated open loop the two first hours. In this period, the well is stabilized by using a high opening of the gas lift choke ($u_1 = 0.7$) and a low opening of the production choke ($u_2 = 0.4$). Then, the controller (with $M_g^* = 3450$ kg and $M_o^* = 9400$ kg) is switched on, and remains on for three hours. We see that the controller stabilizes the well at a higher production, and with a significantly lower use of injection gas. The controller is switched off after 5 hours, keeping the inputs constant. It is seen that this operating point is open loop unstable.

The simulations confirm the results from using the simple model. However, there are some remarks that should be made.

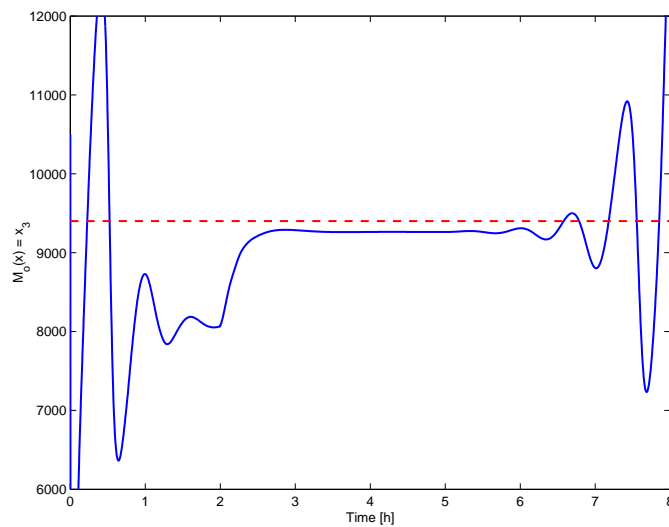

Figure 6.18: Mass of oil vs. setpoint, OLGA simulation

In Figure 6.18 and 6.19, we see that the controller does not quite reach the mass setpoints. This is due to that the OLGA simulator includes flashing, hence there is mass leaving the oil phase which enters the gas phase, which the controller does not account for. This can be interpreted as errors in the

¹²OLGA Server Interface (OSI) toolbox, for use with Matlab, developed by ABB Corporate Research.

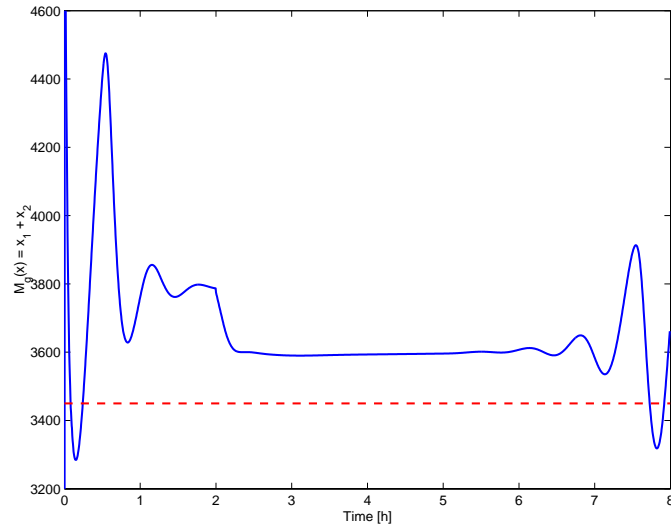

Figure 6.19: Total mass of gas vs. setpoint, OLGA simulation

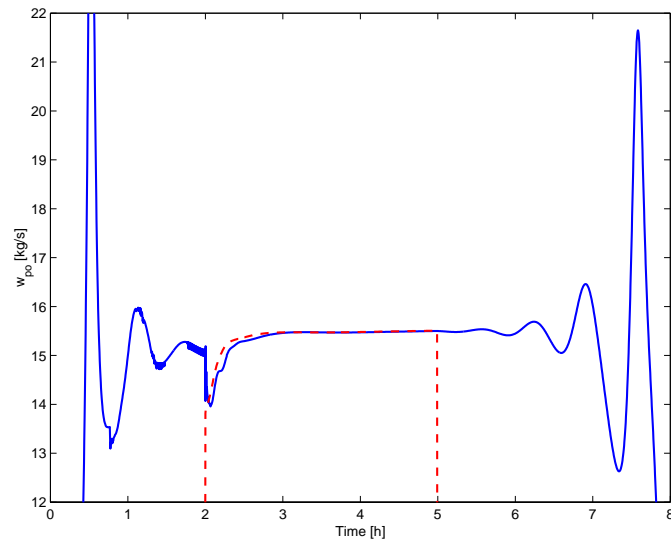

Figure 6.20: Desired oil production calculated by controller (- -) and the “real” production (-), OLGA simulation

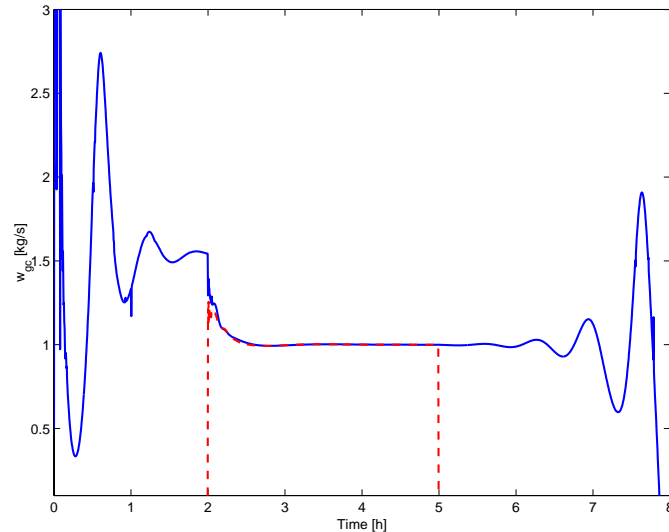

Figure 6.21: Desired gas injection calculated by controller (- -) and the “real” injection (-), OLGA simulation

external flows, which the controller is robust to, in the sense of Section 6.4.2. The influence is largest in the gas phase, since the external flows in the oil phase is larger than in the gas phase. Simulations indicate that larger λ 's (like for the simple model, $\lambda_1 = \lambda_2 = 0.001$ was used in the simulations shown) reduces the steady state error. Choosing too high λ 's leads to problems with saturations, and also numerical problems may occur. However, increasing the λ 's by, say, a decade do not introduce problems. Another remedy for reducing this offset is by including an estimate of the flashing, as in Remark 6.7.

Another point that is not revealed by the simulations shown is that the closed loop does not reach a steady state. After an initial time period, the choke openings start to (slowly) drift. This effect is believed to be caused by the fact that both “local” choke controllers have integral action. At a steady state, the inflow of gas through the gas lift choke is at a constant rate to the outflow of oil through the production choke. Hence, at the steady state, the choke controllers essentially control the same variable, and can as such be considered parallel controllers. As is well known, two integral controllers in a parallel control structure cannot lead to a steady state in the presence of disturbances (Balchen and Mummé, 1988, p.35). The effect is barely visible in the short time simulations shown, but longer simulations would show it more clearly. Attempts were made to circumvent the problem by introducing a P-controller with high gain in stead of the PI-controllers used. This was

unsuccessful, since the high gain leads to numerical problems in OLGA.

6.6.8 Discussion of gas-lift stabilization controller

Both analysis on the simple model, and simulations on the multiphase flow simulator OLGA as well as the simple model, confirm that the developed controller stabilizes the flow in the gas-lifted well.

The controller calculates the desired inflow of gas to the annulus, and the desired outflow of oil from the tubing. It was chosen to use inner control loops to obtain these desired flows, which means the total control structure could be seen as a cascaded design. Because of choke rate saturation (the choke stroke time in the OLGA simulations was 7 min.), these inner control loops cannot be infinitely fast, but simulations show that the delays introduced by these rate saturations does not have a significant influence on the closed loop behavior. These inner control loops cannot both be integral controllers, since the steady state value of the controlled variables are dependent.

Note that the developed state feedback controller is independent of the flow through the injection valve, $w_{iv}(x)$, and hence is robust to modeling errors in this flow. This is in contrast to the fact that the system can be open loop stabilized (or destabilized) by the characteristics of this valve. In some cases this valve is designed to be always in a critical flow condition, effectively decoupling the annulus dynamics from the tubing dynamics. Even though this takes care of the instability problem, operational degrees of freedom are lost compared to the approach herein since it implies a constant, given at the design stage, gas injection into the tubing.

In the controller, the states (masses) and expressions for the external flows are needed. For a real well, these are not easily obtained by measurements. However, in modern oil industry there is a development towards advanced production systems, where these variables are kept track of by some means. Another alternative is to design a nonlinear state observer based on the simple nonlinear model developed in Appendix B, for example an extended Kalman filter.

Much work remains on the connection between the mass setpoints (M_g^* and M_o^*) and the performance of the well. In the simulations shown, an unsatisfactorily “trial-and-error”-method was used to find these values.

An approach where the oil and gas are treated as a single phase can also be developed by the theory in this chapter. In such a setup, the production choke must be used to control the (total) outflow of mass. Simulations (not included herein) show that this control strategy also stabilizes the well. Such a control strategy can be advantageous, since there can be situations where the gas lift choke is not available for control, for example due to that the

amount of available lift gas topside can be given by production constraints. Other advantages are that the controller is independent (and hence robust) to mass transfer between the oil and gas phase in the tubing, and that tuning (in terms of total mass setpoint) is significantly easier. The expected disadvantages are a smaller region of attraction, and that the achievable performance of the well (the oil production) is lower.

6.7 Discussion and concluding remarks

A controller for a class of positive systems is suggested leading to closed loop stability of a set. The main restriction of the system class is the assumptions (Assumption A3) that ensure that the “Lyapunov function” used in the proof of the main result is decreasing when the input saturates. The way these assumptions are used in the proof of Theorem 6.1, indicates that it should be possible to get less conservative conditions, at least if a specific system is considered.

The closed loop convergence holds independently of the rate-of-convergence parameter λ_j . This means that this parameter (at least nominally) can be used to shape the closed loop performance in terms of the convergence of the mass of each phase, without affecting stability.

The closed loop system has some robustness properties, as outlined in Section 6.4.2. Most important is the robustness to unmodeled interconnection terms, since these in practice typically are the terms that are hardest to model, as for instance in the gas-lift case in Section 6.6. The examination of robustness to bounded perturbations in the controlled and uncontrolled flows, is done under an assumption of unconstrained inputs. Further investigations are necessary to state what robustness is present (under which conditions) when the constraints are taken into consideration.

The suggested approach leads to stability of a compact set. The approach does not give any guarantees pertaining to the behavior *on* this set, apart from boundedness. However, if the set contains an equilibrium that is asymptotically stable with respect to the set, the equilibrium is also asymptotically stable in the original state space.

Each control input is connected to a subset of the state, called a phase. In the closed loop, this input is controlling the mass of that phase. Hence, the approach could be interpreted as a *distributed* approach. However, each of the inputs could in general depend on the total state.

Chapter 7

Conclusion

This thesis has presented contributions within three different areas in the field of nonlinear control. The aim of this chapter is to briefly sum up the contributions, and mention some of the main issues. The reader is referred to the end of each chapter for further discussion and conclusions.

7.1 Piecewise affine output feedback

In Chapter 3, synthesis inequalities are developed for observer-based output feedback for a class of piecewise affine difference inclusions, by using a result presented in Chapter 2. The approach is rather general in the sense that a large system class can be handled, but its application is of course limited to those problems where it is possible to find a feasible solution to the synthesis inequalities. The non-convex nature of the inequalities can make it hard to find solutions even when there exist feasible solutions, but the non-convexity has structure and the number of variables and equations involved in the nonconvex part is small compared to the total problem size. A solver is developed that exploits the structure of the non-convex equations.

Another drawback adding to the conservatism is that the piecewise affine structure is not exploited in the parameterization of the Lyapunov function. Since both model and controller has a piecewise affine structure, it is a natural next step to also consider Lyapunov functions with a “piecewise” structure (for example piecewise quadratic). However, the structure of the matrix inequalities given herein does not easily generalize to such Lyapunov functions.

7.2 Output feedback NMPC

In Chapter 4, it is established that by assuming a continuous implementation of the NMPC control law and considering a special system class, the nonlinear separation principle of Atassi and Khalil (1999) also holds for NMPC state feedback laws under a continuity assumption on the solution of the NMPC open loop optimization problem. Further, the closed loop also has some robustness properties.

This work is continued in Chapter 5, where the more usual “sampled-data” implementation of NMPC is considered. It is shown that under a strong observability assumption and under similar continuity conditions as in Chapter 4, a closed loop with the NMPC state feedback and a high gain observer is semiglobally practically stable. It is also shown, under some stronger assumptions, that the state and observer error actually converge to the equilibrium.

The results are close to a special separation principle for NMPC since state feedback NMPC can be used in the normal fashion. However, this cannot be called a nonlinear separation principle for NMPC in general, since the NMPC state feedback controller in the general case in addition to the control signal must deliver (bounded) input derivatives. In the case where the observability mapping is independent of the input derivatives (which is the case for the system class in Chapter 4), it can be argued that this is a nonlinear separation principle for NMPC for the considered class of systems.

7.3 State feedback control of a class of positive systems

A state feedback controller for a class of systems with positive state variables is proposed. The controller achieves set stability, that is, with initial conditions in a region of attraction, the state converges to the compact set. Furthermore, the set is stable, which together with the convergence imply asymptotic stability of the set. If the compact set contains an equilibrium that is asymptotically stable with respect to the set, the equilibrium is also asymptotically stable with the same region of attraction as the set.

The controller has some robustness properties. In particular, it is completely independent of parts of the system model. Some initial results on robustness to uncertainties of other parts of the system are also given, but further investigations should be performed.

The controller is evaluated on several examples. In particular the stabilization of a gas lifted oil well is treated in detail, and demonstrates several

properties of the controller. However, further work on the relation between system performance and controller parameters is needed, in addition to the consideration of uncertainties and observers.

Bibliography

- Alizadeh, F., Haeberly, J.-P. A. and Overton, M. L. (1998). Primal-dual interior-point methods for semidefinite programming: convergence rates, stability and numerical results, *SIAM J. Optim.* **8**(3): 746–768.
- Allgöwer, F., Badgwell, T. A., Qin, J. S., Rawlings, J. B. and Wright, S. J. (1999). Nonlinear predictive control and moving horizon estimation—an introductory overview, in P. M. Frank (ed.), *Advances in Control: Highlights of ECC'99*, Springer.
- Apkarian, P. and Tuan, H. D. (1999). Concave programming in control theory, *J. Global Optim.* **15**(4): 343–370.
- Apkarian, P. and Tuan, H. D. (2000a). Parameterized LMIs in control theory, *SIAM J. Control Optim.* **38**(4): 1241–1264.
- Apkarian, P. and Tuan, H. D. (2000b). Robust control via concave minimization local and global algorithms, *IEEE Trans. Aut. Control* **45**(2): 299–305.
- Atassi, A. N. and Khalil, H. K. (1999). A separation principle for the stabilization of a class of nonlinear systems, *IEEE Trans. Aut. Control* **44**(9): 1672–1687.
- Balchen, J. and Mummé, K. (1988). *Process Control: Structures and Applications*, VanNostrand and Reinhold Company, New York.
- Bastin, G. (1999). Issues in modelling and control of mass balance systems, in D. Aeyels, F. Lamnabi-Lagarrigue and A. van der Schaft (eds), *Stability and stabilization of Nonlinear Systems*, Springer.
- Bastin, G. and Praly, L. (1999). Feedback stabilisation with positive control of a class of dissipative mass-balance systems, *Proceedings of the 14th IFAC World Congress, Beijing, P. R. China*.

- Bastin, G. and Provost, A. (2002). Feedback stabilisation with positive control of dissipative compartmental systems, *Electronic Proceedings of 15th International Symposium on the Mathematical Theory of Networks and Systems, University of Notre Dame, South Bend, Indiana, USA, August 12-16*.
- Bemporad, A., Ferrari-Trecate, G. and Morari, M. (2000). Observability and controllability of piecewise affine and hybrid systems, *IEEE Trans. Aut. Control* **45**(10): 1864–1876.
- Bemporad, A., Morari, M., Dua, V. and Pistikopoulos, E. N. (2002). The explicit linear quadratic regulator for constrained systems, *Automatica* **38**(1): 3–20.
- Bendiksen, K., Malnes, D., Moe, R. and Nuland, S. (1991). The dynamic two-fluid model OLGA: Theory and application, *SPE Production Engineering* pp. 171–180.
- Blondel, V. D. and Tsitsiklis, J. N. (1999). Three problems on the decidability and complexity of stability, *Open problems in mathematical systems and control theory*, Springer, London, pp. 45–51.
- Boyd, S., El Ghaoui, L., Feron, E. and Balakrishnan, V. (1994). *Linear Matrix Inequalities in System and Control Theory*, number 15 in *SIAM Studies in Applied Mathematics*, SIAM.
- Bru, R., Caccetta, L., Romero, S., Rumchev, V. and Sánchez, E. (2002). Recent developments in reachability and controllability of positive linear systems, *Proceedings of the IFAC 15th World Congress*, Barcelona, Spain.
- Chabour, R. and Kalitine, B. (2002). Semi-definite Lyapunov functions - stability and stabilizability, *IEEE Trans. Aut. Control*. To appear.
- Chen, C. C. and Shaw, L. (1982). On receding horizon feedback control, *Automatica* **18**(3): 349–352.
- Chen, H. (1997). *Stability and Robustness Considerations in Nonlinear Model Predictive Control*, PhD thesis, University of Stuttgart, Düsseldorf.
- Chen, H. and Allgöwer, F. (1998a). Nonlinear model predictive control schemes with guaranteed stability, in R. Berber and C. Kravaris (eds), *Nonlinear Model Based Process Control*, Kluwer Academic Publishers, Dordrecht, pp. 465–494.

-
- Chen, H. and Allgöwer, F. (1998b). A quasi-infinite horizon nonlinear model predictive control scheme with guaranteed stability, *Automatica* **34**(10): 1205–1217.
- Chen, H., Kremling, A. and Allgöwer, F. (1995). Nonlinear predictive control of a benchmark CSTR, *Proc. 3rd European Control Conference ECC'95*, pp. 3247–52.
- Ciccarella, G., Dalla Mora, M. and Germani, A. (1993). A Luenberger-like observer for nonlinear systems, *Internat. J. Control* **57**(3): 537–556.
- Clarke, F. H., Ledyaev, Y. S., Sontag, E. D. and Subbotin, A. I. (1997). Asymptotic controllability implies feedback stabilization, *IEEE Trans. Aut. Control* **42**(10): 1394–1407.
- Corless, M. (1994). Robust stability analysis and controller design with quadratic Lyapunov functions, in A. S. I. Zinober (ed.), *Variable Structure and Lyapunov Control*, number 193 in *Lecture Notes in Control and Information Sciences*, Springer-Verlag, London, chapter 9.
- Corless, M. J. and Leitmann, G. (1981). Continuous state feedback guaranteeing uniform ultimate boundedness for uncertain dynamic systems, *IEEE Trans. Aut. Control* **26**(5): 1139–1144.
- De Leenheer, P. and Aeyels, D. (2002). Stabilization of positive systems with first integrals, *Automatica* **38**(9): 1583–1589.
- De Nicolao, G., Magni, L. and Scattolini, R. (2000). Stability and robustness of nonlinear receding horizon control, *Nonlinear model predictive control (Ascona, 1998)*, Birkhäuser, Basel, pp. 3–22.
- de Oliveira Kothare, S. L. and Morari, M. (2000). Contractive model predictive control for constrained nonlinear systems, *IEEE Trans. Aut. Control* **45**(6): 1053–1071.
- Desoer, C. A. and Vidyasagar, M. (1975). *Feedback systems: input-output properties*, Academic Press [Harcourt Brace Jovanovich Publishers], New York. Electrical Science.
- Doyle, III, F. J., Ogunnaike, B. A. and Pearson, R. K. (1995). Nonlinear model-based control using second-order Volterra models, *Automatica* **31**(5): 697–714.
- Doyle, J., Packard, A. and Zhou, K. (1991). Review of LFTs, LMIs and μ , *Proc. 30th IEEE Conf. Decision Contr.*, pp. 1227–1232.

- Dussy, S. and El Ghaoui, L. (1996). Robust gain-scheduled control of a class of nonlinear parameter-dependent systems: application to an uncertain inverted pendulum, *Proceedings of the 1996 IEEE International Conference on Control Applications*, pp. 516–521.
- Dvergsnes, S. (1999). *Modeling and control of gas-lifted oilwells*, Master's thesis, Department of Engineering Cybernetics.
- Eikrem, G. O., Foss, B. A., Imsland, L., Bin, H. and Golan, M. (2002). Stabilization of gaslifted wells, *Proceedings of the IFAC 15th World Congress*, Barcelona, Spain.
- El Ghaoui, L. and Balakrishnan, V. (1994). Synthesis of fixed-structure controllers via numerical optimization, *Proc. 33rd IEEE Conf. Decision Contr.*, Orlando, Florida, pp. 2678–2683.
- El Ghaoui, L., Oustry, F. and AitRami, M. (1997). A cone complementary linearization algorithm for static output-feedback and related problems, *IEEE Trans. Aut. Control* **42**(8): 1171–6.
- Esfandiari, F. and Khalil, H. K. (1992). Output feedback stabilization of fully linearizable systems, *Internat. J. Control* **56**(5): 1007–1037.
- Fares, B., Apkarian, P. and Noll, D. (2001). An augmented Lagrangian method for a class of LMI-constrained problems in robust control theory, *Internat. J. Control* **74**(4): 348–360.
- Farina, L. (2002). Positive systems in the state space approach: Main issues and recent results, *Electronic Proceedings of 15th International Symposium on the Mathematical Theory of Networks and Systems, University of Notre Dame, South Bend, Indiana, USA, August 12-16*.
- Ferrari-Trecate, G., Cuzzola, F. A., Mignone, D. and Morari, M. (2001). Analysis and control with performance of piecewise affine and hybrid systems, *Proc. Amer. Contr. Conf.*, Vol. 1, Arlington (VA), US., pp. 200–205.
- Findeisen, R. (2002). *Stability, Robustness, Output Feedback and Computational Efficiency in Sampled Data Nonlinear Model Predictive Control*, PhD thesis, University of Stuttgart.
- Findeisen, R., Imsland, L., Allgöwer, F. and Foss, B. (2002a). Output feedback nonlinear predictive control - a separation principle approach, *Proceedings of the IFAC 15th World Congress*, Barcelona, Spain.

-
- Findeisen, R., Imstand, L., Allgöwer, F. and Foss, B. (2002b). Output feedback stabilization of constrained systems with nonlinear predictive control, *Internat. J. Robust Nonlinear Control*. Submitted.
- Fontes, F. A. C. C. (2000). A general framework to design stabilizing nonlinear model predictive controllers, *Systems Control Lett.* **42**(2): 127–143.
- Gahinet, P. and Apkarian, P. (1994). A linear matrix inequality approach to \mathcal{H}_∞ control, *Internat. J. Robust Nonlinear Control* **4**(4): 421–448.
- Gahinet, P., Apkarian, P. and Chilali, M. (1996). Affine parameter-dependent Lyapunov functions and real parametric uncertainty, *IEEE Trans. Aut. Control* **41**(3): 436–442.
- Glad, S. (1987). Robustness of nonlinear state feedback - a survey, *Automatica* **23**: 425–435.
- Godfrey, K. (1983). *Compartmental models and their application*, Academic Press Inc. [Harcourt Brace Jovanovich Publishers], London.
- Goh, K. C., Safonov, M. G. and Papavassilopoulos, G. P. (1994). A global optimization approach for the BMI problem, *Proc. 33rd IEEE Conf. Decision Contr.*, pp. 2009–14.
- Golan, M. and Whitson, C. H. (1991). *Well Performance*, 2nd edn, Prentice-Hall.
- Gutman, S. (1979). Uncertain dynamical systems—a Lyapunov min-max approach, *IEEE Trans. Aut. Control* **24**(3): 437–443.
- Hahn, W. (1967). *Stability of motion*, Springer-Verlag New York, Inc., New York.
- Hassibi, A. and Boyd, S. (1998). Quadratic stabilization and control of piecewise-linear systems, *Proc. Amer. Contr. Conf.*
- Horn, R. A. and Johnson, C. R. (1991). *Topics in matrix analysis*, Cambridge University Press, Cambridge.
- Hu, B., Eikrem, G. O. and Imstand, L. (2001). A study of the casing heading problem of gas lifted wells, *Technical Report 2001-6-T*, Department of Engineering Cybernetics, Norwegian University of Science and Technology.
- Iggidr, A., Kalitine, B. and Outbib, R. (1996). Semidefinite Lyapunov functions: stability and stabilization, *Math. Control Signals Systems* **9**(2): 95–106.

- Imsland, L., Findeisen, R., Allgöwer, F. and Foss, B. (2002). Output feedback stabilization with nonlinear predictive control - asymptotic properties. In preparation.
- Imsland, L., Findeisen, R., Bullinger, E., Allgöwer, F. and Foss, B. (2001a). A note on stability, robustness and performance of output feedback nonlinear model predictive control, Accepted for Publication in Journal of Process Control.
- Imsland, L., Findeisen, R., Bullinger, E., Allgöwer, F. and Foss, B. (2001b). On output feedback nonlinear model predictive control using high gain observers for a class of systems, *6th IFAC Symposium on Dynamics and Control of Process Systems, DYCOPS-6*, Jeju-do, Korea, pp. 91–96.
- Imsland, L., Slupphaug, O. and Foss, B. A. (2001c). Piecewise affine observer-based robust controllers for constrained nonlinear systems, *MIC—Model. Identif. Control* **22**(4): 211–225.
- Imsland, L., Slupphaug, O. and Foss, B. A. (2001d). Piecewise affine observer-based robust controllers for constrained nonlinear systems, *Proc. 5th European Control Conference ECC'99*, Porto, Portugal.
- Imsland, L., Slupphaug, O. and Foss, B. A. (2001e). Robust observer-based output feedback for nonlinear discrete-time systems with constraints, *Proceedings of the 5th IFAC Nonlinear Control Systems Design Symposium (NOLCOS)*, St. Petersburg, Russia.
- Isidori, A. (1995). *Nonlinear control systems*, third edn, Springer-Verlag, Berlin.
- Iwasaki, T. and Skelton, R. E. (1994). All controllers for the general \mathcal{H}_∞ control problem: LMI existence conditions and state space formulas, *Automatica* **30**(8): 1307–1317.
- Jacquez, J. A. and Simon, C. P. (1993). Qualitative theory of compartmental systems, *SIAM Rev.* **35**(1): 43–79.
- Jadbabaie, A., Yu, J. and Hauser, J. (2001). Unconstrained receding-horizon control of nonlinear systems, *IEEE Trans. Aut. Control* **46**(5): 776–783.
- Jansen, B., Dalsmo, M., Nøkleberg, L., Havre, K., Kristiansen, V. and Lemetayer, P. (1999). Automatic control of unstable gas lifted wells, *SPE Annual Technical Conference and Exhibition*, Society of Petroleum Engineers Inc. Paper number: SPE 56832.

-
- Johansen, T. A. (2000). Computation of Lyapunov functions for smooth nonlinear systems using convex optimization, *Automatica* **36**(11): 1617–1626.
- Johansen, T. A., Petersen, I. and Slupphaug, O. (2002). Explicit suboptimal linear quadratic regulation with input and state constraints, *Automatica* **38**(7): 1099–1111.
- Johansson, M. (1999). *Piecewise Linear Control Systems*, PhD thesis, Lund Institute of Technology.
- Johansson, M. and Rantzer, A. (1998). Computation of piecewise quadratic Lyapunov functions for hybrid systems, *IEEE Trans. Aut. Control* **43**(4): 555–559.
- Khalil, H. K. (1996). *Nonlinear Systems*, 2nd edn, Prentice Hall, Upper Saddle River, NJ 07458.
- Khalil, H. K. (2002). *Nonlinear Systems*, 3rd edn, Prentice Hall, Upper Saddle River, NJ 07458.
- Kothare, M. V., Balakrishnan, V. and Morari, M. (1996). Robust constrained model predictive control using linear matrix inequalities, *Automatica* **32**(10): 1361–79.
- Kouvaritakis, B., Rossiter, J. A. and Schuurmans, J. (2000). Efficient robust predictive control, *IEEE Trans. Aut. Control* **45**(8): 1545–1549.
- Krstić, M., Kanellakopoulos, I. and Kokotović, P. (1995). *Nonlinear and Adaptive Control Design*, Wiley-Interscience, New York.
- LaSalle, J. and Lefschetz, S. (1961). *Stability by Liapunov's direct method, with applications*, Academic Press, New York.
- LaSalle, J. P. (1960). Some extensions of Liapunov's second method, *IRE Trans.* **CT-7**: 520–527.
- Luenberger, D. (1979). *Introduction to dynamic systems*, John Wiley & Sons.
- Luenberger, D. G. (1966). Observers for multivariable systems, *IEEE Trans. Aut. Control* **AC-11**(2): 190–197.
- Maeda, H., Kodama, S. and Ohta, Y. (1978). Asymptotic behavior of nonlinear compartmental systems: nonoscillation and stability, *IEEE Trans. Circuits and Systems* **25**(6): 372–378.

- Maggiore, M. and Passino, K. (2001). Robust output feedback control of incompletely observable nonlinear systems without input dynamic extension, *Systems and Control Letters*, submitted for publication.
- Magni, L. and Sepulchre, R. (1997). Stability margins of nonlinear receding-horizon control via inverse optimality, *Systems Control Lett.* **32**(4): 241–245.
- Magni, L., De Nicolao, D. and Scattolini, R. (1998). Output feedback receding-horizon control of discrete-time nonlinear systems, *Preprints of the 4th Nonlinear Control Systems Design Symposium 1998 - NOLCOS'98*, IFAC, pp. 422–427.
- Magni, L., De Nicolao, G. and Scattolini, R. (2001). Output feedback and tracking of nonlinear systems with model predictive control, *Automatica* **37**(10): 1601–1607.
- Mayne, D. Q. and Michalska, H. (1990). Receding horizon control of nonlinear systems, *IEEE Trans. Aut. Control* **35**(7): 814–24.
- Mayne, D. Q., Rawlings, J. B., Rao, C. V. and Sokaert, P. O. M. (2000). Constrained model predictive control: stability and optimality, *Automatica* **36**(6): 789–814.
- Michalska, H. and Mayne, D. Q. (1993). Robust receding horizon control of constrained nonlinear systems, *IEEE Trans. Aut. Control* **38**(11): 1623–1633.
- Michalska, H. and Mayne, D. Q. (1995). Moving horizon observers and observer-based control, *IEEE Trans. Aut. Control* **40**(6): 995–1006.
- Nesterov, Y. and Nemirovskii, A. (1994). *Interior-point Polynomial Algorithms in Convex Programming*, vol. 13 of Studies in Applied Mathematics, SIAM, Philadelphia, PA.
- Nocedal, J. and Wright, S. J. (1999). *Numerical Optimization*, Springer-Verlag, New York.
- Ortega, R., Astolfi, A., Bastin, G. and Rodriguez-Cortes, H. (1999). Output feedback control of food-chain systems, in H. Nijmeier and T. Fossen (eds), *New Directions in Nonlinear Observer Design*, Lecture Notes in Control and Information Sciences, Springer Verlag, pp. 291 – 310.
- Ortega, R., Van Der Schaft, A., Mareels, I. and Maschke, B. (2001). Putting energy back in control, *IEEE Control Systems Magazine* **21**(2): 18–33.

-
- Perko, L. (1996). *Differential equations and dynamical systems*, second edn, Springer-Verlag, New York.
- Petersen, I., Johansen, T. A., Kalkkuhl, J. and Lüdemann, J. (2001). Wheel slip control in ABS brakes using gain scheduled constrained LQR, *Proceedings of the European Control Conference 2001*, Porto, Portugal.
- Primbs, J., Nevistić, V. and Doyle, J. (1999). Nonlinear optimal control: A control Lyapunov function and receding horizon perspective, *Asian Journal of Control* **1**(1): 14–24.
- Qin, S. J. and Badgwell, T. A. (1996). An overview of industrial model predictive control technology, *CPC-V. Tahoe City, CA, USA*.
- Rantzer, A. and Johansson, M. (2000). Piecewise linear quadratic optimal control, *IEEE Trans. Aut. Control* **45**(4): 629–637.
- Rodrigues, L. and How, J. P. (2001). Observer-based control of piecewise-affine systems, *Proc. 40th IEEE Conf. Decision Contr.*
- Rouche, N., Habets, P. and Laloy, M. (1977). *Stability theory by Liapunov's direct method*, Springer-Verlag, New York. Applied Mathematical Sciences, Vol. 22.
- Scandpower (2000). *OLGA 2000 user's manual*.
- Scherer, C. and Weiland, S. (1999). *Lecture Notes DISC Course on Linear Matrix Inequalities in Control*. *<http://www.er.ele.tue.nl/sweiland/lmi99.htm>.
- Scherer, C. W. (2001). LPV control and full block multipliers, *Automatica* **37**(3): 361–375.
- Scokaert, P. O. M., Mayne, D. Q. and Rawlings, J. B. (1999). Suboptimal model predictive control (feasibility implies stability), *IEEE Trans. Aut. Control* **44**(3): 648–654.
- Scokaert, P. O. M., Rawlings, J. B. and Meadows, E. S. (1997). Discrete-time stability with perturbations: application to model predictive control, *Automatica* **33**(3): 463–470.
- Sepulchre, R., Janković, M. and Kokotović, P. V. (1997). *Constructive nonlinear control*, Springer-Verlag, Berlin.
- Shevitz, D. and Paden, B. (1994). Lyapunov stability theory of nonsmooth systems, *IEEE Trans. Aut. Control* **39**(9): 1910–1914.

- Shim, H. and Teel, A. (2001a). Asymptotic controllability and observability imply semiglobal practical asymptotic stabilizability, Submitted to *Automatica*.
- Shim, H. and Teel, A. (2001b). On performance improvement of an output feedback control scheme for non-uniformly observable nonlinear systems, *Proc. 40th IEEE Conf. Decision Contr.*, Orlando, Florida.
- Slupphaug, O. and Foss, B. A. (1999). Constrained quadratic stabilization of discrete-time uncertain nonlinear multi-model systems using piecewise affine state-feedback, *Internat. J. Control* **72**(7/8): 686–701.
- Slupphaug, O. (1998). *On Robust Constrained Nonlinear Control and Hybrid Control: BMI- and MPC-based State-Feedback Schemes*, PhD thesis, Norwegian University of Science and Technology, Department of Engineering Cybernetics.
- Slupphaug, O., Imsland, L. and Foss, B. A. (2000). Uncertainty modelling and robust output feedback control of nonlinear discrete systems: a mathematical programming approach, *Internat. J. Robust Nonlinear Control* **10**(13): 1129–1152.
- Sontag, E. D. (1981). Nonlinear regulation: the piecewise linear approach, *IEEE Trans. Aut. Control* **26**(2): 346–358.
- Sontag, E. D. (2001). Structure and stability of certain chemical networks and applications to the kinetic proofreading model of T-cell receptor signal transduction, *IEEE Trans. Aut. Control* **46**(7): 1028–1047.
- Taitel, Y. (2001). Multiphase flow modeling - fundamentals and applications to oil production systems. Course Manual.
- Teel, A. (2001). *Lecture notes ECE236 Nonlinear Control Systems*, University of California, Santa Barbara.
- Teel, A. and Praly, L. (1994). Global stabilizability and observability imply semi-global stabilizability by output feedback, *Systems Control Lett.* **22**(4): 313–325.
- Teel, A. and Praly, L. (1995). Tools for semiglobal stabilization by partial state and output feedback, *SIAM J. Contr. Optim.* **33**(5): 1443–1488.
- Teel, A. R. and Praly, L. (2000). A smooth Lyapunov function from a class- \mathcal{KL} estimate involving two positive semidefinite functions, *ESAIM Control Optim. Calc. Var.* **5**: 313–367.

-
- Tornambè, A. (1992). Output feedback stabilization of a class of nonminimum phase nonlinear systems, *Systems Control Lett.* **19**(3): 193–204.
- Tuan, H. D., Apkarian, P., Hosoe, S. and Tuy, H. (2000). d.c. optimization approach to robust control: feasibility problems, *Internat. J. Control* **73**(2): 89–104.
- Utkin, V. I. (1992). *Sliding modes in control and optimization*, Springer-Verlag, Berlin. Translated and revised from the 1981 Russian original.
- van der Schaft, A. (2000). *L₂-gain and passivity techniques in nonlinear control*, second edn, Springer-Verlag London Ltd., London.
- Wolkowicz, H., Saigal, R. and Vandenberghe, L. (eds) (2000). *Handbook of Semidefinite Programming*, Vol. 27 of *International series in operations research and management science*, Kluwer, Boston, MA.
- Wonham, W. M. (1985). *Linear multivariable control*, third edn, Springer-Verlag, New York. A geometric approach.
- Ydstie, B. E. and Alonso, A. A. (1997). Process systems and passivity via the Clausius-Planck inequality, *Systems Control Lett.* **30**(5): 253–264.

Appendix A

The Gradient and Hessian of the Augmented Lagrangian Function

Consider the scalar function

$$\Phi_c(P, S, \Delta) = \text{trace} \left[\Lambda(P S + \Delta S - I) + \frac{c}{2}(P S + \Delta S - I)^\top (P S + \Delta S - I) \right]$$

where P , S and Δ are symmetric matrices, and I is the identity matrix of the same dimension. The first derivatives of this function can be computed to

$$\begin{aligned} \frac{\partial \Phi_c(P, S, \Delta)}{\partial \text{svec } P} &= \frac{T^2}{2} \text{svec} \left(\Lambda^\top S + S \Lambda \right) \\ &\quad + \frac{c}{2} T^2 \text{svec} \left((P + \Delta) S^2 + S^2 (P + \Delta) - 2S \right) \end{aligned}$$

$$\begin{aligned} \frac{\partial \Phi_c(P, S, \Delta)}{\partial \text{svec } S} &= \frac{T^2}{2} \text{svec} \left(\Lambda P + P \Lambda^\top \right) + \frac{T^2}{2} \text{svec}(\Lambda \Delta + \Delta \Lambda^\top) \\ &\quad + \frac{c}{2} T^2 \text{svec} \left(S (P + \Delta)^2 + (P + \Delta)^2 S - 2(P + \Delta) \right) \end{aligned}$$

$$\begin{aligned} \frac{\partial \Phi_c(P, S, \Delta)}{\partial \text{svec } \Delta} &= \frac{T^2}{2} \text{svec} \left(\Lambda^\top S + S \Lambda \right) \\ &\quad + \frac{c}{2} T^2 \text{svec} \left((P + \Delta) S^2 + S^2 (P + \Delta) - 2S \right). \end{aligned}$$

Further, the second and mixed derivatives can be computed to:

$$\begin{aligned}
\frac{\partial^2 \Phi_c(P, S, \Delta)}{(\partial \text{svec } P)^2} &= cT(S^2 \otimes I)T \\
\frac{\partial^2 \Phi_c(P, S, \Delta)}{(\partial \text{svec } S)^2} &= cT \left((P + \Delta)^2 \otimes I \right) T \\
\frac{\partial^2 \Phi_c(P, S, \Delta)}{(\partial \text{svec } \Delta)^2} &= cT(S^2 \otimes I)T \\
\frac{\partial^2 \Phi_c(P, S, \Delta)}{(\partial \text{svec } P)(\partial \text{svec } S)} &= T[\Lambda \otimes I + c(((P + \Delta)S - I) \otimes I) \\
&\quad + c((P + \Delta) \otimes S)]T \\
\frac{\partial^2 \Phi_c(P, S, \Delta)}{(\partial \text{svec } P)(\partial \text{svec } \Delta)} &= cT(S^2 \otimes I)T \\
\frac{\partial^2 \Phi_c(P, S, \Delta)}{(\partial \text{svec } S)(\partial \text{svec } \Delta)} &= T[\Lambda \otimes I + c((S(P + \Delta) - I) \otimes I) \\
&\quad + c(S \otimes (P + \Delta))]T.
\end{aligned}$$

In the above, the symmetric Kronecker product (Alizadeh, Haeberly and Overton, 1998, Fares et al., 2001) is used, which is defined by

$$(U \otimes V)T \text{svec } X = T \text{svec } \frac{1}{2}(UXV^\top + VXU^\top),$$

where svec is a linear operator $S^n \rightarrow \mathbb{R}^{n(n+1)/2}$ defined by

$$\text{svec } X = [X_{11}, X_{12}, \dots, X_{1n}, X_{22}, X_{23}, \dots, X_{nn}]^\top,$$

basically mapping the upper right half of the symmetric input matrix into a vector. The diagonal matrix

$$T = \text{diag}[1, \sqrt{2}, \dots, \sqrt{2}, 1, \sqrt{2}, \dots, 1]^\top$$

is defined accordingly with ones on the places corresponding to the elements on the diagonal of a symmetric matrix mapped with svec , and $\sqrt{2}$ on the above-diagonal corresponding places.

Appendix B

A Simple Model for Pressure Drop in a Vertical Well with Two-phase Flow

B.1 Introduction

To illustrate the background for the modeling, consider a vertical volume (see Figure B.1) with oil and gas entering at the bottom with mass rates $w_{g,in}$ and $w_{o,in}$ and leaving at the top with mass rates $w_{g,out}$ and $w_{o,out}$. In general, we might have mass transfer between the phases, denoted w_{og} . The mass of gas and oil is denoted m_g and m_o .

On this basis, we write a mass balance for each phase:

$$\dot{m}_g = w_{g,in} - w_{g,out} + w_{og} \quad (\text{B.1})$$

$$\dot{m}_o = w_{o,in} - w_{o,out} - w_{og}. \quad (\text{B.2})$$

We see that we need an expression for the flows.

The flow is entering and leaving the volume through some kind of orifice, typically a valve or a choke. For single phase flow, the flow can (typically) be a function of the pressure on each side of the orifice, and the density of the inflow. For instance, the flow w through a valve can be given by

$$w = C_v \sqrt{\rho_i (p_i - p_o)}, \quad (\text{B.3})$$

where C_v is a valve constant, ρ_i and p_i are the density and pressure upstream the valve, while p_o is the pressure downstream.

When both phases are passing through the same orifice, the situation is more complex. However, vendors of valves typically give equations for this.

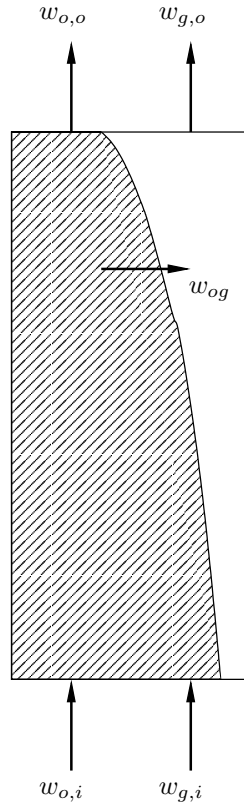

Figure B.1: Control volume

Nevertheless, the flow also in this situation is typically depending on the pressure difference between upstream and downstream the valve, and the densities upstream the valve.

Hence we need to calculate the pressure and density in the control volume as function of the masses of the phases, and the aim of this chapter is to get a simple relation for this based on a momentum balance for the control volume.

All parameters and variables describing the two-phase flow, are cross-sectional. The parameters and variables and variables are listed in Table B.1. Throughout the chapter, subscript g relates the property to the gas phase, and subscript o to the liquid (oil) phase. Subscript m means the property is related to the “mixture” of the two phases.

The height, which under homogeneous cross-sectional conditions parameterizes the variation of the variables of the well, is denoted with z . We assume

Symbol	Explanation	Unit
m	mass	kg
w	mass flow	kg s ⁻¹
q	volume flow	m ³ s ⁻¹
g	acceleration of gravity	m s ⁻²
ρ	density	kg m ⁻³
ν	specific volume	m ³ kg ⁻¹
p	pressure	Pa
g_m	mass flux	kg m ⁻² s ⁻¹
u_m	superficial velocity	m s ⁻¹
x	mass fraction	
α	void fraction	
Re	Reynolds number	
f	friction coefficient	
μ	viscosity	kg m ⁻¹ s ⁻¹
τ_w	friction force with wall	kg m ⁻¹ s ⁻²
S	circumference of	m ²
D	(equivalent) diameter	m
A	cross-sectional area	m ²

Table B.1: Parameters and variables describing the two-phase flow

that the pressure is the same for each phase at the same height, $p(z)$. The densities at height z are given as $\rho_g(z)$ and $\rho_o(z)$, while the mixture density is $\rho_m(z)$.

B.2 Pressure drop and hold-up

The flows entering and leaving the control volume will be a function of the properties of the fluid/gas at the control volume boundaries. In our case, we take the flows to be functions of the pressure, and in the out-flow case, also the density. We will take the density of the gas to be proportional to the pressure (which is true under the ideal gas law, for constant temperatures), and the oil/liquid to be incompressible. Since we use a mass-balances modeling approach, these pressures and densities must be found as a function of the masses in the control volume.

B.2.1 Solution approach: An illustrating example

The approach we will take to calculate the pressures is to set up a relatively simple ODE for the pressure/density profile for the control volume. To use this ODE, “initial conditions” must be found. The integral of the density profile over the volume equals the mass. If we assume we know the mass, the initial condition can in principle be solved from this equation.

To illustrate this, we consider a pipe filled with gas and ignore the flow effects (i.e., friction and acceleration):

Example B.1 *Gas only, friction and acceleration ignored* Consider a volume filled with gas only, and disregard friction and acceleration. Under the ideal gas law (assuming constant temperature along the pipe), the momentum balance is

$$-\frac{dp}{dz} = \frac{p}{RT}g. \quad (\text{B.4})$$

This ODE can (by separation of variables) easily be solved to

$$p(z) = p(z_0)e^{\frac{-g(z-z_0)}{RT}}, \quad (\text{B.5})$$

where z_0 is the height at the lowest point in the pipe. To calculate this pressure profile, we need the pressure at z_0 . This will be obtained from the mass of gas in the pipe, assumed known:

$$\begin{aligned} m_g &= \int_V \rho_g dV = A \int_{z_0}^L \rho_g(z) dy \\ &= A\rho_g(z_0) \int_{z_0}^L e^{\frac{-g(z-z_0)}{RT}} dy \\ &= A\rho_g(z_0) \frac{RT}{g} \left(1 - e^{\frac{-g(L-z_0)}{RT}}\right). \end{aligned}$$

This can be inverted, to obtain

$$\rho_g(z_0) = \frac{m_g g}{ART} \frac{1}{1 - e^{\frac{-g(L-z_0)}{RT}}}$$

which by the ideal gas assumption gives

$$p(z_0) = \rho_g(z_0)RT = \frac{m_g g}{A} \frac{1}{1 - e^{\frac{-g(L-z_0)}{RT}}}. \quad (\text{B.6})$$

Using (B.5), this gives

$$p(L) = \frac{m_g g}{A} \frac{1}{e^{\frac{-g(L-z_0)}{RT}} - 1}. \quad (\text{B.7})$$

The equations (B.6) and (B.7) give the pressure at the bottom and top of the pipe, and can be used to calculate the flow in to and out of the pipe.

In the gas lift example, the above equations can be used for the annulus (Section 6.6).

B.2.2 Basic variables and assumptions

For the multiphase case, when the volume is filled with both oil and gas, we will use simplified “homogeneous flow” equations (Taitel, 2001), summarized below. In doing this, we make a number of assumptions that typically do not hold true. Also, these assumptions “hold more” in a stable flow situation than in an unstable flow situation (for example, slug flow). It is important that a model reflects the dynamic effects that create these unstable flow situations, but the pressure profile needs not be calculated with a high degree of accuracy. It is useful, however, that it gives a good estimate in the stable flow situation.

Assumption B.1 *For calculating the pressure drop, we assume*

1. *cross sectional homogeneous conditions*
2. *the gas and the liquid has the same velocity*
3. *the mass fraction (x) and the mass flux (g_m) is constant in z , $dx/dz = dg_m/dz = 0$*
4. *the ideal gas law holds*
5. *incompressible oil*
6. *constant temperature in the volume*

The momentum (force) balance for the mixture can be written (Taitel, 2001)

$$-\frac{dp(z)}{dz} = \frac{S}{A}\tau_w(z) + g_m(z)\frac{du_m(z)}{dz} + \rho_m(z)g \quad (\text{B.8})$$

assuming the spatial coordinate z positive upwards¹. In words, the pressure loss is given by the friction loss (first term), acceleration loss (second term) and hydrostatic pressure loss (gravity, last term). For the applications considered herein, the acceleration loss can be disregarded, but it is kept for

¹If the gravity term is written as $\rho_m g \sin \beta$, this holds for both vertical and inclined pipes (β inclination angle).

completeness. The momentum balance will be used to calculate a pressure profile at a given time, assuming the column “frozen in time”, making it an ODE.

Before we develop (B.8) further, we introduce some central terms. The background material used on multi-phase flow modeling, are found in Taitel (2001).

Void fraction The composition of the mixture will vary along the volume. Define the (cross sectional) void fraction at height z (the mass fraction of gas) as $\alpha(z)$ (the hold-up is then $1 - \alpha(z)$). The mixture density at a given height is then given as

$$\rho_m(z) = \alpha(z)\rho_g(z) + (1 - \alpha(z))\rho_o(z) \quad [\text{kg/m}^3]. \quad (\text{B.9})$$

Friction At this level of modeling, we must use a correlation for the friction τ_w (shear stress) with the wall. Widely used is

$$\tau_w = f \frac{\rho_m u_m^2}{2} \quad (\text{B.10})$$

where the constant f is a function of the Reynolds number for the mixture,

$$f = f(\text{Re}_m) \quad \text{where} \quad \text{Re}_m = \frac{\rho_m u_m D}{\mu_m} \quad (\text{B.11})$$

where μ_m is the mixture viscosity.

Superficial velocity For both the friction part and the acceleration part, we need to obtain the superficial velocity u_m . The velocity at height z , denoted $u_m(z)$ is the sum of each of the phases (cross sectional) volumetric flow rate

$$u_m(z) = \frac{1}{A}(q_o(z) + q_g(z)) \quad [\text{m/s}]. \quad (\text{B.12})$$

Mass fraction Denote the (cross sectional) mass fraction (or quality) at height z with $x(z)$. It is defined as

$$x(z) := \frac{w_g(z)}{w_o(z) + w_g(z)} \quad (\text{B.13})$$

Under the assumption that the velocity of the gas and the oil is the same, the following holds:

$$x(z) = \alpha(z) \frac{\rho_g(z)}{\rho_m(z)} = 1 - (1 - \alpha(z)) \frac{\rho_o}{\rho_m(z)} \quad (\text{B.14})$$

From this, we deduce²

$$\frac{1}{\rho_m} = \frac{x}{\rho_g} + \frac{1-x}{\rho_o} = x(\nu_g - \nu_o) + \nu_o$$

and

$$\alpha = x \frac{\rho_m}{\rho_g} = \frac{x\nu_g}{x(\nu_g - \nu_o) + \nu_o} = \frac{x}{x + (1-x)\frac{\rho_g}{\rho_o}} \quad (\text{B.15})$$

where ν_g, ν_o are the specific volumes. Since $dx/dz = 0$, we can find $x(z) = x$ from the total mass fraction. From equation (B.13), we have that

$$\begin{aligned} \rho_m(z)x &= \alpha\rho_g(z) \\ (\alpha(z)\rho_g(z) + (1-\alpha(z))\rho_o)x &= \alpha(z)\rho_g(z) \\ x \int_{z_0}^L A(\alpha(z)\rho_g(z) + (1-\alpha(z))\rho_o) dz &= \int_{z_0}^L A\alpha(z)\rho_g(z) dz \\ x(m_g + m_o) &= m_g \end{aligned}$$

which shows that

$$x = \frac{m_g}{m_g + m_o}. \quad (\text{B.16})$$

The assumption $dx/dz = 0$ can in the steady flow situation be interpreted as “no mass transfer between phases”.

Mass flux The mass flux g_m (assumed constant) is defined by

$$g_m = \frac{w_o + w_g}{A} \quad [\text{kg}/(\text{m}^2 \text{ s})]. \quad (\text{B.17})$$

The superficial velocity is given from the mass flux as

$$u_m = \frac{g_m}{\rho_m} = g_m(x(\nu_g - \nu_o) + \nu_o). \quad (\text{B.18})$$

Note that even though we assume $dg_m/dz = 0$, $du_m/dz \neq 0$ in general.

The mass fraction x can be found from the masses, see (B.16). The mass flux g_m can be found from the flows, see (B.17), but the flows are (typically) not known until the pressure is calculated. However, the mass flux enters only the friction and acceleration part of the ODE (B.8), which are typically much smaller than the gravity part. Therefore, we will use the following, very approximate, formula for computing the mass flux:

$$g_m = \frac{w_{o,nom}}{A(1-x)} \quad (\text{B.19})$$

²We drop the dependence on z from here onwards, when the dependence can be concluded from the context.

where $w_{o,nom}$ is a nominal oil flow (production). This means that g_m will be correct (under the assumptions made) under “nominal conditions” (a desired stable flow condition), but wrong under non-nominal conditions.

B.2.3 Density/pressure profile ODE

By using the above variables, we will formulate (B.8) as an ODE for given x and g_m :

$$\begin{aligned} -\frac{dp}{dz} &= \frac{S}{A}\tau_w + g_m \frac{du_m}{dz} + \rho_m g \\ &= \frac{S}{2A} f g_m^2 (x(\nu_g - \nu_o) + \nu_o) + g_m^2 \frac{d}{dz} (x(\nu_g - \nu_o) + \nu_o) + \frac{g}{x(\nu_g - \nu_o) + \nu_o} \end{aligned}$$

Here, we will assume that the ideal gas law holds, which implies that the pressure is proportional to the gas density under constant temperature, $p = \rho_g RT$. We have several choices of which variable we want to represent the spatial (one-dimensional) pressure profile. Obvious choices are $p(z)$, $\rho_g(z)$ and $\nu_g(z) = 1/\rho_g(z)$. As a first try we will, however, look at using $\nu_m(z) := x(\nu_g(z) - \nu_o) + \nu_o = 1/\rho_m(z)$ (for reasons that will become apparent), and try the same procedure as in Example B.1.

Noting that

$$\begin{aligned} \frac{dp}{dz} &= RT \frac{d\rho_g}{dz} \\ &= RT \frac{d}{dz} \frac{x}{\nu_m - \nu_o(1-x)} \\ &= \frac{-xRT}{(\nu_m - \nu_o(1-x))^2} \frac{d\nu_m}{dz}, \end{aligned}$$

the ODE becomes

$$\begin{aligned} RT \frac{x}{(\nu_m - \nu_o(1-x))^2} \frac{d\nu_m}{dz} &= \frac{S}{2A} f g_m^2 \nu_m + g_m^2 \frac{d\nu_m}{dz} + \frac{g}{\nu_m} \\ \left(RT \frac{x}{(\nu_m - \nu_o(1-x))^2} - g_m^2 \right) \frac{d\nu_m}{dz} &= \frac{S}{2A} f g_m^2 \nu_m + \frac{g}{\nu_m}. \end{aligned}$$

Rearranging, this gives us a quadrature type (an integral in disguise) ODE,

$$\frac{d\nu_m}{dz} = F_{\nu_m}(\nu_m). \quad (\text{B.20})$$

This ODE can be solved numerically by e.g. ODE solvers in MATLAB like `ode23.m`, but is not easily solved symbolically. However, the ODE can often (specifically, for the well considered in Section 6.6) for typical flowing

conditions be approximated with an ODE of the form

$$\frac{d\nu_m}{dz} = a\nu_m^3 + b\nu_m,$$

for given a and b . This ODE is easily solved symbolically using software like Maple. Writing the solution as

$$\nu_m(z) = \nu_m(z; \nu'_m),$$

we can find the “initial condition” ν'_m by integrating

$$m_g = A \int_{z_0}^L \alpha(z) \rho_g(z) dz = A \int_{z_0}^L \frac{x}{\nu_m(z; \nu'_m)} dz.$$

However, even though this integral is solvable (again using Maple), it is not possible to find a closed form solution for the initial condition ν'_m .

We therefore try a slightly different approach, using the mixture density as variable, $\rho_m = 1/(x(\nu_g - \nu_o) + \nu_o)$. The pressure gradient is then

$$\begin{aligned} \frac{dp}{dz} &= RT \frac{d\rho_g}{dz} \\ &= RT \frac{d}{dz} \frac{x\rho_m}{1 - \nu_o(1-x)\rho_m} \\ &= \frac{xRT}{(1 - \nu_o(1-x)\rho_m)^2} \frac{d\rho_m}{dz}, \end{aligned}$$

and the ODE becomes

$$\begin{aligned} -\frac{RTx}{(1 - \nu_o(1-x)\rho_m)^2} \frac{d\rho_m}{dz} &= \frac{S}{2A} f g_m^2 \frac{1}{\rho_m} - g_m^2 \frac{1}{\rho_m^2} \frac{d\rho_m}{dz} + g\rho_m \\ \left(\frac{-RTx}{(1 - \nu_o(1-x)\rho_m)^2} + g_m^2 \frac{1}{\rho_m^2} \right) \frac{d\rho_m}{dz} &= \frac{S}{2A} f g_m^2 \frac{1}{\rho_m} + g\rho_m. \end{aligned}$$

The “dynamic” parameters (parameters that changes in time and characterizes the solution of this ODE) is apparently x and g_m . However, in addition to x we must also consider m_g (or m_o), that will enter through the initial conditions as explained above³.

Solving the above ODE numerically for different g_m , x and m_g for a typical well⁴, reveals that for large (relevant) ranges of these parameters, $\rho_m(z)$ is close to linear in z . The following approximations are good as long

³Of course, in stead of g_m , x and m_g/m_o , one can use g_m , m_g and m_o .

⁴The same that will be considered in Section 6.6

as this linearity property holds approximately. Since the “bias” for the linear approximation is found from the (known) mass, it can also be view as an averaging approach.

Writing the ODE as

$$\frac{d\rho_m}{dz} = F_{\rho_m}(\rho_m; x, g_m),$$

a linear approximation (at the point z') is straightforwardly given as

$$\rho_m(z) = F_{\rho_m}(\rho_m(z'); x, g_m)(z - z') + \rho_m(z').$$

However, it remains to find $\rho_m(z')$ (and choose z'). This is obtained by integrating

$$\begin{aligned} m_g &= A \int_{z_0}^L \alpha(z) \rho_g(z) dz = Ax \int_{z_0}^L \rho_m(z; \rho_m(z')) dz \\ &= xA \left[\frac{1}{2} F_{\rho_m}(\rho_m(z'); x, g_m) z^2 + (\rho_m(z') - F_{\rho_m}(\rho_m(z'); x, g_m) z') z \right]_{z_0}^L \end{aligned}$$

which, in taking $z' = \frac{L}{2}$ and $z_0 = 0$,

$$= xAL\rho_m(z').$$

This gives

$$\rho_m(z') = \frac{m_g}{xAL}.$$

This is (of course) nothing else than the average mixture density of the column, $\rho_m(z') = \bar{\rho}_m = (m_g + m_o)/V$. The mixture density at the top and bottom of the column, is by the linearity assumption found as

$$\begin{aligned} \rho_m(0) &= \rho_m(z') - F_{\rho_m}(\rho_m(z'); x, g_m) \frac{L}{2} \\ \rho_m(L) &= \rho_m(z') + F_{\rho_m}(\rho_m(z'); x, g_m) \frac{L}{2}, \end{aligned}$$

and we find gas density and pressure

$$\begin{aligned} \rho_g(0) &= \frac{x}{\frac{1}{\rho_m(0)} - \nu_o(1-x)}, & p(0) &= \rho_g(0)RT, \\ \rho_g(L) &= \frac{x}{\frac{1}{\rho_m(L)} - \nu_o(1-x)}, & p(L) &= \rho_g(L)RT. \end{aligned}$$

These are the expressions used in the simple model in Section 6.6.